

2023 | 2024



ONE SUPPLIER, ENDLESS POSSIBILITIES



BUYERS GUIDE

WE'RE YOUR COMPLETE PACKAGING PARTNER

NATIONAL COVERAGE • OVER 40 YEARS EXPERIENCE

Take advantage of our dedicated
EQUIPMENT SERVICE TEAM.
Experienced in troubleshooting and
repairing all makes and models of
rollstock and vacuum chamber machines.

**LOWEST LABOR RATES
IN THE INDUSTRY**

800-888-3610

PREVENTIVE MAINTENANCE MATTERS

*Available to any customer with an estimated labor cost of \$1,100 — excluding cost of parts and travel expenses.
Service normally takes about 10 hours to complete — depending on the condition of the machine and availability of parts.*

- Operate faster and with fewer interruptions providing quality and consistency.
- Provides higher safety standards in food safety.
- Reduces costly repairs later.
- Detailed maintenance records as evidence of safety standards.
- Make the most of your investment.

Service will be billed as an hourly rate with a four-hour minimum. Travel expenses will also be billed which would include: travel time, air travel, rental car, lodging and a daily meal allowance.
If the service personnel drives to the customer's location, travel time plus mileage charges will apply.

TABLE OF CONTENTS

Ordering Information and Terms and Conditions	2-3
About BPD	4-5
Go Green	6
Buy Pink	7
Game Season	8-9
WorkHorse® Products	10-11

CLOTHING

Boot Comparison Chart	12
Boots, Work Shoes and Accessories	14-23
Insoles, Socks and Boot Liners	24-25
Boot Racks and Wash Stations	25-27
Overshoes and Overboots	29
Shoe and Boot Covers	30-31
Insulated Clothing and Gloves	32-39
Gloves	39-66
Thermal Hand Protection	42-44
Disposable Gloves	63-66
Sleeves	67
Bouffant Caps, Hairnets and Beard Guards	69-71
Aprons, Gowns and Disposable Clothing	73-84
Work Clothes and Frocks	84-87
Rainwear and Acid Suits	88-93

CLEANING/HYGIENE

Brushes, Squeegees, Scrapers and Handles	96-111
Brooms and Dust Pans	112-115
Dust Mops, Mops and Accessories	116-121
Sponges, Ceiling/Floor Brushes and Access.	122-126
Cleaning/Scouring Pads	127-128
Disposable Rags and Wipes	129-131
Sanitizers, Degreasers and Cleaners	133-144
Spray Bottles, Pumps and Boot Dip Mat	145
Nozzles, Adapters, Hoses and Mixing Stations	146-154
High-Pressure Washers and Nozzles	155-156
Foamers and Sanitizing Systems	157-160
Hand Soaps, Sanitizers and Dispensers	161-169
Lavs, Sinks and Accessories	170-177
Sterilizer Boxes and Heating Elements	178-179
Paper Towels, Tissue and Dispensers	180-183
Ozone Machines	183
Restroom Cleaners and Supplies	184-185

MATERIAL HANDLING

Totes, Platters and Dollies	188-203
Steamer Pans, Food/Dough Boxes and Dollies	204-207
Ingredient Bins	208-209
Utility Carts, Platform, Hand and Tilt Trucks	210-217
Storage and Combo Bins	218-221
Combo Caps, Liners and Bands	222
Pallets, Skids and Freezer Spacers	223-225
Ergo Stands and Dunnage Racks	226-227
Shelving and Storage Cabinets	228-230
Stainless Steel Buggies, Trucks and Pails	231-232
Receiving Desk and Stool	233
Work Tables, Table Tops and Cutting Boards	234-237
Wheels and Casters	238-241
Mixing Paddles, Forks and Shovels	242-247
Scrapers, Scoops and Food Containers	248-253
Color-Coded Buckets, Pails, Jugs and Accessories	254-256
Drums, Trash Cans, Liners and Accessories	256-263

ERGONOMICS

Back, Wrist and Elbow Supports	266-268
Knee Pads	269
Floor Grating and Ergo Stands	269
Floor Mats and Accessories	270-271

SAFETY

Squincher Hydration Mix	274
Lockout/Tagout	276-279
Padlocks and Security Locks	279-280
Anti-Slip Tapes and Compound	280-281
First Aid Kits and Medical Supplies	282-289
Eye Protection and Accessories	290-299
Ear Protection and Accessories	299-310
Head Protection and Accessories	311-314
Fall Prevention	314-315
Hi-Viz Safety Vests	316-317
Respirators and Masks	318-324
Cut Resistant Gloves, Aprons and Sleeves	326-335
Welding Protection	336

CUTLERY

Knives and Block Sets	340-369
Game Season Knives	366-367
Knife Cases, Racks, Scabbards and Sheaths	369-371
Hooks and Hand Tools	372-374
Shears	375-379
Steels	380-383
Manual Sharpeners	384-386
Electric Sharpeners	387-389
Oilstone Sharpeners and Accessories	390-391
Utility Tools and Knives	392-395

BLADES

Grinder Plates and Knives	398-399
Bandsaw Blades	400-402
Tray Pack Blades	403
Circular Blades	404-405
Specialty Blades	406-411

PROCESSING

Jarvis® Stunners and Accessories	414-425
Body Protection, Rattle Paddles and Cattle Prods	426-427
Dehidrs, Skinners and Circular Saw	427-428
Packers Kromer™ INOXPRO® Balancers	429
Wellsaws, Breaking Saws and Bandsaws	430-435
Rail Switches, Trolleys, Hooks and Gambrels	436-440
Weasand Clips, Rods, Plugs and Pliers	441
Tagging Systems and Marking Supplies	442-443
Handsaws and Hand Tools	443-444
Hog Scrapers, Paddles, Whips and Supplies	444-445
Plumatech Diaphragms and Plucking Fingers	445-447
Stamps and Tattoo Accessories	448-449
Sanitary Gaskets and O-Rings	449
Skinners Rollers, Pinch Blocks, Cones and Rings	450

FURTHER PROCESSING

Seasonings, Spices, Marinades and Rubs	452-457
Cures, Pumps and Accessories	458-461
Injector Needles	462-463
Food Slicers and Grinders	464
Casings	465-468
Tabletop Piston Stuffer	469
Netting and Zip Tyers	470-471
Smokehouse Supplies	472-473

PACKAGING

Vacuum Pouches and Accessories	476-479
Bone Shields/Guards and Food Safe Markers	480-481
Shrink Bags and Rollstock	482-488
Lidding and Vacuum Skin Packaging	489
Modified Atmosphere Bags	490
Cook Chill Bags, Sealers and Accessories	490-491
Poly Bags and Accessories	492-495
Locker Paper, Cutters and Tape	496-497
Film Wrap and Dispensers	498
Trays, Soaker Pads and Labels	499
Shrink Film and Low-Density Poly Bags	501
Film Dispensers, Twist Ties, Twine and Clips	502
Deli Paper, Foil, Meat Boats and Resealable Bags	503-504
Sacks, Cups, Shopping Baskets and Gel Packs	505

QUALITY CONTROL

Pens, Clipboards and Calculator	509-510
Stopwatches and Timers	510
Whirl-Pak® Bags and E. Coli Test Kit	511
OXYBABY® Gas Analyzer and Test Strips	512
pH Meter, Fat Analyzer and Test Kits	513

SCALES

Digital Scales	516-518
Bench, Hanging and Dial Scales	519-520
Calibration Weights	520

THERMOMETERS

Digital Thermometers	525-529
Bi-Metal and Dial Thermometers	529-531
Wall Thermometers and Probe Wipes	532
Infrared and Specialty Thermometers	533
Calibration Devices and Recording Thermometers	535-537

PLANT REMODELING

Strip, Curtains, Mesh, Air and Roll-Up Doors	540-544
Flexible and Traffic Doors	545-548
Interior and Cold Storage Doors	549-551
Light Bulbs and Fixtures	552-556
Ceiling Panels and Wall Covering Systems	557-559
Floor Coatings	560
Lockers, Bollard Covers and Benches	561
Banner Stakes	562

PLANT MAINTENANCE

Flashlights and Batteries	564-566
Utility Brushes, Bottles and Wipes	567
Tapes, Coating and Compounds	568
Ladders and Work Carts	570-571
Blowers and Fans	572-573
Lubricants and Oils	574-576
Drum Pumps and Faucets	577
Absorbents and Soaker Pads	578-580
High Capacity Filters	580
Sprayers and Insect Control	581-583
Door Gaskets, Sealants and Adhesives	584
Ergo Stands and Floor Grating	585

SHIPPING

Tape and Dispensers	588-590
Twine, Twine Accessories and Stretch Film	591
Hot Melt Adhesive	592
Utility Knives	593
Strapping and Accessories	594
Dock Bumpers, Chocks and Load Bars	595
Pens and Markers	596

ORDERING IS EASY:

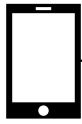

Phone Orders

800-456-5624

- Monday - Friday.
- 7:00 AM - 5:30 PM CST.
- Knowledgeable sales staff.



Fax Orders

800-329-5624

- Order 24/7

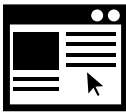

Online Orders

www.bunzlpd.com

- Order 24/7 • Real time pricing.
- Secure.



Email Orders

kochsupplies@bunzlusa.com

- Order anytime.

Need Assistance?

Whether you have a rush order or need to arrange regular shipments, you can count on us for the friendliest, most dependable service. Our experienced staff will answer your questions on pricing, product availability and any other technical questions you may have, as well as take your order.



BUNZL PROCESSOR DIVISION'S PRICE MATCH GUARANTEE*

WE'LL GLADLY MATCH ANY COMPETITOR'S
ADVERTISED PRICE ON MATCHING PRODUCT.

* **What qualifies?** Your product may be eligible for price matching if it is: Identical to the competitor's product. The product must be a matching brand, model number and color to qualify. The product must also be a new product. Immediately available at a qualifying retailer or competitor. We match local competitors (including their online prices) and qualifying online competitors. Exclusions apply including, but not limited to, items sold by Marketplace vendors, competitors' service prices, special daily or hourly sales, and items for sale the Friday before Thanksgiving Day through the Monday after Thanksgiving. **WE WON'T BE BEAT ON PRICE.** We'll match the product prices of key competitors for immediately available new products (excludes clearance, refurbished and open-box items).

Special considerations:

- At the time of sale, we price match all local competitors (including their online prices).
- One price match per identical item, per customer, at the current pre-tax price available to all customers is allowed.

Our Price Match Guarantee does not cover:

- The online prices of retailers not listed in the Special considerations section.
- Products shipped from or sold by third-party sellers on websites.
- Pricing only available to select groups of customers including Membership Program members, loyalty offers, discounts relating to non-warehouse membership or paid loyalty programs and government exchange store offers.
- Competitor offers including liquidation offers, trade-in offers, items denoted as Black Friday pricing and special daily or hourly sales.
- Any financing offers, bundle offers, items included in bundle offers, subscription services, free items, pricing errors, mail-in offers, coupon offers, items that are advertised as limited quantity, out of stock items, clearance items, open-box items, refurbished items, pre-owned items, voice-only deals, and items for sale the Friday before Thanksgiving Day through the Monday after Thanksgiving, whether offered by us or a competitor.

WATCH FOR THESE SYMBOLS:



These products are non-stock or special order and may require additional shipping time or fees.



Products marked with this image are eco-friendly and environmentally safe.



Product complies with HACCP regulations.



Products made in the USA.



Shipped by truck freight. Freight rates are available when ordering.



Certain items in this catalog are not returnable and have a NO RETURN symbol next to them.



You can find SDS sheets on our products at <https://bunzlnasds.appsint.com/SDSLibrary/>



These items are exclusive to Bunzl Processor Division.



These products are considered hazardous materials and therefore could require special shipping. Call for details.



Scan QR codes with your mobile device for direct links to websites, videos and much more.



Thoroughly read and understand all safety instructions before attempting to use this product.



WARNING: Some products in this catalog may expose you to chemicals including DEHP Di (2-ethylhexyl) phthalate or BPA (Bisphenol A) which are known to the State of California to cause cancer or birth defects or other reproductive harm. For more information, visit www.P65Warnings.ca.gov.

TERMS & CONDITIONS

Prices

Prices in this catalog are current prices at publication and are subject to change without notice. In the rare event of a printing error, we reserve the right to charge the correct price. Confirm current prices and availability by phone, fax, or e-mail. Prices are in U.S. dollars and do not include applicable taxes. Current up-to-date pricing can be found on our website www.bunzlpd.com.

Payment Terms



We accept Visa®, MasterCard®, American Express®, Discover® and checks. We offer credit terms of Net 10 days for customers with a minimum monthly volume of \$500, subject to credit approval.

International Customers

Please contact us directly for a “pro forma quotation” with current pricing, appropriate freight, duty, taxes and clearance costs.

Payments may be made in U.S. dollars, Visa®, MasterCard®, American Express®, Discover®, bank transfer, or irrevocable Letter of Credit confirmed by any U.S. bank. Include the invoice number with all payments.

Note: Some items are not available to be shipped outside of the U.S. Check with your sales representative for details.

Specification Changes

Due to continuing improvements, product specifications and pricing are subject to change without notice.

Discounts

Discounted prices for certain catalog items purchased in quantity do not apply to orders shipped outside the United States.

Satisfaction Guarantee

When purchasing from our catalog, you can rest assured that any product you order will meet your expectations — guaranteed! That’s a promise from our friendly and knowledgeable Customer Service Representatives. However, in the rare case that any stocked supply item fails to meet with your expectations or approval, simply call our toll free number within 30 days and we can arrange for a repair, refund, exchange or credit towards your next purchase, except for those items noted as “No Return” items.

Call for warranty information on non-stock or special order items (i.e. equipment, doors, walls, etc.).

Note: A restocking or repair fee may apply on certain special order items.

Shipping

Unless specified, we will determine the most expedient and efficient means of shipment based on dimensional weight - UPS or LTL (less than truckload). Alternate delivery may require additional cost. Appropriate charges will be added to your invoice.

Bunzl Processor Division will not be liable for any claim, loss, or damage caused in whole or in part due to delay in or failure to make delivery when such delay or failure is directly or indirectly caused by act of God; strike or other labor difficulty; transportation problems; accident; act of any civil or military authority; act of war; or act of purchaser; or by the occurrence of any other contingency beyond Bunzl Processor Division’s reasonable control.

Receiving/Claims

It is the buyers responsibility to thoroughly inspect shipments upon receiving.

Prior to signing for your items, check the number of packages received, as well as the condition of the product. Failure to do so will negate the ability to claim damages. Notification of short shipments or damage must occur within 2 business days of receipt of product for credit to be considered.

Report the details immediately to our Customer Service Department by calling **800-456-5624**. Keep the carton and all packing materials. Notify shipper of shortage or obvious damage at time of delivery.

Returns

Please call our Customer Service Department to obtain a return authorization number before returning items. When you call, please provide us with the following:

- BUNZL reference number (on packing slip) or invoice number
- Your purchase order number
- Date of purchase
- Reason for return



All items returned due to duplication or a change of need must be in unused, resalable condition and in its original packaging — within 30 days. Returned items may be subject to a restocking fee. Items returned due to damage occurring during shipping or defective products must be packaged so no further damage occurs.

Note: Returns without prior return authorization will be charged a re-stock fee and may be refused.

Note: Certain items in this catalog are not returnable and have a NO RETURN symbol next to them.

Some of these items include direct food contact items such as: casings, seasonings, packaging products, etc, medicines and medical supplies, certain chemicals, or coatings, stunner loads and solvents.

Confirming Orders

Please do not send a confirming order. If in your system you must send a confirming order, please mark it clearly as confirming to avoid duplication of orders sent.

FREE SHIPPING*
FREE GROUND SHIPPING
 when you place an order for \$500 or more from
THIS BUYERS GUIDE!

*FREE SHIPPING does NOT include UPS Next Day Air, UPS 2nd Day or UPS 3rd Day Select. Certain items may not qualify. This offer is good only on orders shipped UPS Ground in the 48 contiguous states. Based on dimensional weight, we will determine the most efficient means of shipment, either UPS or LTL. Products may ship by truckline.



Bunzl Processor Division (BPD)

BPD is a leader in the food processing and food packaging industries that services national platforms, as well as multi-plant, single-plant, small shops and game processors. Bunzl offers an assortment of high-quality products designed specifically to meet the needs of the food service and food processing industry, under a private label product line called Prime Source®, as well as a myriad of branded exclusive products specific to the food processing industry such as EdgeMaster™ bandsaw blades, the ToteAll 2000® material handling system, WorkHorse® protective wear, Processor's Choice Cures, Clarity™ Flexible Packaging options and many more. With more than 35,000 different supply items and 14 distribution centers serving Central and North America, including the Caribbean and Mexico, Bunzl Processor Division is an integral part of Bunzl Distribution Inc.

The Industry's Most Extensive Line of Flexible Packaging

Bunzl Processor Division's line of packaging supplies is comprised of the most recognized, trusted and valued brands in the industry. BPD offers our Clarity™ line of Cryovac® Shrink Bags and Clarity™ Rollstock Film for your forming and non-forming applications. Just call one of our packaging specialists and we'll do a no-charge, no-obligation review of your films. And if you choose BPD to be your supplier, we'll gladly stock all of your film sizes to reduce lead times and cost outlays for your business. Interested in Clarity™ Vacuum Pouches? BPD can produce any size bag you need – with lower costs, faster lead times and consistent, American-made quality. BPD also stocks a full line of meat bags, cook chill bags, poly bags and locker paper. Just give us a call for any of your packaging needs!

Customer Service From People Who Care

Bunzl Processor Division establishes close relationships with our vendors and because of this our representatives are experts on all the products that we sell — giving them a professional working knowledge of how these products best serve the food processing industry. Whether you have a rush order or need to arrange regular shipments, you can count on us for the friendliest, most dependable service. Our experienced team will answer your questions on pricing, product availability and any other technical questions you may have, as well as take your order.

We Stock What We Sell

Bunzl Processor Division is a leading distributor of plant operating supplies for the meat and food processing industry — offering such product categories as clothing, janitorial, sanitation, material handling, plant remodeling, safety, cutlery, scales, thermometers, processing supplies, seasonings, packaging as well as maintenance, repair and operation supplies (MRO). **Our inventory includes over 35,000 items**, so you don't have to wait long to receive the supplies you need. We are committed to getting your order shipped to you fast and complete — it's that simple!

Easy Order Placement



PHONE: Call **1-800-456-5624** Monday - Friday, 7 AM - 5:30 PM CST and a member of the industry's most knowledgeable staff will be happy to assist you.

También ofrecemos asistencia al cliente en español. Llame al **1-800-746-7990** para contactar a nuestro Departamento de Exportación o uno de nuestros representantes bilingües.



FAX: You can fax your order to **1-800-329-5624**.



ONLINE: Try out our convenient, easy-to-use online catalog. It has all your ordering needs in one place. Order online at **www.bunzlpd.com** 24/7. It's fast, easy and secure.



EMAIL: You can email your order anytime to **kochsupplies@bunzlusa.com**



Payment options are easy as well — charge your order to any Visa®, Master Card®, American Express® or Discover® card. In addition, we accept checks over the phone and open credit terms are also available.



Why 'Call for Pricing'? With product availability and costs fluctuating due to supply chain sourcing, you will see certain products displayed without a price in this Buyers Guide and instead are listed as Call for Pricing. On such items, please call our Customer Service team at 800-456-5624 or visit our website at www.bunzlpd.com where pricing is always up to date.

FOR EASY ONLINE SHOPPING, VISIT WWW.BUNZLPD.COM



Scan this QR Code with your smart device to watch a video about our website features!



- **Quick Order Products**
 - **Re-Order Products**
 - **Product Comparison**
 - **Advanced Search**
 - ♥ **Add Products to Favorites**
 - **Product Reviews**
- Outstanding Overstock Deals**

SIGN UP FOR OUR
eDEALS 

eDEAL SIGN-UP FORM
AVAILABLE ON OUR WEBSITE.

Shop our website 24/7!
It's the best way to always find current pricing.



Our website will allow you to easily navigate through all of our key product categories and our search filters will allow you to narrow your product selection down by brand, price, product features and more!

Quick Order:

As a logged-in user, you can quickly and easily add products to your shopping cart if you know the item numbers you'd like to order. Simply select the 'Quick Order' link at the top of the home page.

Re-Order:

As a logged-in customer that has ordered before, you can easily re-order those same products, with a simple click of a button.

Product Comparison:

Having a tough time deciding between a few similar products? Our Product Comparison feature is here to help. Simply add the products you'd like to compare and then choose 'Compare', which allows you to see the products side-by-side.

Advanced Search/Navigation:

Our search filters help you narrow down your product selections to help you find what you're looking for easier and quicker than ever.

Favorites:

Logged-in users can choose to 'Favorite' a product, which will store it in your 'Favorites' ♥ list. This can be used to store frequently ordered products, so they are quick to find. It can also be used to mark products for future purchasing.

Product Reviews:

You can leave reviews on products you've purchased and tried out. You can also read reviews from other users to have a better idea how the product has been viewed by others who have tried it.

GO GREEN

ECO-FRIENDLY AND ENVIRONMENTALLY CONSCIOUS.

Enviro Terra™ Acid Replacement Cleaner

A totally natural cleaner that combines the high performance of acids with the mildness of liquid dish soap.

- Contains the same cleansing power of acids, without the unpleasant side effects such as skin burns and invisible toxic fumes.
- Effectively removes calcium, lime, rust and other deposits typically found in descaling and rust removal applications.
- Does not have to be shipped, handled, stored or disposed of as a hazardous material. In fact, it is biodegradable and non-corrosive.
- Special clinging action allows longer dwell time on vertical surfaces – easily cleaning complex surfaces like piping, valves and crevices without leaving film or residue.
- Perfect product for manufacturing equipment, building maintenance, food services and washrooms.
- Non-toxic, non-corrosive, non-fuming, non-caustic and non-flammable.



Safe on skin.



Can be applied with an industrial foamer.

▶ 6 BOTTLES PER CASE.

ITEM NO.	PRODUCT	GALLON
2117 01351	1-Gallon Bottle.....	\$27.01

Universal Super Absorbent

The safe, easy and economical spill clean up.

- Absorbs 7-1/2 times more than clay – up to 14 gallons/box.
- More economical than paper towels.
- Accepted by landfills – non-leaching.
- Absorbs oil and water based liquids.
- Quick absorption for fast clean up.
- Non-toxic and environmentally friendly.
- Leaves surface dry and slip free.
- Meets USDA, FDA and EPA requirements.



XSORB Spill Clean-Up

- Plastic bottles with screw-on caps.
- Refilling the bottles using the 25-pound box is simple and easy, saves time, money and the environment.



▶ 4 BOTTLES PER CASE.

ITEM NO.	PRODUCT	WT.	CASE
6017 0036	6 qt. Bottles.....	10 lb.....	\$54.86

ITEM NO.	PRODUCT	BOX DIMENSIONS	BOX
6017 0025	25 lb Box.....	16-1/2" x 14" x 22-1/4".....	\$38.54

GOJO® MULTI-GREEN® Hand Cleaner

- Multi-purpose hand cleaner removes light to medium industrial soils and dirt.
- Contains a natural, citrus solvent cleaner and non-abrading scrubbing particles.
- SANITARY SEALED™ refill helps prevent contamination.



▶ SEE PAGE 165
For Manual Dispensers



ITEM NO.	PRODUCT	CASE
3540 0018	2,000 mL Multi-Green (4/case) ...	\$110.79
3540 0042	5,000 mL Multi-Green (2/case) ...	173.93

GOJO® Green Certified Foam Hand Cleaner

Be environmentally responsible without sacrificing product performance.

- A mild, biodegradable foam soap formula certified by Green Seal™ and EcoLogo^{CM} to meet their joint standard (GS-41/CCD-104) for hand cleaners and hand soaps.



ITEM NO.	PRODUCT	EACH
3540 15021	7.5 fl. oz.	\$6.23

Knit Eco-Gloves®

Go 'green' with Eco-Gloves® – made from recycled post-consumer plastics.

- Using EarthSPUN™ green-certified technology, recycled plastic bottles are processed into fibers that are used to create Eco-Gloves®.
- One size. • Stain-resistant. • Knit wrist.
- Recycled fibers shrink less than normal gloves, extending life of glove.



Made from recycled plastic bottles.



▶ 40 DOZEN PAIR PER CASE.

ITEM NO.	PRODUCT	DOZEN PAIR
7419 70075	Gray.....	\$11.45

SHOW YOUR SUPPORT
FOR BREAST CANCER
AWARENESS

BUY PINK

Eva® Scratch Resistant Safety Glasses

- Smaller and narrower frame design with pink accents.
- Narrow saddle nose bridge design.
- Thin, flexible temples provide secure fit without pinching.
- Meets ANSI Z87.1+ standard.



For More Details ▶ SEE PAGE 296

▶ 12 PER CASE.

ITEM NO.	PRODUCT	EACH
6292 09001	Regular, Clear, Scratch-Resistant Lens	\$6.35

Pink Eyewear Strap

- Mono slide adjusts for the perfect fit.
- Rubberized sleeves tightly hold eyewear.
- Strap length: 22 inches.



For More Glasses Accessories ▶ SEE PAGE 296

▶ 12 PER CASE

ITEM NO.	PRODUCT	EACH
3425 53231	Pink Eyewear Strap	\$2.95

Pink Safety Vest

- Made of polyester fabric.
- Hook and loop closure.
- Elastic side straps.
- No pockets.
- One size fits all.
- Solid color w/silver reflective stripes.



For More Safety Vests ▶ SEE PAGES 316-317

ITEM NO.	PRODUCT	EACH
3425 17281	Safety Vest	\$8.30

 **BROWSE THROUGH THIS BUYERS GUIDE TO FIND MORE PINK PRODUCTS**

"Little Vicky" Paring Knife

- Straight blade: 3-1/4 inch.
- Polypropylene handle.



▶ SEE PAGE 362-363 For More Paring Knives

▶ 12 PER CASE.

ITEM NO.	PRODUCT	EACH
3367 61151	Pink Handle, Little Vicky Paring Knife	\$6.34



WARNING: Cancer or reproductive harm. www.P65Warnings.ca.gov. See page 2 for details.

WorkHorse® Pink Bouffant Caps



- Cool and comfortable to wear.



▶ 100 PER BAG - 10 BAGS PER CASE.

ITEM NO.	COLOR	SIZE	BAG
E542 04845	Pink	21"	\$6.71
E542 04855	Pink	24"	7.31

For More Available Colors ▶ SEE PAGE 69

V-GARD® Safety Hard Hat



- Meets requirements for Type 1, ANSI Z89.1-2014 (Class E) and CSA Z94.1-2015 (Class E).
- A versatile shell design featuring strength and rigidity in a light-weight hard hat.
- Product of the USA.



Staz-On Suspension.

Ratchet Suspension.

▶ SEE PAGE 313 For All Available Colors

▶ 20 PER CASE.

ITEM NO.	PRODUCT	EACH
3085 53641	Pink	\$14.74
3085 52301	Hot Pink w/Ratchet Suspension	20.17

Hard Hat Clip

Handy clip for holding eyewear, pencils or personal items.



Hard hats and glasses sold separately.

▶ 20 PER CASE.

ITEM NO.	PRODUCT	EACH
3425 56441	Hard Hat Clip	\$2.95

Foldable Earmuffs NRR-23



▶ SEE PAGE 309 For More Details



▶ 12 PER CASE.

ITEM NO.	PRODUCT	EACH
3425 42421	Pink Foldable Earmuffs	\$9.95

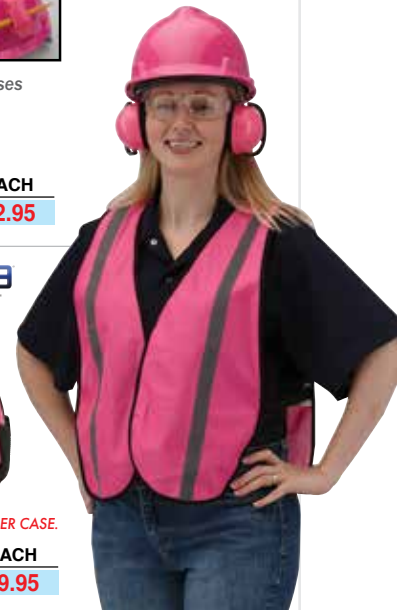



Game Season In-Stock Poly Bags

CLARITY™
E-Z PAK MEAT BAGS



For More Clarity™ E-Z Pak Poly Bags ▶ SEE PAGE 492

▶ 1,000 BAGS PER BOX - 10 BOXES PER CASE.

ITEM NO.	KEYHOLE DESIGN (NOT FOR SALE)	BOX	
		1-9	10+
3546 1075	A. 1 lb, 4.25" x 10.5", Camo Wild Game ...	\$40.95	\$38.95
3546 1399	2 lb, 4.5" x 13.5", Camo Wild Game ...	42.95	40.95
3546 5001	B. 1 lb, 4.25" x 10.5", Wild Game ...	40.95	38.95
3546 5002	2 lb, 4.25" x 13.5", Wild Game ...	42.95	40.95
3546 5005	5 lb, 6" x 18", Wild Game ...	63.95	61.95

Camo Print Locker Paper

LOCKS OUT freezer burn up to 9 months.



ITEM NO.	PRODUCT	ROLL
1090 9217	18" x 600 ft.	\$64.15

Colored, 5 Mil Zipper Vacuum Pouches

Colored vacuum pouches in affordable quantities.

- 5 mil pouch is constructed with biaxially-oriented nylon for puncture resistance and EVOH for high-barrier protection.
- Bottom fill pouches with tamper evident header, hang hole and tear notch.
- Ideal for jerky and other applications requiring extra barriers.
- 7-1/2-inch x 11-3/10-inch pouch has a zipper closure.
- Windowed on both sides for maximum viewing.

▶ 1,000 POUCHES PER CASE.

ITEM NO.	COLOR	CASE	
		1-9	10+
7264 1135	Clear	\$305.95	\$285.95
7264 5100	Yellow	329.95	309.95
7264 5101	Red	329.95	309.95
7264 5102	Black	329.95	309.95



Hang hole and zipper closure.



Virtually Indestructible LED Flashlight (3 AAA)



Drop tested from 30 feet — the aluminum titanium body is so tough it will last a lifetime.

- Shatterproof lens and reflector.
- Rubber shock absorbers help protect impact-resistant internal parts.
- Two modes: 300 lumens (20 lumens, energy saver).
- Beam: 168 meters (45 meters, energy saver).
- Battery: 3 hours (39 hours, energy saver).
- ANSI IP67 waterproof up to 1 meter, complete dust protection.
- Uses 3 AAA batteries, (included).



UP TO
300
LUMENS



For Batteries ▶ SEE PAGE 566

ITEM NO.	PRODUCT	EACH
7784 10031	LED Indestructible.	\$19.95

Virtually Indestructible LED Spotlight (6 AA)



- High performance LEDs: 670 lumens, (80 lumens, energy saver).
- Beam distance: 440 meters, (164 meters, energy saver).
- Battery run time: 8 hrs, (40 hrs, energy saver).
- 3 light modes: high, medium and low.
- 15-foot drop test performance.
- ANSI IP67 waterproof up to 1 meter, complete dust protection.
- Over-mold rubber head with wrist strap.
- Compact, impact-resistant internal engineering design, shatterproof lens and reflector.



UP TO
750
LUMENS



ITEM NO.	PRODUCT	EACH
7784 00731	LED Spotlight.	\$54.08

Wood Devil Hand Axe

The ultimate hand-axe for big game.

- Ergonomic non-slip thermo-plasticized rubber handle for a positive grip — even when wet.
- Full tang 3Cr13 stainless steel construction with black oxide protective coating.
- Two hammer surfaces: on back of head and on butt of handle. Weight: 1-1/5 pounds.
- Includes a nylon sheath. • 10 inches H x 5-1/5 inches W.



ITEM NO.	PRODUCT	EACH
3344 10021	Wood Devil Hand Axe	\$42.95

Fishing Knife

- Swedish cold-rolled stainless steel blade.
- “Easy-Clean” polypropylene sheath belt loop.
- High-friction, anti-slip rubber handle.
- Serrated blade for scaling.
- Overall length: 10-1/2 inches.
- Blade thickness: 2 mm.
- Blade length: 5-9/10 inches.
- Weight: 4.1 ounces.



Includes safety clip on sheath to hold knife securely.



ITEM NO.	PRODUCT	EACH
G965 18171	Fishing Knife	\$44.42

Curved Boning Hunting Knives

- Stainless blade with orange handle.
- Includes easy clean sheath.



► 5 PER BOX.

ITEM NO.	PRODUCT	BLADE	EACH
6818 00441	5" Curved	Flex	\$36.99

Orange Handle Axe

- Axe head constructed of black epoxy coated boron steel.
- Reinforced plastic handle.
- 12-1/2 inches H x 4-1/2 inches W.



Includes a leather sheath for axe head.

ITEM NO.	PRODUCT	EACH
5933 00051	Orange-Handled Axe	\$75.28

Kansbol Hunting Knife

- Stainless blade with orange and olive handle.
- Includes hard plastic sheath with belt loop.



► 5 PER BOX.

ITEM NO.	PRODUCT	EACH
6818 00511	Kansbol Knife	\$53.99

11-Piece GamePro Processing Kit

Great for the hunter, camper or outdoor chef.

- Precisely heat treated 420J2 stainless steel blades ensure excellent edge retention.
- Taper ground full-tang blades are durable and perfectly balanced.
- Nonslip TPR handles ensure a safe, comfortable grip after periods of long use.

Kit includes:

2-3/5-inch Caping Knife	Game Shears	Game Cleaning Gloves
4-2/5-inch Gut Hook Skinner	10-inch Wood/Bone Saw	Cutting Mat
5-1/2-inch Boning/Fillet Knife	Rib Cage Spreader	Hard Sided Carrying Case
7-1/2-inch Butcher Knife	Two Stage Sharpener	

ITEM NO.	PRODUCT	EACH
3344 00031	11-Piece GamePro Processing Kit	\$94.35





WORKHORSE®

CHECK OUT SOME OF OUR BUNZL EXCLUSIVE WORKHORSE® BRAND PRODUCTS MADE SPECIFICALLY FOR THE FOOD PROCESSING INDUSTRY.

WorkHorse® PolyPro Coated Sleeves

- Water-resistant polypropylene-coated fabric.
- Offers protection against dry particulates and light liquid sprays.
- Tapered.



▶ 200 SLEEVES PER CASE.

ITEM NO.	SIZE	COLOR	CASE
E542 0898	18"	White	\$84.74

WorkHorse® Blue Poly Shoe Covers, 3 Mil

- Constructed of heavy-duty polyethylene.
- Elastic top to keep boots clean.



▶ 50 COVERS PER BAG — 10 BAGS PER CASE.

ITEM NO.	PRODUCT	CASE
E542 15161	One Size	\$15.98

WorkHorse® Nitrile Disposable Gloves

Available in 6 colors.

- 5 mil at the palm.

Blue

Powder-Free

ITEM NO.	SIZE
E542 04115	Small
E542 04125	Medium
E542 04135	Large
E542 04145	X-Large
E542 04155	2X-Large

▶ 100 PER BOX -
10 BOXES PER CASE -
50 CASES/PALLET

BOX
\$11.95



▶ SEE PAGES 63-64
For WorkHorse®
Disposable Gloves

WorkHorse® Stainless Steel Metal Mesh Wrist-Length Gloves with Spring Closure

Durable stainless steel strap is bacteria-resistant and won't rust.

- Reversible design fits both left and right hand workers.

ITEM NO.	SIZE
E542 07161	X-Small
E542 07171	Small
E542 07181	Medium
E542 07191	Large
E542 07201	X-Large
E542 07211	2X-Large

GLOVE
\$108.05



▶ SEE PAGES 326-331
For WorkHorse®
Safety Gloves



Individually welded stainless steel links.

WorkHorse® 11 Mil Unlined, 13-Inch Straight Cuff Nitrile Gloves

- Chlorinated for ease of donning and doffing.
- Lint-free and reusable. • FDA-compliant.
- Fingertip precision with high dexterity.
- Applications: food processing — red meat, vegetables, fruit, dairy and canning, degreasing, chemical processing, oil refining, petrochemicals, manufacturing, electronics, assembly and painting.



▶ SEE PAGES 53, 58, 60
For WorkHorse®
Reusable Gloves

Blue

ITEM NO.	SIZE
E542 10055	Small, 7
E542 10065	Medium, 8
E542 10075	Large, 9
E542 10085	X-Large, 10
E542 10095	2X-Large, 11

▶ 12 DOZEN PAIR PER CASE.

DOZEN PAIR
1-11
\$17.95

Green

ITEM NO.	SIZE
E542 09955	Small, 7
E542 09965	Medium, 8
E542 09975	Large, 9
E542 09985	X-Large, 10
E542 09995	2X-Large, 11

▶ 12 DOZEN PAIR PER CASE.

DOZEN PAIR
1-11
\$17.95

WorkHorse® Tapered Disposable Earplugs

NRR-33, highest NRR available in an earplug.

- Tapered shape designed to fit most ear sizes. • Constructed of expandable foam for a comfortable seal.
- Blue cords and orange earplugs are highly visible. • Individually poly-bagged.

▶ SEE PAGES 301, 303, 305, 307-308
For WorkHorse® Earplugs



▶ 100 PAIR PER DISPENSER BOX - 10 BOXES PER CASE - 16 CASES PER PALLET.

ITEM NO.	PRODUCT	BOX
E542 09455	WorkHorse® Tapered Disposable Earplugs	\$29.95

WorkHorse® Safety Glasses with Premium Anti-Fog

- Anti-fog lenses resist fogging while wearing a facemask, or in cold or humid environments.
- After multiple washings, premium anti-fog coating retains effectiveness for the lifetime of the glasses.
- Meets ANSI Z87.1+, CE EN166 and CSA Z94.3. • 99.9% UV Protection.
- Scratch-resistant coating. • Metal-detectable hinge pins.

For WorkHorse® Safety Glasses ▶ SEE PAGES 290, 292, 294



▶ 12 PER BOX - 25 BOXES PER CASE - 144 CASES PER PALLET.

ITEM NO.	PRODUCT	EACH
E542 09241	WorkHorse® Frameless Clear, Premium Anti-Fog	\$4.95
E542 09631	WorkHorse® Frameless Blue, Premium Anti-Fog	4.95

WorkHorse® N95 Molded Respirators*

Available with or without a valve.

- Economical, particulate respirator N95 approved.
- Dual-welded, blue head straps eliminate staples and are visually detectable.
- Shell resists collapsing in heat and humidity.
- Facepiece is naturally contoured without pressure points.

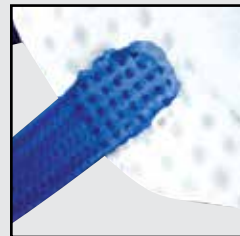

Head strap is heat sealed to mask — no staples that can fall into food.



*Not for medical use.

▶ 12 PER BOX - 20 BOXES PER CASE - 18 CASES PER PALLET.

ITEM NO.	PRODUCT	BOX
E542 09315	WorkHorse® N95 Molded w/Valve	\$20.95

▶ 20 PER BOX - 20 BOXES PER CASE - 18 CASES PER PALLET.

ITEM NO.	PRODUCT	BOX
E542 09305	WorkHorse® N95 Molded w/o Valve	\$18.95



WorkHorse® Honeycomb White Nylon Weave Hairnets

▶ 100 PER BAG - 10 BAGS PER CASE.

ITEM NO.	SIZE	BAG
E542 04775	18"	\$7.24
E542 04785	21"	8.31
E542 04795	24"	8.96

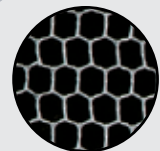

▶ SEE PAGES 69-71
For WorkHorse® Hairnets,
Bouffants and Beard Guards

BOOT CHEMICAL RESILIENCY COMPARISON CHART

Use this chart to help you determine what boot is right for you, based on your everyday applications.



LIQUID/CHEMICAL TYPE	RUBBER	NEOPRENE	POLY/PVC/NITRILE	URETHANE/PVC	POLYURETHANE
Acetic Acid	FAIR	GOOD	GOOD	POOR	–
Acetone	POOR	FAIR	POOR	POOR	–
Ammonium Hydroxide	GOOD	EXCELLENT	EXCELLENT	GOOD	EXCELLENT
Animal Fats	POOR	EXCELLENT	FAIR	FAIR	EXCELLENT
Benzene	POOR	POOR	POOR	POOR	POOR
Bleach	POOR	GOOD	GOOD	GOOD	EXCELLENT
Butter	POOR	EXCELLENT	GOOD	GOOD	GOOD
Buttermilk	POOR	EXCELLENT	GOOD	GOOD	GOOD
Castor Oil	EXCELLENT	GOOD	EXCELLENT	EXCELLENT	EXCELLENT
Chlorine Water	FAIR	FAIR	GOOD	GOOD	FAIR
Citric Acid	EXCELLENT	EXCELLENT	EXCELLENT	EXCELLENT	EXCELLENT
Coconut Oil	POOR	GOOD	FAIR	FAIR	EXCELLENT
Cottonseed Oil	POOR	GOOD	GOOD	GOOD	GOOD
Ethyl Alcohol	EXCELLENT	GOOD	EXCELLENT	GOOD	–
Formaldehyde	GOOD	GOOD	EXCELLENT	GOOD	–
Gasoline	POOR	POOR	GOOD	GOOD	GOOD
Grease	POOR	GOOD	EXCELLENT	EXCELLENT	EXCELLENT
Hydraulic Oil	POOR	POOR	EXCELLENT	EXCELLENT	GOOD
Hydrochloric Acid	POOR	POOR	EXCELLENT	POOR	–
Lactic Acid	EXCELLENT	EXCELLENT	EXCELLENT	EXCELLENT	FAIR
Lard Oil	POOR	GOOD	GOOD	GOOD	GOOD
Linseed Oil	POOR	EXCELLENT	FAIR	FAIR	–
MEK	FAIR	GOOD	POOR	POOR	FAIR
Methyl Acetate	POOR	FAIR	POOR	POOR	–
Methylene Chloride	POOR	POOR	POOR	POOR	–
Milk	GOOD	EXCELLENT	EXCELLENT	EXCELLENT	EXCELLENT
Mineral Oil	POOR	EXCELLENT	GOOD	GOOD	EXCELLENT
Naphtha	POOR	POOR	FAIR	GOOD	GOOD
Nitric Acid Concentrate	POOR	POOR	GOOD	POOR	–
Olive Oil	POOR	GOOD	GOOD	GOOD	EXCELLENT
Perchloroethylene	POOR	POOR	FAIR	POOR	–
Soaps	GOOD	EXCELLENT	EXCELLENT	EXCELLENT	EXCELLENT
Sodium Hydroxide	EXCELLENT	EXCELLENT	EXCELLENT	EXCELLENT	–
Sulfuric Acid, 50%	GOOD	EXCELLENT	EXCELLENT	POOR	–
Toluene	POOR	POOR	POOR	POOR	GOOD
Trichlorethylene	POOR	POOR	FAIR	POOR	–
Vegetable Oil	POOR	EXCELLENT	FAIR	FAIR	EXCELLENT



WARNING:

Some products in this catalog may expose you to chemicals including DEHP Di (2-ethylhexyl) phthalate or BPA (Bisphenol A) which are known to the State of California to cause cancer or birth defects or other reproductive harm. For more information, visit www.P65Warnings.ca.gov.



CLOTHING

FIND IT FAST

Boot Comparison Chart.	12
Boots	14-22
Work Shoes.	23
Insoles, Socks and Boot Liners.	24-25
Boot Racks.	25-26
Boot Wash Stations	27
Overshoes	29
Shoe and Boot Covers.	30-31
Insulated Clothing.	32-38
Insulated Gloves.	39, 46
Gloves	39-67
Thermal Hand Protection	42-45
Disposable Gloves	62-67
Glove and Apron Dispensers	68
Bouffant Caps, Hairnets and Beard Guards	69-71
Sleeves.	66-67
Aprons and Gowns	73-81, 84
Disposable Clothing.	82-83
Work Clothes	82-83
Laundry Supplies	85
Frocks.	86-87
Rainwear and Acid Suits	88-93



PURFORT® FoodPro Steel Toe Boots

35% lighter than traditional rubber and PVC boots!

- Resistant to mineral, animal and vegetable oil, fats, blood, disinfectants and various chemicals.
- Highest slip resistant sole of any boot. Certified slip resistance (EN ISO 20345:2011 S4 CI SRC).
- Complies with CSA Z195-14 Omega, ASTM F2413-18 M/IC EH. • Steel toe cap for added safety.
- Remains flexible at low temperatures. • Shock-absorbing heel. • Sole designed for specific food processing areas.
- Five colors to reduce cross-contamination. • Seamed anti-bacterial lining. • 14-inch upper.
- Thermal insulation keeps feet warm in temperatures as low as -4 °F and comfortable in hot conditions.
- Extra smooth upper for easy cleaning. • Orthopaedic insole design for superior comfort.
- Energy absorbing heel for extra ergonomic support.

NOTE: Our boots can be ordered and worn by men or women. There is a two size difference between men's and women's sizes. A woman ordering a boot should order two sizes smaller than her regular size. Example: women's size 9 would order men's size 7.



A. White

ITEM NO.	MEN'S SIZE
E014 00391	Size 3
E014 00401	Size 4
E014 00411	Size 5
E014 00421	Size 6
E014 00431	Size 7
E014 00441	Size 8
E014 00451	Size 9
E014 00461	Size 10
E014 00471	Size 11
E014 00481	Size 12
E014 00491	Size 13
E014 00501	Size 14
E014 00511	Size 15

B. Blue

ITEM NO.	MEN'S SIZE
E014 16041	Size 4
E014 16051	Size 5
E014 16061	Size 6
E014 16071	Size 7
E014 16081	Size 8
E014 16091	Size 9
E014 16101	Size 10
E014 16111	Size 11
E014 16121	Size 12
E014 16131	Size 13
E014 16141	Size 14
E014 16151	Size 15

C. Yellow

ITEM NO.	MEN'S SIZE
E014 07001	Size 4
E014 07011	Size 5
E014 07021	Size 6
E014 07031	Size 7
E014 07041	Size 8
E014 07051	Size 9
E014 07061	Size 10
E014 07071	Size 11
E014 07081	Size 12
E014 07091	Size 13
E014 07101	Size 14
E014 07111	Size 15

F.O.B. FACTORY
 ▶ 6 PAIR PER CASE.

PAIR
\$141.62

PUROFORT® is the unique Dunlop® material with millions of evenly distributed air pockets making it light-weight and thermally insulating plus a cross-linked structure that provides flexibility and strength. The material is created using a special recipe at the time of manufacture, giving your Purofort® boots a "born on" date. This gives Purofort® boots their remarkable properties.

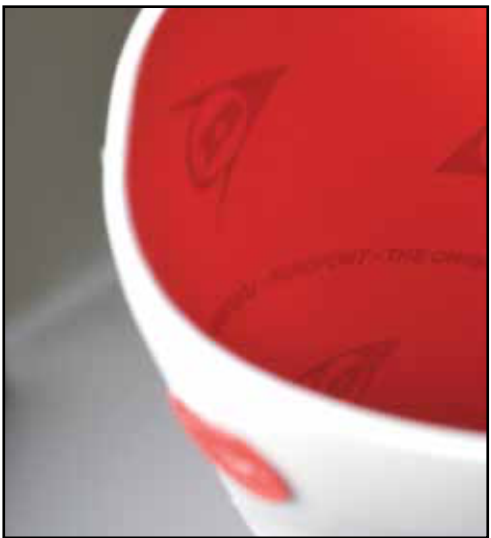
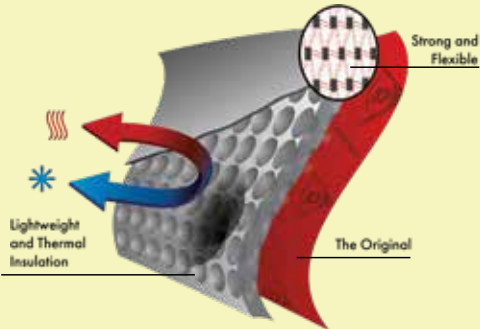

**Brown Boot
Only Available
at BPD!**



Unique feature allows boots to be locked together. (separate lock required)



Scan this QR code with your mobile device to learn more about Purofort® Boots.

D



E



Purofort durability and slip-resistant sole outperforms traditional neoprene boots.

Multigrip Safety Sole: SRC rated for best slip resistance.

D. Brown

ITEM NO.	MEN'S SIZE
E014 01371	Size 3
E014 00801	Size 4
E014 00811	Size 5
E014 00821	Size 6
E014 00831	Size 7
E014 00841	Size 8
E014 00851	Size 9
E014 00861	Size 10
E014 00871	Size 11
E014 00881	Size 12
E014 00891	Size 13
E014 00901	Size 14
E014 00911	Size 15

E. Green

ITEM NO.	MEN'S SIZE
E014 18341	Size 4
E014 18351	Size 5
E014 18361	Size 6
E014 18371	Size 7
E014 18381	Size 8
E014 18391	Size 9
E014 18401	Size 10
E014 18411	Size 11
E014 18421	Size 12
E014 18431	Size 13
E014 18441	Size 14
E014 18451	Size 15

F.O.B. FACTORY
► 6 PAIR PER CASE.

PAIR
\$141.62

Chesapeake® Boots

Light and mighty with outsole that channels to repel water.

- Steel toe complies with ASTM F2413-11 standard.
- 25% lighter than classic PVC boots.
- 100% waterproof.
- 14-inch upper.
- Color: black.

Pull tab for easy donning and doffing.



Energy absorbing BAY-LOC outsole with channels to repel water.



Plain Toe

ITEM NO.	MEN'S SIZE
E014 00921	Size 3
E014 00931	Size 4
E014 00941	Size 5
E014 00951	Size 6
E014 00961	Size 7
E014 00971	Size 8
E014 00981	Size 9
E014 00991	Size 10
E014 01001	Size 11
E014 01011	Size 12
E014 01171	Size 13
E014 01181	Size 14
E014 01191	Size 15

▶ 6 PAIR PER CASE.

PAIR
\$29.30

Steel Toe

ITEM NO.	MEN'S SIZE
E014 01201	Size 3
E014 01211	Size 4
E014 01221	Size 5
E014 01231	Size 6
E014 01241	Size 7
E014 01251	Size 8
E014 01261	Size 9
E014 01271	Size 10
E014 01281	Size 11
E014 01291	Size 12
E014 01301	Size 13
E014 01311	Size 14
E014 01321	Size 15

▶ 6 PAIR PER CASE.

PAIR
\$33.83

White, Steel Toe PVC Boots

PVC upper provides mild chemical resistance and helps comply with HACCP guidelines.

- 16-inch upper with cut-off bands for height adjustment.
- Built in steel shank for all day comfort.
- Pull-up and kick-off lugs.
- Steel toe meets ASTM F2413-11.
- Color: white.

Slip-resistant safety-loc outsole for superior traction on slippery surfaces.



NOTE: Our boots can be ordered and worn by men or women. There is a two size difference between men's and women's sizes. A woman ordering a boot should order two sizes smaller than her regular size. Example: women's size 9 would order men's size 7.



ITEM NO.	MEN'S SIZE
3161 51541	Size 4
3161 51551	Size 5
3161 51561	Size 6
3161 51571	Size 7
3161 51581	Size 8
3161 51591	Size 9
3161 51601	Size 10
3161 51611	Size 11
3161 51621	Size 12
3161 51631	Size 13

▶ 6 PAIR PER CASE.

PAIR
\$47.05

DuraPro® Boots

- Larger circumference at the top makes it quick and easy to pull the boot on.
- Inner liner allows for increased flexibility and subtle feel at the calf.
- Conformance information molded in sidewall for easy identification.
- Wider metatarsal design and comfort ankle for all-day comfort.
- Honeycomb design molded inside the heel to reduce impact when walking.
- Ergonomically designed foot bed to provide better underfoot support.



DuraPro® energizing insoles provide superior shock absorption, support and comfort. The comfort rim makes it feel more like a shoe than a boot.



Brown Steel Toe DuraPro® XCP Superpoly Upper

For use in the red meat and slaughter industry with a superior resistance to fats and oils.

Chevron sole has canals for easy decontamination and slip resistance.

ITEM NO.	MEN'S SIZE
3161 46531	Size 3
3161 46541	Size 4
3161 46551	Size 5
3161 46561	Size 6
3161 46571	Size 7
3161 46581	Size 8
3161 46591	Size 9
3161 46601	Size 10
3161 46611	Size 11
3161 46621	Size 12
3161 46631	Size 13
3161 46641	Size 14
3161 46651	Size 15
3161 46661	Size 16

▶ 6 PAIR PER CASE.

PAIR
\$86.27



Blue DuraPro® Polyblend Upper

For use in the poultry and pork industry where moderate chemical resistance is required.

Safety-loc sole designed for superior traction with canals for easy decontamination.

Plain Toe

ITEM NO.	MEN'S SIZE
3161 48531	Size 3
3161 48541	Size 4
3161 48551	Size 5
3161 48561	Size 6
3161 48571	Size 7
3161 48581	Size 8
3161 48591	Size 9
3161 48601	Size 10
3161 48611	Size 11
3161 48621	Size 12
3161 48631	Size 13
3161 48641	Size 14
3161 48651	Size 15
3161 48661	Size 16

▶ 6 PAIR PER CASE.

PAIR
\$59.00

Steel Toe

ITEM NO.	MEN'S SIZE
3161 49531	Size 3
3161 49541	Size 4
3161 49551	Size 5
3161 49561	Size 6
3161 49571	Size 7
3161 49581	Size 8
3161 49591	Size 9
3161 49601	Size 10
3161 49611	Size 11
3161 49621	Size 12
3161 49631	Size 13
3161 49641	Size 14
3161 49651	Size 15
3161 49661	Size 16

▶ 6 PAIR PER CASE.

PAIR
\$62.35

PolyGoliath Boot

Highly abrasion-resistant and 100% waterproof.

- Special urethane/PVC compound is resistant to acids, oils, greases, chemicals and animal fats.
- Outsole provides excellent traction both indoors and outdoors.
- Two stage, injection-molded, one-piece construction is highly abrasion-resistant and 100% waterproof.

Power lug outsole with multi-tread design provides comfort and slip-resistance.



- Lower toe spring for a more comfortable fit and better surface contact.
- Cut-off bands to shorten boots if desired.
- Kick-off lugs for easy removal.
- One-piece steel shank.
- 16-inch upper.



Plain Toe

ITEM NO.	MEN'S SIZE
3161 88051	Size 5
3161 88061	Size 6
3161 88071	Size 7
3161 88081	Size 8
3161 88091	Size 9
3161 88101	Size 10
3161 88111	Size 11
3161 88121	Size 12
3161 88131	Size 13
3161 88141	Size 14
3161 88151	Size 15

▶ 6 PAIR PER CASE.

PAIR
\$47.91

Steel Toe

ITEM NO.	MEN'S SIZE
3161 72051	Size 5
3161 72061	Size 6
3161 72071	Size 7
3161 72081	Size 8
3161 72091	Size 9
3161 72101	Size 10
3161 72111	Size 11
3161 72121	Size 12
3161 72131	Size 13
3161 72141	Size 14
3161 72151	Size 15

▶ 6 PAIR PER CASE.

PAIR
\$52.76

Cleated outsole for excellent traction in wet or muddy terrain, with exceptional puncture resistance.



Economy Steel Toe and Midsole Boots

Steel toe and steel midsole provides exceptional protection for any application.

- Steel toe is CSA certified, ASTM F2413-11 compliant with steel midsole.
- Injected molded seamless construction provides waterproof protection that is easy to clean.



ITEM NO.	MEN'S SIZE
3161 69261	Size 6
3161 69271	Size 7
3161 69281	Size 8
3161 69291	Size 9
3161 69301	Size 10
3161 69311	Size 11
3161 69321	Size 12
3161 69331	Size 13

▶ 6 PAIR PER CASE.

PAIR
\$56.79

PolyFlex 3 Boots

Polyblend® compound and a sleek design gives you chemical protection and all-day comfort.

- Polyblend compound offers superior resistance to fats, oils and chemicals.
- Power Lug outsole powered by a multi tread design provides exceptional comfort and slip resistance for indoor traction.
- Steel toe complies with ASTM F2413-11 with steel shank. • Used in protein processing, poultry, dairy, fruits and vegetables.



Power lug outsole with multi-tread design provides comfort and slip-resistance.



Plain Toe

ITEM NO.	MEN'S SIZE
3161 64051	Size 5
3161 64061	Size 6
3161 64071	Size 7
3161 64081	Size 8
3161 64091	Size 9
3161 64101	Size 10
3161 64111	Size 11
3161 64121	Size 12
3161 64131	Size 13
3161 64141	Size 14
3161 64151	Size 15

Steel Toe

ITEM NO.	MEN'S SIZE
3161 68051	Size 5
3161 68061	Size 6
3161 68071	Size 7
3161 68081	Size 8
3161 68091	Size 9
3161 68101	Size 10
3161 68111	Size 11
3161 68121	Size 12
3161 68131	Size 13
3161 68141	Size 14
3161 68151	Size 15

▶ 6 PAIR PER CASE.

PAIR
\$66.52

▶ 6 PAIR PER CASE.

PAIR
\$71.81



PolySteel Steel Toe and Midsole Boots

Polyblend® compound and CSA-certified steel toe and midsole, protection from all angles.

- Polyblend compound upper offers a third layer of protection for moderate chemical resistance.
- Steel toe is CSA certified, ASTM F2413-11 compliant with steel midsole.

Steel midsole Ultragrip® Sipe outsole provides superior, slip resistance and puncture protection.



ITEM NO.	MEN'S SIZE
3161 69061	Size 6
3161 69071	Size 7
3161 69081	Size 8
3161 69091	Size 9
3161 69101	Size 10
3161 69111	Size 11
3161 69121	Size 12
3161 69131	Size 13
3161 69141	Size 14
3161 69151	Size 15

▶ 6 PAIR PER CASE.

PAIR
\$105.60

Expandable gusset



V-wave pattern offer the best traction for areas with heavy debris.



Neoprene Dipped, Waterproof Boots with Gusset

- Removable Breatheaprene® insoles provide shock absorption and moisture wicking.
- Gusset provides calf flexibility. • Meets ASTM F2413-18 M/I/C EH.
- Fabric-lined for easy on and off.



SERVUS

12 Inch

Steel Toe

ITEM NO.	MEN'S SIZE
3330 32331	Size 3
3330 32341	Size 4
3330 32351	Size 5
3330 32361	Size 6
3330 32371	Size 7
3330 32381	Size 8
3330 32391	Size 9
3330 32401	Size 10
3330 32411	Size 11
3330 32421	Size 12
3330 32431	Size 13
3330 32441	Size 14
3330 32451	Size 15

► 6 PAIR PER CASE.

PAIR

\$121.75

Neoprene Dipped, Waterproof, Insulated Boots

- Insulated boot has built-in foam insulation to keep feet warm and dry in low temperatures.
- Breathe-O-Prene® insole pulls moisture away from feet for all day comfort.
- Meets ASTM F2412-11 M I/75 C/75 and ASTM F1671/ F1671M - 13.



XTRATUF



Open channel, slip-resistant, non-marking sole.



12 Inch

Steel Toe

ITEM NO.	MEN'S SIZE
3330 22261	Size 4
3330 22271	Size 5
3330 22281	Size 6
3330 22291	Size 7
3330 22301	Size 8
3330 22311	Size 9
3330 22321	Size 10
3330 22331	Size 11
3330 22341	Size 12
3330 22351	Size 13
3330 22361	Size 14
3330 22371	Size 15

► 6 PAIR PER CASE.

PAIR

\$142.89



Neoprene Dipped, Waterproof Boots

Triple-dipped protection against harsh chemicals.

- Removable Breatheaprene® insoles provide shock absorption and moisture wicking.
- Steel toed boots meet ASTM F2413-18 M/IC EH and ASTM F1671/F1671M-13.
- Plain toed boots meet ASTM F2892-18 M EH and ASTM F1671/F1671-13.
- Fabric-lined for easy on and off.



Open channels squeegee liquids, fats and debris out with each step.

A. 12 Inch

Plain Toe

ITEM NO.	MEN'S SIZE
3330 34041	Size 4
3330 34051	Size 5
3330 34061	Size 6
3330 34071	Size 7
3330 34081	Size 8
3330 34091	Size 9
3330 34101	Size 10
3330 34111	Size 11
3330 34121	Size 12
3330 34131	Size 13
3330 56441	Size 14

▶ 6 PAIR PER CASE.

PAIR
\$106.85

B. 12 Inch

Steel Toe

ITEM NO.	MEN'S SIZE
3330 22441	Size 4
3330 22451	Size 5
3330 22461	Size 6
3330 22471	Size 7
3330 22481	Size 8
3330 22491	Size 9
3330 22501	Size 10
3330 22511	Size 11
3330 22521	Size 12
3330 22531	Size 13
3330 56431	Size 14
3330 56451	Size 15

▶ 6 PAIR PER CASE.

PAIR
\$113.75

C. 15 Inch

Steel Toe

ITEM NO.	MEN'S SIZE
3330 55631	Size 3
3330 55641	Size 4
3330 79451	Size 5
3330 79461	Size 6
3330 79471	Size 7
3330 79481	Size 8
3330 79491	Size 9
3330 79501	Size 10
3330 79511	Size 11
3330 79521	Size 12
3330 79531	Size 13
3330 56421	Size 14
3330 79551	Size 15

▶ 6 PAIR PER CASE.

PAIR
\$116.95

NOTE: Our boots can be ordered and worn by men or women. There is a two size difference between men's and women's sizes. A woman ordering a boot should order two sizes smaller than her regular size. Example: women's size 9 would order men's size 7.



PUOFORT® RigPRO Steel Toe Boots

Snug-fit construction, fits like a sneaker.

- 100% waterproof, cut and abrasion-resistant.
- Cold insulation down to -4 °F while still comfortable in warm conditions.
- SRC-rated outsole for anti-slip protection.
- Features mid-calf rigger height.
- Tread wear indicators warn when its time for replacement.
- Safety standard: ASTM F2413-18 M/I/C PR – SRC.

ITEM NO.	MEN'S SIZE
E014 02571	Size 5
E014 02581	Size 6
E014 02591	Size 7
E014 02601	Size 8
E014 02611	Size 9
E014 02621	Size 10
E014 02631	Size 11
E014 02641	Size 12
E014 02651	Size 13
E014 02661	Size 14

▶ 6 PAIR PER CASE.

PAIR
\$92.24

NOTE: Our boots can be ordered and worn by men or women. There is a two size difference between men's and women's sizes. A woman ordering a boot should order two sizes smaller than her regular size. Example: women's size 9 would order men's size 7.



Acifort® MetMAX Boots

Provides maximum protection for high-risk environments.

- Reinforced PVC for improved chemical resistance, flexibility and product lifespan.
- Full safety footwear with certified metatarsal and ankle protection.
- Snugfit and comfort insole for superior comfort and support.
- SRC-rated outsole for anti-slip protection. • Dual-density midlayer absorbs impact.
- Tread wear indicators warn when its time for replacement.
- Safety standard: ASTM F2413-18 M/I/C PR EH Mt and ASTM 3445-21 SR.

ACIFORT® is Dunlop's unique invention of PVC, nitrile rubber and polymers. Nitrile rubber ensures a longer lifetime and better resistance to oil, fat, blood and chemicals. Polymers add flexibility to your boot, thereby increasing comfort.

ITEM NO.	MEN'S SIZE
E014 02341	Size 4
E014 02351	Size 5
E014 02361	Size 6
E014 02371	Size 7
E014 02261	Size 8
E014 02271	Size 9
E014 02281	Size 10
E014 02291	Size 11
E014 02301	Size 12
E014 02311	Size 13
E014 02321	Size 14
E014 02331	Size 15

▶ 6 PAIR PER CASE.

PAIR
\$62.24

Waterproof Polyblend Steel Toe Work Shoes

- One-piece injection molded poly/PVC blend provides moderate resistance to chemicals and full water-resistance.
- Built-in steel shank supports lower leg for all day comfort.
- Non-slip, self-cleaning cleated sole.
- 6-inch upper.
- Kick-off lugs.
- Steel toe complies with ASTM F2413-11.



Cleated outsole to prevent clogging on wet or muddy surfaces.

ITEM NO.	MEN'S SIZE
3161 51961	Size 6
3161 51971	Size 7
3161 51981	Size 8
3161 51991	Size 9
3161 52001	Size 10
3161 52011	Size 11
3161 52021	Size 12
3161 52031	Size 13

▶ 6 PAIR PER CASE.

PAIR

\$56.19

Oliver Boots 45680C

Composite toe boots offer high-impact protection and is 40% lighter than traditional steel toe caps for less fatigue when worn all day. Meets ASTM F2413-11 M I/75 C/75 Mt/75 EH.

- 8 inch, lace-up, insulated, liquid-resistant, black leather.
- NATUREform composite toe impact protection.
- PORON XRD metatarsal guard.
- SYMPATEX waterproof liner to help keep feet dry.
- 600-gram Thinsulate ULTRA liner for sub-zero environments.
- NANOLite and COMFORTcushion technology help reduce leg fatigue and enhance comfort.
- All-terrain, TPU soling technology consists of a light-weight, shock absorbing low-density PU (polyurethane) midsole cushions the foot with each step.
- Outsole design is slip-resistant to help prevent worker slips and falls and is heat-resistant to temperatures up to 266 °F (130 °C).



by Honeywell

8-inch lace-up design.



Composite toe.

ITEM NO.	MEN'S SIZE
3330 01291	Size 7
3330 01321	Size 8
3330 01341	Size 9
3330 01471	Size 10
3330 01491	Size 11
3330 01511	Size 12
3330 01521	Size 13

▶ 6 PAIR PER CASE.

PAIR

\$262.10

Premium Insoles

- Support of the foot, with extra energy absorption at the heel to reduce fatigue.
- 30% more odor control.



ITEM NO.	MEN'S SIZE
E014 00261	Size 4
E014 00271	Size 5
E014 00281	Size 6
E014 00291	Size 7
E014 00301	Size 8
E014 00311	Size 9
E014 00321	Size 10
E014 00331	Size 11
E014 00341	Size 12
E014 00351	Size 13
E014 00361	Size 14
E014 00371	Size 15
E014 00381	Size 16/17

ITEM NO.	MEN'S SIZE
E014 00261	Size 4
E014 00271	Size 5
E014 00281	Size 6
E014 00291	Size 7
E014 00301	Size 8
E014 00311	Size 9
E014 00321	Size 10
E014 00331	Size 11
E014 00341	Size 12
E014 00351	Size 13
E014 00361	Size 14
E014 00371	Size 15
E014 00381	Size 16/17

▶ 10 PAIR PER CASE.

PAIR
\$26.83

DuraPro® Insoles

Prolong the life of your footwear while improving on comfort

- A deep heel cup and arch support realign your feet to a natural position.
- Shock-absorbing pads in the heel and forefoot.
- Works best when worn in shoes with removable insoles, but can also be worn in most flat shoes.



▶ 10 PAIR PER CASE.

PAIR
\$17.79

Standard Preformed Insoles

- Provides additional comfort and cushion protection.
- Built-in arch support.

ITEM NO.	MEN'S SIZE
3161 10831	Size 3
3161 10841	Size 4
3161 10851	Size 5
3161 10861	Size 6
3161 10871	Size 7
3161 10881	Size 8
3161 10891	Size 9
3161 10901	Size 10
3161 10911	Size 11
3161 10921	Size 12
3161 10931	Size 13
3161 10941	Size 14
3161 10951	Size 15

ITEM NO.	MEN'S SIZE
3161 10831	Size 3
3161 10841	Size 4
3161 10851	Size 5
3161 10861	Size 6
3161 10871	Size 7
3161 10881	Size 8
3161 10891	Size 9
3161 10901	Size 10
3161 10911	Size 11
3161 10921	Size 12
3161 10931	Size 13
3161 10941	Size 14
3161 10951	Size 15

▶ 10 PAIR PER CASE.

PAIR
\$10.85



Economy Comfort Insoles

The most comfortable insole you'll ever buy.

- Multi-Durometer polyurethane rubber.
- Fits any brand or style rubber boots.
- Improves worker productivity.
- Unique arch support.
- Doubles your boot life.
- Reduces back pain.
- Heel support is nearly 3/8 inch thick.



▶ 6 PAIR PER CASE.

PAIR
\$10.62

ITEM NO.	MEN'S SIZE
E651 00561	Size 5 - 6.5
E651 00781	Size 7 - 8.5
E651 09101	Size 9 - 10.5
E651 11121	Size 11 - 12.5
E651 13151	Size 13 - 15

ITEM NO.	MEN'S SIZE
E651 00561	Size 5 - 6.5
E651 00781	Size 7 - 8.5
E651 09101	Size 9 - 10.5
E651 11121	Size 11 - 12.5
E651 13151	Size 13 - 15

ITEM NO.	WOMEN'S SIZE
E651 00561	Size 7 - 8.5
E651 00781	Size 9 - 10.5
E651 09101	Size 11 - 12.5
E651 11121	Size 13 - 15

ITEM NO.	WOMEN'S SIZE
E651 00561	Size 7 - 8.5
E651 00781	Size 9 - 10.5
E651 09101	Size 11 - 12.5
E651 11121	Size 13 - 15

Frelonic Comfort Insoles

- Rubber cushion pads at heel and ball of foot offer slip-resistance and longer life.
- All-day cushioned comfort.
- Machine washable.



▶ 6 PAIR PER CASE.

PAIR
\$8.55

ITEM NO.	MEN'S SIZE
3372 31371	Size 7
3372 31381	Size 8
3372 31391	Size 9
3372 31401	Size 10
3372 31411	Size 11
3372 31421	Size 12
3372 31431	Size 13

ITEM NO.	MEN'S SIZE	ITEM NO.	WOMEN'S SIZE
3372 31371	Size 7	3372 31451	Size 5
3372 31381	Size 8	3372 31461	Size 6
3372 31391	Size 9	3372 31471	Size 7
3372 31401	Size 10	3372 31481	Size 8
3372 31411	Size 11	3372 31491	Size 9
3372 31421	Size 12	3372 31501	Size 10

Sorbothane® Shock-Absorbing Insoles

- Reduces lower back fatigue and pain.
- Resistant to odor-causing bacteria.
- Machine washable.



▶ 6 PAIR PER CASE.

PAIR
\$18.95

ITEM NO.	MEN'S SIZE
F203 95181	Size 5 - 6
F203 95191	Size 6.5 - 7.5
F203 95201	Size 8 - 9
F203 95211	Size 9.5 - 10.5
F203 95221	Size 11 - 12
F203 95231	Size 12.5 - 13.5

ITEM NO.	MEN'S SIZE
F203 95181	Size 5 - 6
F203 95191	Size 6.5 - 7.5
F203 95201	Size 8 - 9
F203 95211	Size 9.5 - 10.5
F203 95221	Size 11 - 12
F203 95231	Size 12.5 - 13.5

ITEM NO.	WOMEN'S SIZE
F203 95161	Size 4.5 - 5.5
F203 95171	Size 6 - 7
F203 95181	Size 7.5 - 8.5
F203 95191	Size 9 - 10
F203 95201	Size 10.5 - 11.5
F203 95211	Size 12

ITEM NO.	WOMEN'S SIZE
F203 95161	Size 4.5 - 5.5
F203 95171	Size 6 - 7
F203 95181	Size 7.5 - 8.5
F203 95191	Size 9 - 10
F203 95201	Size 10.5 - 11.5
F203 95211	Size 12

Insulated Boot Liners



- Boot liner fits most knee boots.
- Machine washable.
- Wear one size larger boot when wearing these liners.



ITEM NO.	MEN'S SIZE
E014 00631	X-Small, Size 4 - 5
E014 00641	Small, Size 6 - 7
E014 00651	Medium, Size 8 - 9
E014 00661	Large, Size 10 - 11
E014 00671	X-Large, Sizes 12 - 13

PAIR
\$20.06

Rack 'Em™ Boot Rack



- Increases boot life by holding shape.
- Dries boots by elevating and allowing for greater air circulation.
- Black PVC coated heavy-duty galvanized steel construction resists rust.
- Screws supplied for easy mounting and are 16 inches on center.
- Holds four pairs. • 9 inches wide.



ITEM NO.	PRODUCT	EACH
3446 10441	Boot Rack	\$60.95

A. Heavyweight Thermal Boot Socks

- 85% wool, 12% nylon and 3% spandex.
- Fits men's shoe sizes 8-11. • Machine washable.

B. Mid-Weight Socks

- 50% wool, 25% acrylic, 20% nylon and 5% other fibers.
- Fits men's shoe sizes 8-11. • Machine washable.

C. Insulated Socks

- Made of 80% acrylic, 10% nylon, 10% cotton.
- Machine washable.



ITEM NO.	PRODUCT	PAIR
1056 0168	A. Heavyweight Socks	\$14.65
1056 0169	B. Mid-Weight Socks	7.95
0158 0429	C. Small/Medium Wick Socks	13.72
0158 0430	Large/X-Large, Wick Socks	13.72

Rack 'Em™ Boot Stand



- Helps dry, organize and store boots so they last longer.
- Heavy-duty steel construction holds all sizes and styles.
- Holds two pair.
- Works great for gloves too.



ITEM NO.	PRODUCT
3446 11321	Boot Stand

F.O.B. FACTORY
EACH
\$58.63

▶ SEE PAGES 61, 68, 73, 300 & 314

TO FIND MORE
RACK'EM PRODUCTS

New Age Industrial Aluminum Mobile Boot Drying Racks

- Constructed from 100% aluminum tubing. • Fully washdown and corrosion resistant.
- 5-inch casters — 2 swivel with breaks and 2 rigid. • Fully assembled.
- Available in 6, 12 (not pictured) or 25-pair models.



ITEM NO.	PRODUCT	MFR. NO.	DIMENSIONS	F.O.B. FACTORY EACH
3775 0063	A. 6-Pair Boot Drying Rack	52783.	22-1/2" x 26" x 32-1/2"	\$1,088.78
3775 0065	B. 25-Pair Boot Drying Rack	52782.	50-1/4" x 24" x 59"	1,576.06
3775 0064	12-Pair Boot Drying Rack (Not Pictured)	52869.	50-1/2" x 26" x 34-1/8"	1,509.07

NOTE: Boots sold separately.

Stainless Steel Mobile Boot Drying Rack

- 100% 1-inch square T-304 stainless steel tubing.
- Fully washdown and corrosion resistant.
- 4-inch stainless steel/white polyolefin casters — 2 swivel and 2 rigid.
- Fully assembled.
- Holds 24 pairs of boots.
- Shipping weight: 175 pounds.



ITEM NO.	DIMENSIONS	F.O.B. FACTORY EACH
2990 1108	48" x 25-1/2" x 79-3/4"	\$2,484.25

Boot n' Shoe Brush

Helps eliminate bacteria, refuse, dirt and other contaminants from being tracked into food processing areas.

- Constructed of a tough 10-inch plastic block and 1-3/4-inch bristles.
- Chrome steel tube frame can be securely bolted to the floor for security and convenience.
- Brushes flip up to expose a steel scraper for removing heavy debris.



ITEM NO.	PRODUCT
6387 24001	Boot n' Shoe Brush

EACH
\$85.94



Cleans bottom and sides of boots. Brushes flip open to expose scraper bar.



Scraper bar for cleaning debris on soles.



High-Wall Disinfectant Boot Dip Mat

2 inch wall height guarantees solution will cover sole, sides and welt/arch area of boot.

- Use wherever cross-contamination is a concern.
- Holds up to 22 quarts of solution.

ITEM NO.	PRODUCT	DIMENSIONS	EACH
4480 3239	Boot Dip Mat	32" x 39" x 2"	\$115.45

TOTAL SOLUTIONS® Vanquish "One Step"

Disinfectant — Sanitizer — Cleaner — Fungicide — Deodorizer

- Mixed with water, one-gallon bottle makes 64 gallons to fill mats over 11 times!
- Meets EPA and USDA guidelines for D-2 Rated sanitizers.

▶ 4 PER CASE.

ITEM NO.	PRODUCT	EACH
2117 01751	1 Gallon	\$33.54
2117 0176	55 Gallon	1,104.93



We recommend use with Total Solutions "One-Step" Vanquish Sanitizer.

For Detailed Product Information ▶ SEE PAGE 145

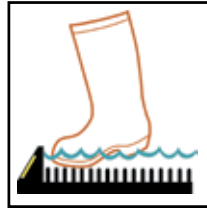

Solution covers sole, sides and arch area of boot.



Mat grip pattern provides non-slip surface.



TECHNOLOGY. For Footwear Hygiene.



Meritech boot scrubbers are designed to effectively sanitize boots and shoes to ensure that footwear is not a vector for pathogen transmission inside of facilities where employee hygiene is critical.

- Bidirectional photoeye operation.
- Adjustable sole depth.
- Toolless easy brush removal.
- Ready indicator light.
- CIP friendly, hygienic stainless steel design.
- Wash indicator light.
- Main power shut off switch.
- Non-slip surfaces.
- Solution empty indicator light and alarm.
- Optional heavy-duty brushes for stubborn debris.

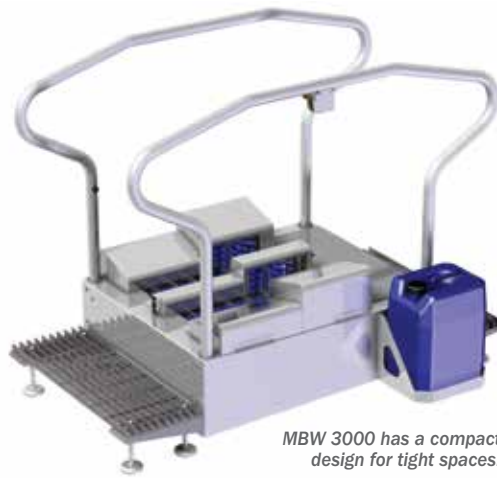
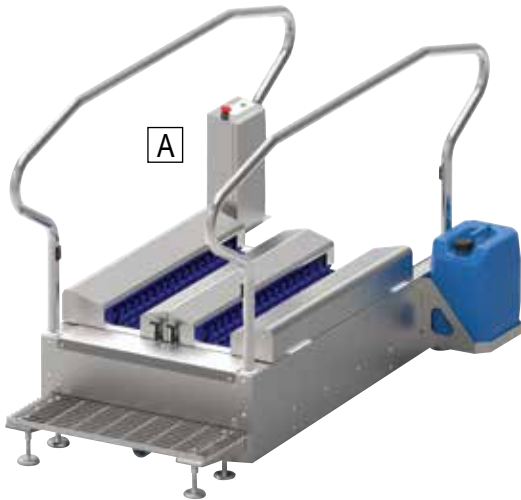

MBW 3000 has a compact design for tight spaces.



Scan this code with your smartphone to learn more about CleanTech®.



ITEM NO.	PRODUCT	MFR. NO.
4435 0007	A. CleanTech® XBW 3.0 Automated Boot Washing Station	XBW3.0
4435 00161	B. CleanTech® MBW 3000 Automated Boot Washing Station	MBW3000
4435 0008	C. BootCleaner XP Footwear Hygiene Solutions – One, 5-Gallon Bottle	305XP-20L

Multiple Styles Available

CALL 800-456-4524 FOR MORE INFORMATION

www.bunzlpd.com



DUNLOP
PROTECTIVE FOOTWEAR

PUROFORT FoodPro Boots

**POUND FOR POUND
A BETTER BOOT**

► SEE PAGES 14-15

► SEE PAGES 88-93

**FOR RAINWEAR
SUITS AND
SEPARATES**



FREE SHIPPING*
FREE GROUND SHIPPING

when you place an order for \$500 or more from
THIS BUYERS GUIDE!

*FREE SHIPPING does NOT include UPS Next Day Air, UPS 2nd Day or UPS 3rd Day Select. Certain items may not qualify. This offer is good only on orders shipped UPS Ground in the 48 contiguous states. Based on dimensional weight, we will determine the most efficient means of shipment, either UPS or LTL. Products may ship by truckline.

SHOP 24/7
bunzlpd.com

CHAT

**Need Help?
Chat With Us
Online!**

STAY CONNECTED WITH US:



Where you can find out
what's on sale, find updated
product information,
reviews and pricing.

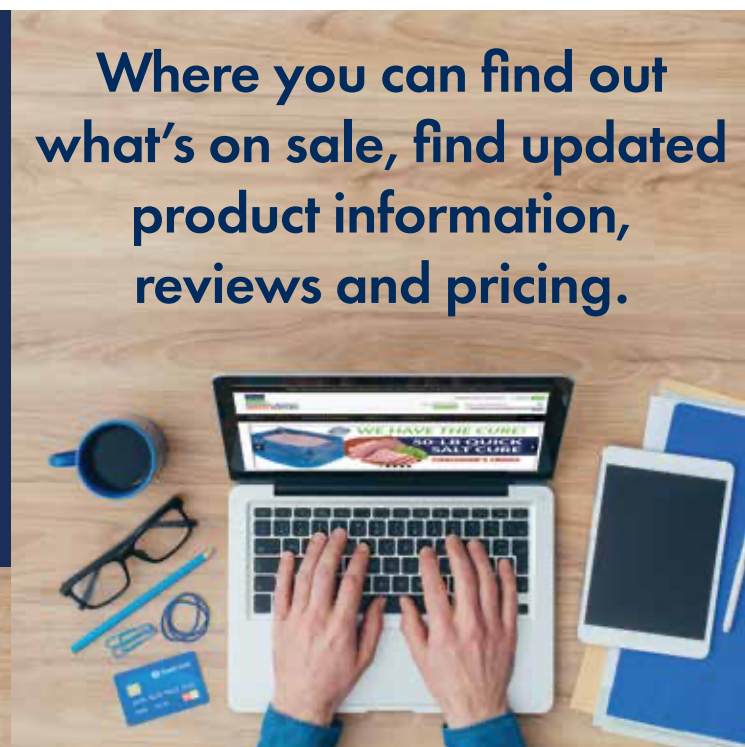

One-piece PVC Injection-Molded Overshoes

Four-way cleated outsole is specifically designed for self cleaning and maximum slip resistance.



- Heavy FLEX-O-THANE construction creates premium overshoe and overboot protection.
- FLEX-O-THANE construction provides added cold weather flexibility and durability.
- Easy entry interior finish.
- Kick-off lug for easy removal.
- Special fold line for snug fit — if desired.



4 Inch

Black

ITEM NO.	MEN'S SIZE
3161 99441	X-Small (4-5)
3161 98991	Small (6-7)
3161 99001	Medium (8-9)
3161 99011	Large (10-11)
3161 99021	X-Large (12-13)
3161 31641	2X-Large (14-15)

▶ 6 PAIR PER CASE.

PAIR
\$31.61

10 Inch

Yellow



ITEM NO.	MEN'S SIZE
3161 32761	X-Small (4-5)
3161 32771	Small (6-7)
3161 32781	Medium (8-9)
3161 32791	Large (10-11)
3161 32801	X-Large (12-13)
3161 32811	2X-Large (14-15)

▶ 6 PAIR PER CASE.

PAIR
\$36.87

10 Inch

Black

ITEM NO.	MEN'S SIZE
3161 98941	X-Small (4-5)
3161 98951	Small (6-7)
3161 98961	Medium (8-9)
3161 98971	Large (10-11)
3161 98981	X-Large (12-13)
3161 44111	2X-Large (14-15)

▶ 6 PAIR PER CASE.

PAIR
\$36.88



17 Inch

Black

ITEM NO.	MEN'S SIZE
3161 27801	X-Small (4-5)
3161 27811	Small (6-7)
3161 27821	Medium (8-9)
3161 27831	Large (10-11)
3161 27841	X-Large (12-13)
3161 27851	2X-Large (14-15)

▶ 6 PAIR PER CASE.

PAIR
\$49.42

Tyvek® Shoe Booties

- Puncture resistant.
- Elastic aperture fits any size foot.
- Available in white and gray.

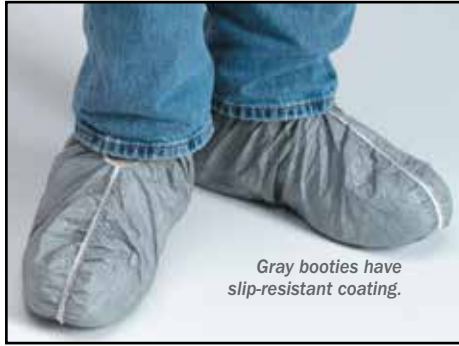

▶ 100 PAIR PER CASE.

ITEM NO.	PRODUCT	CASE
3171 3959	White Shoe Bootie	\$136.95
3125 2000	Gray Shoe Bootie w/Slip-Resistant Coating	140.05

Tyvek® Boot Cover

- Puncture resistant.
- Elastic fits over most boots.



▶ 50 PAIR PER CASE.

ITEM NO.	PRODUCT	CASE
3171 4541	18" White Boot Cover.	\$109.55

Fusion Stationary Shoe Cover Dispenser **SHOE INN**

Stationary, non-electric automatic shoe cover dispenser.

- No electricity needed, it's easily deployed at any suitable locations.
- Intended for medium to high-volume users.
- Made from stainless steel and ABS plastic.
- Holds up to 110 shoe covers and easily loads in bulk, making it easy to maintain in higher volume applications.
- Dimensions: 27-1/2 inches L x 12-1/2 inches W x 8 inches H.
- Weight: 20 pounds.



What is the Shoe Inn Fusion Dispenser? Scan this QR code with your mobile device for info.



4x Faster! Scan this QR code with your mobile device to see the comparison.

ITEM NO.	PRODUCT	F.O.B. FACTORY EACH
G826 71501	Stationary Shoe Cover Dispenser	\$299.05

ITEM NO.	PRODUCT	BUNDLE
G826 17805	A. Coated Spunbound Waterproof (80/Bundle) . . .	\$38.45
G826 17705	B. Coated Spunbound Durable (70/Bundle)	30.45
G826 17905	C. Spunbound Traction Pattern (80/Bundle)	30.65

Dispenser Shoe Covers

- Elastic ankle band allows for a one-size-fits-most fit.
- Cleanroom validated/certified.

Waterproof Shoe Cover

Super anti-skid traction, completely waterproof and durable.

- Super anti-skid coating providing unparalleled traction.
- Color: white.



Durable Shoe Cover

Excellent durability with waterproof bottom layer and moderate traction.

- Durable spunbound polypropylene material with cast polyethylene (CPE) layer for durability.



Traction Pattern Shoe Cover

Good durability, moderate traction and low lint.

- Breathable non-woven fabric shoe cover with good durability and moderate traction.
- Constructed of heavy-duty spunbound polypropylene material with traction pattern.



Reloading Shoe Covers in the Fusion is easy! Scan this QR code with your mobile device to watch the how-to video.



Disposable, Non-Skid Fabric Shoe Covers, Blue

- Light-weight polypropylene fabric.
- Elastic ankle allows for fit over most shoes.
- Resistant to punctures. • Length: 18 inches.



▶ 150 PAIR PER CASE.

ITEM NO.	SIZE	CASE
4724 2118	One Size Fits All	\$83.95

Boot Saver® Disposable Covers

Prevent contamination with color-coded, liquid proof, disposable covers.

- 100% liquid proof protection for boots and shoes.
- Powder-free finish eliminates concerns about powder contamination on clothing, footwear, foods and food-contact surfaces.
- High quality, natural rubber latex stretches easily over boots while remaining resistant to snags, tears and abrasion.
- Ambidextrous — each cover fits both right and left feet.



NOTE: Textured outsole provides grip on both wet and dry surfaces.



▶ 100 PAIR PER CASE.

! WARNING:
This Product Contains Natural Rubber Latex Which May Cause Allergic Reactions.

BLUE	YELLOW	RED	BLACK	SIZE	CASE
4059 0332	4059 0328	4059 0324	4059 0320	Medium (7-9)	\$263.50
4059 0333	4059 0329	4059 0325	4059 0321	Large (9-11)	263.50
4059 0334	4059 0330	4059 0326	4059 0322	X-Large (11-14)	263.50
4059 0335	4059 0331	4059 0327	4059 0323	2X-Large (15+)	263.50



Embossed Blue Shoe Covers

- Constructed of waterproof co-polymer.
- Elastic top to keep shoes clean.
- Embossed tread provides slip-resistance for both wet and dry applications.

▶ 100 PER BAG.

ITEM NO.	SIZE	BAG
7195 16345	X-Large	\$19.57

WorkHorse® Disposable Poly Shoe Covers



- Poly covers fit over shoes or boots.
- Dispenser roll for easy access.
- 3 mil polyethylene.



▶ 50 COVERS PER BAG — 10 BAGS PER CASE.

ITEM NO.	PRODUCT	BAG
E542 15151	One Size	\$15.98

WorkHorse® Blue Poly Shoe Covers, 3 Mil



- Constructed of heavy-duty polyethylene.
- Elastic top to keep boots clean.



▶ 50 COVERS PER BAG — 10 BAGS PER CASE.

ITEM NO.	PRODUCT	BAG
E542 15161	One Size	\$15.98

Blue Boot Covers, 4 Mil

- Knee-high, low-leg and foot protection.
- Ideal for use where biological and chemical liquids are present.
- Elastic top to keep boots clean.



▶ 50 PAIR PER CASE.

ITEM NO.	PRODUCT	CASE
3386 9350	Regular	\$171.11
3386 9550	Large	184.42

Brown Duck Insulated Outerwear

Medium-weight insulated quilt-lined taffeta is warm and durable. Duck shell is water repellent and machine washable.

100% Cotton, 10-Ounce Coverall

Coverall has 2 zippered chest pockets, 2 hip pockets (left with zipper) and 2 front pockets.



100% Cotton, 10-Ounce, Blanket-Lined Hooded Jacket and Overalls

Hooded Jacket has 10 ounce 808 Hollofil® insulation and 2 angled slash pockets.



10 ounce 808 Hollofil® insulation quilted to 100% nylon liner.

▶ 6 PER CASE.

ITEM NO.	PRODUCT	EACH
3385 34211	Coverall, Small	\$101.55
3385 34221	Coverall, Medium	101.55
3385 34241	Coverall, Large	101.55
3385 34251	Coverall, X-Large	101.55
3385 34261	Coverall, 2X-Large	101.55
3385 34171	Coverall, 3X-Large	119.65
3385 34181	Coverall, 4X-Large	119.65
3385 34191	Coverall, 5X-Large	123.55
3385 34741	Brown Snap-On Hood	\$17.05

▶ 6 PER CASE.

ITEM NO.	PRODUCT	EACH
3385 42121	Overall, Small	\$80.35
3385 42131	Overall, Medium	80.35
3385 42141	Overall, Large	80.35
3385 42151	Overall, X-Large	80.35
3385 42161	Overall, 2X-Large	80.35
3385 42171	Overall, 3X-Large	84.05
3385 42181	Overall, 4X-Large	84.05
3385 42191	Overall, 5X-Large	95.65

▶ 6 PER CASE.

ITEM NO.	PRODUCT	EACH
3385 00101	Jacket, Small	\$65.55
3385 00111	Jacket, Medium	65.55
3385 00121	Jacket, Large	65.55
3385 00131	Jacket, X-Large	65.55
3385 00141	Jacket, 2X-Large	65.55
3385 00151	Jacket, 3X-Large	66.95
3385 00161	Jacket, 4X-Large	66.95
3385 00171	Jacket, 5X-Large	72.95



7.5-Ounce, Quilt-Lined, Insulated Chore Coat

- Constructed of 100% cotton duck. • Edge stitched corduroy collar with hood snaps.
- Zippered and velcro front closure. • Two-piece button cuff.
- Two chest pockets (velcro closure), double inside cargo pocket and two oversized patch pockets.

▶ 6 PER CASE

ITEM NO.	PRODUCT	EACH
3385 14111	Black, Medium	\$53.55
3385 14121	Black, Large	53.55
3385 14131	Black, X-Large	53.55
3385 14141	Black, 2X-Large	53.55
3385 14151	Black, 3X-Large	58.35
3385 14161	Black, 4X-Large	60.75
3385 01001	Black, Snap-On Hood	17.05
3385 34111	Brown, Medium	\$72.85
3385 34121	Brown, Large	72.85
3385 34131	Brown, X-Large	72.85
3385 34141	Brown, 2X-Large	72.85
3385 34151	Brown, 3X-Large	79.85
3385 00741	Brown, 4X-Large	79.85
3385 34741	Brown Snap-On Hood	17.05



Optional snap-on hood.



7.4-Ounce, Insulated Cooler Jackets and Vests, Blue with Red Lining

- Insulated with 7.4 ounces of DuPont Dacron 808® fiber fill.
- Two insulated hand warmer pockets.
- 100% nylon outer shell. • Machine washable.
- Heavy-duty nylon zipper holds up to machine washing.

Vest

ITEM NO.	SIZE	EACH
4648 50271	Small	\$30.95
4648 50281	Medium	30.95
4648 50291	Large	30.95
4648 50301	X-Large	30.95
4648 50311	2X-Large	35.95
4648 55801	3X-Large	42.95
4648 55811	4X-Large	42.95



7.4 Ounce, Hi-Viz Orange

ANSI Class 2 compliant.

- Insulated with 7.4 ounces of DuPont Dacron 808® fiber fill.
- Two insulated hand warmer pockets.
- Machine washable. • 100% nylon outer shell.
- Heavy-duty brass zipper.

Hi-Viz Jacket

ITEM NO.	SIZE	EACH
4648 49601	Small	\$80.35
4648 49611	Medium	80.35
4648 49621	Large	80.35
4648 49631	X-Large	80.35



Heavy-duty nylon zipper.

Jacket

ITEM NO.	SIZE	EACH
4648 50221	Small	\$53.75
4648 50231	Medium	53.75
4648 50241	Large	53.75
4648 50251	X-Large	53.75
4648 50261	2X-Large	58.95
4648 28221	3X-Large	62.95
4648 28231	4X-Large	67.55
4648 28241	5X-Large	76.15

Hi-Viz Vest

ITEM NO.	SIZE	EACH
4648 49501	Small	\$60.05
4648 49511	Medium	60.05
4648 49521	Large	60.05
4648 49531	X-Large	60.05



KOOLERWEAR

MADE IN USA



11.5-Ounce Insulated Separates

Nylon duck outer covering 11.5 ounces 808 DuPont HolloFil® insulation.

13.7-Ounce Insulated Separates

420-denier nylon duck outer covering 13.7 ounce DuPont HolloFil® insulation.



High back bib with elasticized waist provides extra warmth and protection to the lower back and kidneys.



Optional lined hood with Velcro® and drawstring closure.

Heavy-duty nylon zippers hold up when machine washed.

PROTECTS DOWN TO
| -45 °F |

▶ 6 PER CASE.

11.5-Ounce Separates

ITEM NO.	SIZE	EACH
4648 02021	Waist-Length Jacket, Small	\$119.95
4648 02031	Waist-Length Jacket, Medium	119.95
4648 02041	Waist-Length Jacket, Large	119.95
4648 02051	Waist-Length Jacket, X-Large	119.95
4648 02061	Waist-Length Jacket, 2X-Large	119.95
4648 02071	Waist-Length Jacket, 3X-Large	141.95
4648 02081	Waist-Length Jacket, 4X-Large	153.95
4648 02091	Waist-Length Jacket, 5X-Large	164.95
4648 02101	Waist-Length Jacket, 6X-Large	186.95
4648 03011	Overalls, Small	\$119.95
4648 03021	Overalls, Medium	119.95
4648 03031	Overalls, Large	119.95
4648 03041	Overalls, X-Large	119.95
4648 03051	Overalls, 2X-Large	141.95
4648 03061	Overalls, 3X-Large	153.95
4648 03071	Overalls, 4X-Large	164.95
4648 03081	Overalls, 5X-Large	186.95
4648 03091	Overalls, 6X-Large	197.95
4648 14141	Optional Hood, One Size Fits All	\$26.35



Heavy-duty snaps and 2-way nylon zipper.

Extra-deep, insulated pockets are double-stitch reinforced.

Storm front fly with snaps, no exposed zippers for moisture protection.

Knit cuffs.

All stress points are bar-tack reinforced.

PROTECTS DOWN TO
| -50 °F |



Jackets have red lining.

Storm snap leg flies with ankle to hip heavy-duty, 28-inch nylon zipper on overalls.

▶ 6 PER CASE.

13.7-Ounce Separates

ITEM NO.	SIZE	EACH
4648 20201	Fingertip-Length Jacket, Small	\$152.95
4648 20211	Fingertip-Length Jacket, Medium	152.95
4648 20221	Fingertip-Length Jacket, Large	152.95
4648 20231	Fingertip-Length Jacket, X-Large	152.95
4648 20241	Fingertip-Length Jacket, 2X-Large	152.95
4648 20191	Fingertip-Length Jacket, 3X-Large	186.95
4648 20171	Fingertip-Length Jacket, 4X-Large	197.95
4648 20251	Overalls, Small	\$164.95
4648 20261	Overalls, Medium	164.95
4648 20271	Overalls, Large	164.95
4648 20281	Overalls, X-Large	164.95
4648 20291	Overalls, 2X-Large	174.95
4648 20181	Overalls, 3X-Large	197.95
4648 91041	Overalls, 4X-Large	217.95
4648 20301	Optional Hood, One Size Fits All	\$40.45



420-denier nylon duck outer covering 13.7-ounce DuPont HolloFil® insulation.

13.7-Ounce Insulated Knee-Length Coat

- Knit cuffs. • Nylon zipper.

PROTECTS DOWN TO
| -50°F |



Knee-Length Coat

ITEM NO.	SIZE	EACH
4648 20361	Small	\$180.95
4648 20371	Medium	180.95
4648 20381	Large	180.95
4648 20391	X-Large	180.95
4648 20401	2X-Large	190.95
4648 20441	3X-Large	200.95

CUSTOM EMBROIDERY AVAILABLE

Would you like your company logo or employee names custom embroidered on your clothing?

1. Choose **BLOCK** or *Script* lettering.
2. Choose your lettering color.
3. Choose location of embroidery (left or right).

YOUR NAME *Dave*

	1-2	1-2	12+
1-Line of Text . . .	\$8.40	\$6.30	\$5.25
Multiple Lines . . .	CALL FOR PRICING		

CALL 800-456-5624 for more information and to place your order.

GENERAL SIZE CHART

SIZE	WEIGHT	CHEST SIZE	WAIST SIZE
Small	115 - 145 lb	34" - 26"	28" - 30"
Medium	150 - 170 lb	38" - 40"	32" - 34"
Large	175 - 195 lb	42" - 44"	36" - 38"
X-Large	200 - 225 lb	46" - 48"	40" - 42"
2X-Large	225 - 245 lb	50" - 52"	44" - 46"
3X-Large	245 - 265 lb	54" - 56"	48" - 50"
4X-Large	265 - 285 lb	58" - 60"	52" - 54"

Optional 13.7-ounce Thick Orlon® pile lined hood with Velcro® and drawstring closure.



Coat has red lining.



Heavy-duty nylon zippers hold up when machine washed.

13.7-Ounce Insulated Coveralls

- Synthetic fur collar. • Knit cuffs.
- Nylon zipper.

PROTECTS DOWN TO
| -50°F |



Coveralls

ITEM NO.	SIZE	EACH
4648 20311	Small	\$227.95
4648 20321	Medium	227.95
4648 20331	Large	227.95
4648 20341	X-Large	227.95
4648 20351	2X-Large	248.95
4648 00361	3X-Large	283.95
4648 00371	4X-Large	304.95
4648 00381	5X-Large	349.95

▶ 3 PER CASE.

▶ 5 PER CASE.

6.6-Ounce Durable Economy Insulated Clothing

Durable performance outerwear that will last for years in harsh environments.

- Insulated with a 6.6-ounce fiberfill.
- 100%, 200-denier nylon outer shell.
- Knit wrists and collar. • Machine washable.
- Color: navy blue.



Aluminum metal zipper.

Two pockets.

Vest

ITEM NO.	SIZE
3279 0030	Small
3279 0031	Medium
3279 0032	Large
3279 0033	X-Large
3279 0034	2X-Large
3279 0035	3X-Large

EACH

\$27.62



Knit collar and cuffs.

Jacket

ITEM NO.	SIZE
3279 0020	Small
3279 0021	Medium
3279 0022	Large
3279 0023	X-Large
3279 0024	2X-Large
3279 0025	3X-Large

EACH

\$39.40

RefrigiWear®

7.5-Ounce Insulated Cooler Vest and Jacket

Insulation is rated down to 0 °F.

- 7.5-ounce polyester fiberfill insulation provides light-weight warmth.
- Rip-stop nylon outer shell for greater flexibility.
- Storm fly front with brass snaps, no exposed zippers for moisture protection.
- Bound seams increase durability.



Insulated knit collar.

Vest

ITEM NO.	SIZE
0158 0369	Small
0158 0364	Medium
0158 0365	Large
0158 0366	X-Large
0158 0367	2X-Large

▶ 6 PER CASE.

EACH

\$46.05

PROTECTS
DOWN TO
| 0°F |

Jacket

ITEM NO.	SIZE
0158 05251	Small
0158 05261	Medium
0158 05271	Large
0158 05281	X-Large
0158 05291	2X-Large

▶ 6 PER CASE.

EACH

\$62.14



Insulated knit collar and cuffs.

6.6-Ounce Durable Economy Frock Liner

Durable performance frock liner that will last for years in harsh environments.

- Insulated with a 6.6-ounce fiberfill.
- 100%, 200-denier nylon outer shell.
- Knit wrists and collar.
- Machine washable.
- Color: navy blue.



Reach-thru side slits.

NOTE: Frock sold separately.

ITEM NO.	SIZE
3279 0010	Small
3279 0011	Medium
3279 0012	Large
3279 0013	X-Large
3279 0014	2X-Large
3279 0015	3X-Large

▶ 6 PER CASE.
EACH
\$42.45

KOOLERWEAR

7.4-Ounce Insulated Frock Liner

Warm, layered protection.

- Cotton/poly blend is machine washable.
- Knit collar and cuffs.
- Corrosion-resistant brass snaps.
- Reach-thru side slits.



Insulated knit collar and cuffs.

NOTE: Frock sold separately.

▶ 6 PER CASE.

ITEM NO.	SIZE	EACH
4648 55151	Small	\$62.65
4648 55161	Medium	62.65
4648 55171	Large	62.65
4648 55181	X-Large	62.65
4648 55191	2X-Large	64.15
4648 55231	3X-Large	69.95

RefrigiWear

7.5-Ounce Insulated Frock Liner

- 7.5-ounce polyester fiberfill insulation provides light-weight warmth.
- Rip-stop nylon outer shell for greater flexibility.
- Storm fly front with brass snaps, no exposed zippers for moisture protection.
- Bound seams increase durability.

NOTE: Frock sold separately.



Extra-deep, insulated pockets are easily accessible with side seam openings.

Knee-length style.

ITEM NO.	SIZE	EACH
0158 0343	Small	▶ 6 PER CASE.
0158 0344	Medium	
0158 0345	Large	EACH
0158 0346	X-Large	\$79.31

▶ SEE PAGES 86-87

FROCKS SOLD SEPARATELY

Hooded Thermal Zip-Front Jacket

This is not your average sweatshirt! Cotton/Poly fleece shell with a 5-ounce thermal lining for added warmth.

- Full-length zipper and two-needle stitched main seams for durability.
- Double-layered three-piece hood with drawstring closure.
- Oversized front pockets.
- Elasticized knit waistband.
- Storm knit cuffs.
- Color: navy.



ITEM NO.	SIZE
3385 54811	Small
3385 54821	Medium
3385 54831	Large
3385 54841	X-Large
3385 54851	2X-Large
3385 54861	3X-Large

▶ 6 PER CASE.

EACH
\$44.45

▶ SEE PAGE 311

FOR ADDITIONAL HARD HAT ACCESSORIES



V-Gard®
frame and
clear visor.

Watch Cap

- Constructed of Thinsulate™ to trap heat and repel water.
- Color: safety orange.

MADE IN
USA



ITEM NO.	PRODUCT
0181 41441	One Size Fits All

EACH
\$9.09

Knit Face Mask with Quilting

- Soft thermal knit hood made from a navy polypropylene acrylic blend.
- DuPont HolloFil® insulated, quilted, light-weight nylon front with detachable face.

MADE IN
USA



ITEM NO.	PRODUCT	EACH
3409 42031	One Size Fits All	\$16.95

Neofleece® Combo Clava

- Waterproof, windproof Polartec™ fleece outershell.
- Neofleece® moisture-wicking facemask. • Mouthpiece with breathing holes.
- Wear as balaclava, open hole mask or gaiter. • Color: black.

RefrigiWear

Knit Face Mask

- Constructed of Thinsulate™ to trap heat and repel water.
- 100% acrylic.
- Color: navy.



ITEM NO.	PRODUCT
0181 80281	One Size Fits All

EACH
\$6.45



ITEM NO.	PRODUCT	EACH
0158 10921	One Size Fits All	\$38.08

Reversible Looped Terry Gloves



- Withstands sub-zero temperatures.
- 70% polyester acrylic, 30% blend is shrink-resistant.
- Comfortable, 28-ounce looped terry cloth is seamless and ambidextrous.
- Washable.



ITEM NO.	PRODUCT	PAIR
3430 56041	One Size Fits All	\$5.95

North Polar[®] Insulated Leather Palm Gloves



- Waterproof liner keeps hands dry in wet conditions.
- Thinsulate[®] liner protects hands and wrists from cold temperatures.
- Blue leather palm with yellow back and a knit wrist safety cuff.
- Recommended for temperatures down to -36 °F (-38 °C).



PROTECTS DOWN TO
| -36 °F |

ITEM NO.	PRODUCT	PAIR
3476 70641	One Size Fits All	\$32.87

NorthFlex - Cold Grip[™] Gloves



Foamed PVC palm-coated, lined gloves.

- Recommended for temperatures down to -15 °F (-26 °C).
- Seamless brushed synthetic liner provides superior insulation from the cold.
- Form fitting design.
- Provides excellent wet and dry grip.

PROTECTS DOWN TO
| -15 °F |



ITEM NO.	SIZE
3476 86351	Size 8/Medium
3476 86361	Size 9/Large
3476 86371	Size 10/X-Large
3476 86381	Size 11/2X-Large

► 12 PAIR PER CASE.

PAIR
\$10.76

PowerGrab[™] Thermo Gloves

Hi-vis seamless knit acrylic terry glove with latex microfinish grip on palm and fingers.

- Excellent thermal insulation.
- Quickly evaporates moisture from the skin.
- Extra softness for non-chafing comfort.
- Excellent launderability characteristics.
- Complies with FDA food handling requirements, 21 CFR 177.2600.
- 10 gauge.



Hi-Vis Orange

ITEM NO.	SIZE	CUFF
6292 14005	Small	Green
6292 14015	Medium	Blue
6292 14025	Large	Tan
6292 14035	X-Large	Gray
6292 14045	2X-Large	Purple



Hi-Vis Yellow

ITEM NO.	SIZE	CUFF
6292 1151	Small	Green
6292 11535	Medium	Blue
6292 10545	Large	Tan
6292 10495	X-Large	Gray

► 6 DOZEN PAIR PER CASE.

CASE
\$136.25

No 2XL size.

GET A GRASP ON THE RIGHT GLOVE FOR YOU

Eliminate the guesswork when ordering gloves, just ask yourself the following questions:

What Size Gloves Should I Order?

This is very important, because a glove that is either too tight or too loose can be both uncomfortable and hazardous in the workplace.

GLOVE SIZE CHART

X-SMALL	SMALL	MEDIUM	LARGE	X-LARGE
6-7	7-8	8-9	9-10	10-11

How to find your size:

Measure the widest part of your hand, starting above your thumb and measuring across the palm and around the back of your hand (see right). The size in inches corresponds to the size of the glove (i.e. if your hand measures 8 inches, then you should wear a size 8 glove).



Which Glove Length Should I Choose?

The length of glove you should order is directly related to the application for which it is to be used. Select glove length by determining the depth to which your arm will be immersed in liquids, or whether it is to be used for splash protection.

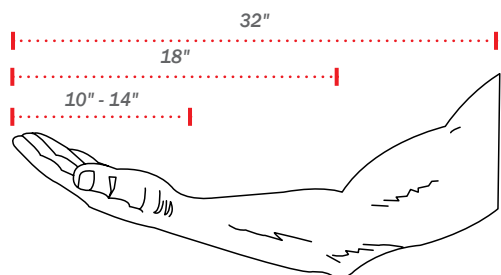

- **Wrist and Forearm Lengths (10" - 14")** – Protects the hand and wrist for most applications.
- **Elbow Lengths (18")** – Offers splash protection and immersion capability.
- **Shoulder Lengths (32")** – Ideal for full arm immersion applications.

Generally, the length of a glove is measured from the tip of the middle finger to the outer edge of the cuff.

What Types of Glove Cuffs Are Available?

There are five different types of cuffs from which to choose. Not all styles are available for every glove – the cuffs differ according to application.



Straight Cuff



Rolled Cuff



Pinked Cuff



Safety Cuff



Knit Wrist Cuff

The five most common cuff styles are:

- **Straight Cuff** – Offer a snug fit around the wrist.
- **Rolled Cuff** – Added protection to the skin from liquid and chemical run-off.
- **Pinked Cuff** – Used on knit-lined gloves to minimize raveling.
- **Safety Cuff** – A short, open cuff made from stiff material to provide added protection to the wrist area.
- **Knit Wrist Cuff** – Enhance warmth and provide a close fit to prevent debris from entering glove.

Do Glove Linings Make A Difference?

Linings make a difference in the comfort of the glove and they also have some added benefits that can be of value for certain applications.

- **Flock Lining** – Shredded cotton or synthetic fiber applied to the interior of the glove. Absorbs moisture making gloves easier to put on and remove.



Flock Lining



Knit Lining



Unlined

- **Knit Lining** – Cotton or synthetic material knitted to the interior of the glove. Knit linings absorb perspiration and makes gloves easy to put on and remove.
- **Unlined** – Offer superior tactile sensitivity and greater dexterity than lined. Unlined gloves with powdered interiors make them easier to put on and remove.

What Are My Options for Non-Waterproof Gloves?



Polyester/Cotton – Poly/cotton blends are commonly used in string knit gloves because of their comfort, durability and excellent laundering characteristics. By mixing polyester with cotton, shrinkage can be minimized.



Kevlar® – Kevlar is a man-made organic fiber developed for use in high performance applications. The par-aramid fiber has a high-resistance to cuts and slashes which makes it ideal for use in applications where sharp objects are being used. The high tensile strength and low weight of Kevlar makes it durable yet light-weight to wear. Kevlar is flame resistant, self-extinguishes and can be used in elevated temperatures.



Blended Kevlar/Cotton/Polyester – As gloves are knit, Kevlar is mechanically blended on the outside of the gloves to provide cut protection. Only a few Kevlar threads are woven into the cotton and polyester threads that are used on the inside to provide a very comfortable protective-glove material.



Leather – Leather is the hide, or skin of an animal. The most widely used leather for gloves is cowhide. Other leathers used are pigskin, goat skin and deerskin. Leather is used because it offers abrasion resistance, is flexible and allows air through its pores. Hides are processed in tanneries by applying chrome sulfate and bichromate of potash (the reason they are called “chrome tanned”) along with coloring agents. After processing, the hides are split. The durability of leather is in direct proportion to its thickness, not to its location on the animal.



Grain Leather – The leather is in the outer, or hair, side of the hide. It is split off the side or belly. Side grain has few cosmetic blemishes. It varies in thickness and is supple. The leather is generally used in garments. Belly grain are small hides that are consistent in thickness and have a good feel.

WATERPROOF GLOVE COMPARISON CHART



PHYSICAL PERFORMANCE PROPERTIES	NITRILE	NEOPRENE	LATEX	NEOPRENE OVER LATEX	NITRILE OVER LATEX	VINYL	POLY
Tensile Strength	EXCELLENT	EXCELLENT	EXCELLENT	EXCELLENT	EXCELLENT	FAIR	POOR
Elongation	EXCELLENT	EXCELLENT	EXCELLENT	EXCELLENT	EXCELLENT	FAIR	POOR
Abrasion Resistance	EXCELLENT	GOOD	GOOD	GOOD	GOOD	GOOD	POOR
Tear Resistance	FAIR	GOOD	GOOD	GOOD	FAIR	POOR	POOR
Puncture Resistance	FAIR	GOOD	GOOD	GOOD	GOOD	POOR	POOR
Aging/Shelf Life	EXCELLENT	EXCELLENT	GOOD	GOOD	GOOD	FAIR	FAIR
Flame Resistance	POOR	GOOD	POOR	GOOD	POOR	POOR	POOR
Heat Resistance	POOR	EXCELLENT	FAIR	GOOD	GOOD	POOR	POOR
Cold Resistance	POOR	GOOD	EXCELLENT	GOOD	EXCELLENT	FAIR	POOR
Flexibility	EXCELLENT	GOOD	GOOD	EXCELLENT	EXCELLENT	EXCELLENT	EXCELLENT
Dry Grip	GOOD	GOOD	GOOD	GOOD	GOOD	GOOD	POOR
Wet Grip	GOOD	GOOD	FAIR	GOOD	GOOD	FAIR	POOR
Animal Fat Resistance	EXCELLENT	GOOD	POOR	GOOD	EXCELLENT	GOOD	FAIR
Solvent Resistance	GOOD	FAIR	POOR	FAIR	GOOD	FAIR	POOR
Blood Resistance	EXCELLENT	GOOD	EXCELLENT	EXCELLENT	EXCELLENT	FAIR	FAIR



WARNING:

Some products in this catalog may expose you to chemicals including DEHP Di (2-ethylhexyl) phthalate or BPA (Bisphenol A) which are known to the State of California to cause cancer or birth defects or other reproductive harm. For more information, visit www.P65Warnings.ca.gov.

Kevlar®/Nomex® Seamless Gloves



Good for applications where heat protection and dexterity is required.

- Provides excellent thermal properties, allowing wearer to handle hot objects.
- Knit, continuous cuff.
- Ambidextrous.

PROTECTS UP TO |500°F|



NOTE: These gloves are sold individually, NOT as a pair.

ITEM NO.	SIZE
4164 26081	Small
4164 26091	Medium
4164 26101	Large

▶ 12 PER CASE.

EACH \$13.54

Grip N® Hot Mill Gloves

Honeywell

- Protection from intermittent contact with hot surfaces up to 400 °F.
- Outer shell is made of a cotton/acrylic blend that is nitrile coated for improved grip and longer life.
- Knitted, seamless construction provides superior comfort and lessens hand fatigue.
- Machine washable.
- One size fits all.

PROTECTS UP TO |400°F|



7 GAUGE

▶ 6 DOZEN PAIR PER CASE.

ITEM NO.	PRODUCT	DOZEN PAIR
3476 89705	Grip N® Hot Mill Gloves	\$97.88

Terry Cloth Baker's Gloves

Perfect for grabbing hot trays, pans and utensils.

- Extra thick terry glove with sewn wrist band.
- Machine washable.
- One size fits all.

▶ SEE PAGE 69 For Bouffant Caps



▶ 10 DOZEN PAIR PER CASE.

ITEM NO.	PRODUCT	DOZEN PAIR
6292 27045	Medium-Weight (18 oz.) 300 °F.	\$29.65
6292 27005	Heavy-Weight (24 oz.) 450 °F.	34.65

Extra-Heavy-Weight 11-Inch Gauntlets

- 32-ounce terry protects up to 320 °F.
- Looped out gauntlet finished with brown piping.
- Clute cut with straight thumb.
- Premium cut and sewn heavy-duty terry cloth.
- Unparalleled comfort and flexibility.
- Terry cloth natural insulation.
- Pre-laundered. • Machine washable.



PROTECTS UP TO |320 °F|

▶ 3 DOZEN PAIR PER CASE.

ITEM NO.	PRODUCT	DOZEN PAIR
3314 16925	Large Size Fits All	\$76.95

Heavy-Weight Wrist-Length Gloves

- 28-ounce terry protects up to 250 °F.
- Black-striped knit wrist.
- Gunn cut with inset thumb.
- Terry cloth natural insulation
- Unparalleled comfort and flexibility.
- Premium cut and sewn heavy-duty terry cloth.
- Reversible. • Pre-laundered. • Machine washable.



PROTECTS UP TO |250 °F|

▶ 6 DOZEN PAIR PER CASE.

ITEM NO.	PRODUCT	DOZEN PAIR
3314 16885	Large Size Fits All	\$29.55

Extra-Heavy-Weight High Heat 5-Inch Gauntlets

- 32-ounce terry protects up to 450 °F.
- 10-ounce jersey lining.
- Gunn cut with inset thumb.
- Premium cut and sewn heavy-duty terry cloth.
- Loop out gauntlet finished with brown piping.
- Terry cloth natural insulation. • Unparalleled comfort and flexibility.
- Reversible. • Pre-laundered.
- Machine washable.



PROTECTS UP TO |450 °F|

▶ 3 DOZEN PAIR PER CASE.

ITEM NO.	PRODUCT	DOZEN PAIR
3314 16905	X-Large Size Fits All	\$102.95

Terry Cloth Baker's Sleeve

- Thick 14-inch terry sleeve with knit wrist.
- Elastic top secures sleeve to upper arm.
- Machine washable.



► SEE PAGE 72
For Reusable and Poly Sleeves

**PROTECTS
UP TO
|350 °F|**

► 12 PER CASE.

ITEM NO.	PRODUCT	EACH
4164 15151	One Size Fits All	\$6.94



Terry Cloth Baker's Pad

- Two layers of extra-heavy-weight terry cloth protect up to 460 °F.
- Provides protection against hot trays, pans and other utensils.
- Machine washable.



**PROTECTS
UP TO
|460 °F|**



Hand hole in pad for ease of use.

ITEM NO.	PRODUCT	EACH
4164 00081	9-1/2" x 11"	\$3.53

SHOP 24/7
bunzlpd.com



Need Help?
Chat With Us
Online!

STAY CONNECTED WITH US:



Where you can find out
what's on sale, find updated
product information,
reviews and pricing.





North® Nitri-Knit™ Supported Nitrile Coated Gloves

High performance supported nitrile gloves, excellent protection against solvents, caustics and animal fats.

- Complies with USDA and FDA regulations, 21 CFR, for use in food processing.
- Gloves will not swell, sag or weaken from fat absorption.
- Nitrile offers superior mechanical strength and outperforms supported natural rubber, neoprene and vinyl gloves when exposed to solvent, caustics and animal fats.
- True dip coated glove has a permanent bond of nitrile to inner-liner; won't peel apart.
- Pebble textured for added grip on wet or dry surfaces.
- Hand portion is treated with a permanent anti-bacterial and anti-mildew agent.
- Insulated versions recommended for temperatures from -10 °F to 300 °F (-23 °C to 149 °C).

NOTE: Order one size larger in this style of glove.



PROTECTS UP TO |300 °F|

Insulated gloves provide added protection for hot or cold applications. Recommended temperatures -10 °F to 300 °F.

Pebbled grip finish.



12 inch short length.



26 inch shoulder length.

Insulated

12 Inch Short Length

ITEM NO.	SIZE
3476 83371	Size 7
3476 83381	Size 8
3476 83391	Size 9
3476 83401	Size 10
3476 83411	Size 11

▶ 6 PAIR PER CASE.

PAIR
\$18.07

26 Inch Shoulder Length

ITEM NO.	SIZE
3476 80421	Size 7
3476 80431	Size 8
3476 80441	Size 9
3476 80451	Size 10
3476 80461	Size 11

▶ 6 PAIR PER CASE.

PAIR
\$46.49

Non-Insulated

12 Inch Short Length

ITEM NO.	SIZE
3476 81391	Size 9
3476 81401	Size 10
3476 81411	Size 11

▶ 12 PAIR PER CASE.

PAIR
\$11.38

26 Inch Shoulder Length

ITEM NO.	SIZE
3476 80371	Size 7
3476 80381	Size 8
3476 80391	Size 9
3476 80401	Size 10
3476 80411	Size 11

▶ 6 PAIR PER CASE.

PAIR
\$28.44



Neoprene Supported Fryer Gloves

Ideal for restaurant deep fryer grease, broiler and oil applications.

- NOT recommended for open flame contact.
- Etched rough finish. • Length: 18 inches.
- One size fits all.

PROTECTS UP TO |450 °F|

Available with built-in liner or 100% heavy cotton double jersey removable liner.

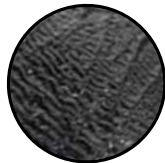

Etched rough finish on hand area



Sewn in loop

▶ 12 PAIR PER CASE.

ITEM NO.	PRODUCT	PAIR
4663 41851	With Removable Heavy-Duty Liner	\$38.40
4663 31851	With Built-In Liner	27.55

Insulated PVC Gloves

- Single-dipped PVC coating for wet or dry grip.
- Foam insulation between interlock cotton and cotton fleeced jersey.
- Resistant to abrasions, oils, acids, chemicals and caustics.
- Special liquid-resistant coating allows flexibility, even in cold weather.



► 5 DOZEN PAIR PER CASE.

ITEM NO.	PRODUCT	DOZEN PAIR
3314 40265	One Size Fits All	\$70.68

Economy PVC Coated Single-Dipped Gloves

- Single-dipped PVC to help protect hands from liquids, mild chemicals, solvents and acids.
- Black 12-inch gauntlet retains a good grip on objects in both wet and dry conditions.
- Interlocked lining allows for easy laundering.



► 10 DOZEN PAIR PER CASE.

ITEM NO.	PRODUCT	DOZEN PAIR
3314 6212	One Size Fits All	\$27.12

Economy PVC Double-Dipped Gloves

Double-dipped PVC for added protection from liquids, mild chemicals, solvents and acids.

- Black 12-inch gauntlet has a sandy finish for better grip in both wet and dry conditions.
- Interlocked lining allows for easy laundering.



► 12 DOZEN PAIR PER CASE.

ITEM NO.	PRODUCT	DOZEN PAIR
3314 65225	One Size Fits All	\$44.78

Black PVC Coated Canvas Gloves

- Ideal for high-wear situations where frequent replacement is likely.
- Provides resistance to abrasion, mild chemicals, oils, solvents and strong acids.
- Interlock lining allows for easy laundering.
- Dipped with a smooth finish for good grip in wet and dry conditions.



► 10 DOZEN PAIR PER CASE.

ITEM NO.	PRODUCT	DOZEN PAIR
6292 80155	One Size Fits All	\$30.65



WARNING:

Some products in this catalog may expose you to chemicals including DEHP Di (2-ethylhexyl) phthalate or BPA (Bisphenol A) which are known to the State of California to cause cancer or birth defects or other reproductive harm. For more information, visit www.P65Warnings.ca.gov.

MaxiFoam® Premium Gloves

Seamless knit nylon with a foam nitrile grip is the perfect combination for oily applications.

- Designed to channel oil away from the glove surface for an excellent grip.
- Soft comfortable interior.



ITEM NO.	SIZE	CUFF HEM
6292 48005	Small	White
6292 48015	Medium	Green
6292 48025	Large	Brown
6292 48035	X-Large	Yellow

▶ 12 DOZEN PAIR PER CASE.

DOZEN PAIR
\$63.85

MaxiFlex® Ultimate™ Gloves

Seamless knit nylon with a breathable Micro-Foam nitrile grip keeps hands cool and dry.

- Contoured hand shape for a perfect fit.
- Breathable coating keeps gloves cool and comfortable.
- Gray and black color combination is perfect for industrial applications.
- Soft comfortable interior.

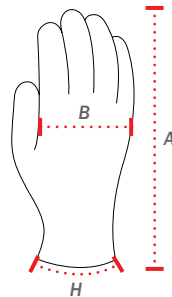

ITEM NO.	SIZE	CUFF HEM
6292 48745	Small	White
6292 48755	Medium	Green
6292 48765	Large	Brown
6292 48775	X-Large	Yellow

▶ 12 DOZEN PAIR PER CASE.

DOZEN PAIR
\$82.55

	S	M	L	XL
A	8.1"/20.5 cm	8.5"/21.5 cm	8.7"/22.0 cm	8.9"/22.5 cm
B	3.2"/8.2 cm	3.3"/8.4 cm	3.7"/9.4 cm	3.8"/9.7 cm
H	White	Green	Brown	Yellow

PowerGrab™ Thermo Gloves

Hi-vis seamless knit acrylic terry glove with latex microfinish grip on palm and fingers.

- Excellent thermal insulation. • Quickly evaporates moisture from the skin.
- Extra softness for non-chafing comfort.
- Excellent launderability characteristics. • 10 gauge.
- Complies with FDA food handling requirements, 21 CFR 177.2600.

Hi-Vis Orange

ITEM NO.	SIZE	CUFF
6292 14005	Small	Green
6292 14015	Medium	Blue
6292 14025	Large	Tan
6292 14035	X-Large	Gray
6292 14045	2X-Large	Purple



Hi-Vis Yellow

ITEM NO.	SIZE	CUFF
6292 1151	Small	Green
6292 11535	Medium	Blue
6292 10545	Large	Tan
6292 10495	X-Large	Gray

No 2XL size.

▶ 6 DOZEN PAIR PER CASE.

DOZEN PAIR
\$136.25

Great White® 3GX™ Gloves

Seamless knit Dyneema® Diamond/lycra glove with polyurethane-coated smooth grip on palm and fingers.

- Glove provides excellent dexterity, tactile sensitivity and cut resistance.
- Great abrasion and puncture resistance and outstanding wet/dry grip.
- Color-coded hems for easy size identification.
- Fully launderable for extended use.



ITEM NO.	SIZE	CUFF HEM
6292 93005	X-Small, 8-1/2"	Purple
6292 93015	Small, 8-9/10"	Red
6292 93025	Medium, 9-3/10"	Yellow
6292 93035	Large, 9-3/5"	Brown
6292 93045	X-Large, 10"	Black
6292 93055	2X-Large, 10-2/5"	Sky Blue

▶ 12 DOZEN PAIR PER CASE.

DOZEN PAIR
\$161.35

NorthFlex Light Task Plus II™ Gloves

Honeywell
NORTH

Highly cut-resistant fiber is 15x stronger than steel on an equal weight basis.

- Polyurethane palm coating is light-weight for maximum comfort and tactile sensitivity.
- Glove conforms to the shape of the wearer's hand for minimal resistance to help reduce hand muscle fatigue.
- Glove fiber is highly cut and abrasion-resistant.
- ANSI cut level 1 and EN388 cut level 2 performance.



ITEM NO.	SIZE
3476 71575	Small, Size 7
3476 71585	Medium, Size 8
3476 71595	Large, Size 9
3476 71605	X-Large, Size 10

▶ 12 DOZEN PAIR PER CASE.

PAIR
\$20.59

Poly/Cotton Knit Gloves with Latex-Coated Palm

WL
Wells Lamont
Industria

Excellent slip-resistance at a great price!

- Latex coating provides a superior grip and is resistant to cuts, abrasions and punctures.
- Poly/Cotton blend is flexible and comfortable.



ITEM NO.	SIZE
4164 02435	Small
4164 02445	Medium
4164 02455	Large
4164 02465	X-Large

▶ 12 DOZEN PAIR PER CASE.

PAIR
\$27.27

G-Tek Cotton/Polyester Gloves with Latex-Coated Crinkle Grip

Latex "crinkle" coating provides superior grip in wet and dry conditions.

- Knit wrist helps prevent dirt and debris from entering the glove.
- Seamless cotton/polyester knit shell is comfortable and flexible.
- Ergonomic shaped curved finger pattern.
- Breathable back for comfort.



ITEM NO.	SIZE
6292 07525	Small
6292 07535	Medium
6292 23145	Large
6292 23155	X-Large
6292 11495	2X-Large

▶ 12 DOZEN PAIR PER CASE.

DOZEN PAIR
\$26.55

SensiLite™ Knit and Dipped Gloves

Designed for jobs that require precise handling of small objects in a dry environment.

- Polyurethane coating offers optimal hand protection in light-weight applications.
- Palm-coated to provide a sure grip and abrasion resistance.
- Seamless elastic nylon liner provides a close yet flexible fit.
- Black coloring for use in environments that present a certain degree of dirt.



ITEM NO.	SIZE	MFR. NO.
2201 05605	Small, Size 7	48-101
2201 05615	Medium, Size 8	48-101
2201 05625	Large, Size 9	48-101
2201 05575	X-Large, Size 10	48-101

▶ 12 DOZEN PAIR PER CASE.

PAIR
\$32.85

Ansell



WARNING:

Some products in this catalog may expose you to chemicals including DEHP Di (2-ethylhexyl) phthalate or BPA (Bisphenol A) which are known to the State of California to cause cancer or birth defects or other reproductive harm. For more information, visit www.P65Warnings.ca.gov.

Leather Palm Industrial Work Gloves

Our finest quality leather palm work glove.

- Leather wrist and thumb shields add protection in vulnerable areas.
- Cotton-lined palm absorbs moisture and prevents chafing.
- Shirred elastic back for better fit. • Gun-cut pattern.



B
Safety Cuff style gloves feature leather strips that add protection for fingertips and knuckles.

▶ 10 DOZEN PAIR PER CASE.

ITEM NO.	PRODUCT	SIZE	DOZEN
6292 41045	A. Knit Cuff	One Size Fits All	\$38.55
6292 16785	B. Safety Cuff	One Size Fits All	37.92

Lined Pigskin Work Gloves

Tough glove for cold or wet work applications.

- Pigskin palm, fingertips and knuckle band becomes softer with use and withstands moisture without stiffening.
- Glove has Thinsulate™, thermosock lining for warmth in cold and wet applications.
- Superior breathability due to the porous texture of the pigskin hide.
- 2-1/2-inch knit wrist.



▶ 12 PAIR PER CASE.

ITEM NO.	PRODUCT	PAIR
3314 19665	One Size Fits All	\$16.45

Grain Leather Drivers Work Gloves

Long-lasting leather for industrial strength protection without the loss of sensitivity.

- Premium grain full leather.
- Straight thumb style, slip-on cuff, shirred elastic back.
- Color-coded hems identify sizes.
- Unlined.



ITEM NO.	SIZE	CUFF HEM	PAIR
6292 28961	Small	Black	▶ 12 PAIR PER CASE. \$12.35
6292 28971	Medium	Green	
6292 28981	Large	Brown	
6292 28991	X-Large	Blue	

Leather Welder's Gloves

Provides heat, flame and spark protection.

- Flame-resistant sleeves.
- Double tanned leather with turned leather hems.
- Absorbent cotton-foam lining.
- Sewn with Kevlar® thread.
- Fully welted with reinforced thumb and palm.



▶ 12 PAIR PER CASE.

ITEM NO.	PRODUCT	PAIR
6292 71501	One Size Fits All	\$14.85

Mig Tig Welding Gloves

- 4-1/2-inch leather gauntlet cuff.
- Top grain cowhide.
- Wing thumb.
- One size fits all.



▶ 12 PAIR PER CASE.

ITEM NO.	PRODUCT	PAIR
6292 02241	Mig Tig Glove	\$24.35

Economy Welding Gloves

- Cotton lining.
- Gray color.
- One size fits all.



▶ 12 PAIR PER CASE.

ITEM NO.	PRODUCT	PAIR
6292 05141	Economy Glove	\$10.05

Jersey Work Gloves

- A. Reversible, 6-ounce pre-shrunk jersey glove with knit wristband.
- B. Heavy 8-ounce jersey glove has separate sewn thumb.
- One size fits all.



▶ 25 DOZEN PAIR PER CASE.

ITEM NO.	PRODUCT	DOZEN PAIR
6292 06065	A. 6 oz. Natural	\$15.55
6292 08085	B. 8 oz. Brown	15.55

Sewn Canvas Work Gloves

Low-cost general purpose hand protection.

- Made from tightly woven cotton canvas.
- Offers protection from abrasion and soil.
- Standard 8-ounce cotton canvas.



Straight sewn thumb, clute pattern back, knit wristband.

▶ 25 DOZEN PAIR PER CASE.

ITEM NO.	PRODUCT	DOZEN PAIR
6292 39085	Sewn Canvas Work Gloves	\$12.25

Chore Canvas Work Gloves

- Two layers of canvas material quilted on palms for increased protection and comfort.
- Absorbent gold fleece palm.
- Full chore style with knit wrist.
- One size fits all.
- 16 ounce.

▶ 25 DOZEN PAIR PER CASE.

ITEM NO.	PRODUCT	DOZEN PAIR
6292 05685	Chore Gloves	\$40.05



Knit Gloves with Grip-Enhancing PVC Coating



- Provides a sure grip, superb fit, flexibility and comfort even after repeated machine laundering.
- Pattern covers both the front and back, making each glove reversible.
- Comfortable, seamless construction.



ITEM NO.	SIZE
3314 97615	Small
3314 97625	Medium
3314 97635	Large
3314 97645	X-Large

▶ 12 DOZEN PAIR PER CASE.

DOZEN PAIR
\$20.45

String Knit PVC-Coated Gloves



Black PVC coating on palm and fingers improves grip and provides abrasion-resistance.

- Natural color, cotton/polyester blend.
- 7-gauge regular-weight knit gloves.
- Superior ventilation and comfort.

PVC-coated palm for enhanced grip.



ITEM NO.	SIZE
3314 96705	Small
3314 96725	Large

▶ 12 DOZEN PAIR PER CASE.

DOZEN PAIR
\$16.65

Single/Double-Dot Gloves

PVC dots provide better grip and abrasion-resistance for longer wear.

- Seamless knit shell is comfortable and flexible.
- Double-dot glove is reversible, fits either hand.
- Coated finger tips extend glove life, increase abrasion resistance and durability in a high-wear area.
- Knit cuff helps prevent dirt and debris from entering the glove.
- 50/50 cotton/acrylic blend.
- Machine washable.
- One size fits all.



▶ 25 DOZEN PAIR PER CASE.

ITEM NO.	PRODUCT	DOZEN PAIR
6292 05885	A. Single-Dot	\$18.25
6292 03305	B. Double-Dot	16.95



WARNING:

Some products in this catalog may expose you to chemicals including DEHP Di (2-ethylhexyl) phthalate or BPA (Bisphenol A) which are known to the State of California to cause cancer or birth defects or other reproductive harm. For more information, visit www.P65Warnings.ca.gov.

Knit Eco-Gloves®

Go 'green' with Eco-Gloves® — made from recycled post-consumer plastics.



- Using EarthSPUN™ green-certified technology, recycled plastic bottles are processed into fibers that are used to create Eco-Gloves®.
- Recycled fibers shrink less than normal gloves, extending life of glove.
- Stain-resistant. • One size. • Machine-knitted wrist.



Made from recycled plastic bottles.



▶ 40 DOZEN PAIR PER CASE.

ITEM NO.	PRODUCT	DOZEN PAIR
7419 70075	Gray	\$11.45

Thermal Knit Insulating Gloves

Ideal as a liner in processing areas or for cold environments.

- Hollow-core fiber insulates and wicks perspiration.
- Machine washable without shrinkage.
- Reversible. • Available in white or blue.
- One size fits all.



▶ 40 DOZEN PAIR PER CASE.

ITEM NO.	PRODUCT	DOZEN PAIR
7419 10135	White	\$23.05

▶ 24 DOZEN PAIR PER CASE.

ITEM NO.	PRODUCT	DOZEN PAIR
7419 20145	Blue	\$34.55

Rag Wool Gloves

- 70% wool/30% acrylic.
- Reversible and seamless.
- Use alone or as a liner under a heavy-duty freezer glove.
- One size fits all.
- Color: olive.



▶ 12 DOZEN PAIR PER CASE.

ITEM NO.	PRODUCT	DOZEN PAIR
3463 37005	Rag Wool Gloves	\$38.10

Heavy-Weight Cotton/Poly String Knit Gloves

- For high-volume consumption and frequent replacement.
- Economy weight blend of cotton/poly.
- Gray color hides dirt for longer wear.
- Made from component materials which comply with Federal regulations for food contact. 21 CFR, 170-199.
- 65% cotton, 35% polyester.



▶ 25 DOZEN PAIR PER CASE.

ITEM NO.	PRODUCT	DOZEN PAIR
6292 1385	One Size Fits All	\$11.75

Tight-Knit Gloves

Perfect for use as a glove liner.

- Tight, 13 threads per inch knit increases both dexterity and sensitivity.
- Poly/cotton blend.
- One size fits all.
- Machine washable.
- Sewn wristband.



▶ 30 DOZEN PAIR PER CASE.

ITEM NO.	PRODUCT	DOZEN PAIR
3140 01315	Tight-Knit Gloves	\$15.23

Honeywell

Knit Gloves

- Poly/cotton blend knitted gloves.
- Bleached and unbleached with sewn wrist bands.
- Color-coded cuff edges designates glove weight.
- Ambidextrous and machine washable.
- One Size Fits All

Light-Weight Knit Gloves

Natural with white cuff edge.

22 GRAMS

▶ 12 PAIR PER PACK - 40 PACKS PER CASE.

ITEM NO.	PRODUCT	DOZEN PAIR
E542 03725	Light-Weight Glove	\$5.90



Medium-Weight Knit Gloves

Natural with blue cuff edge.

24 GRAMS

▶ 12 PAIR PER PACK - 40 PACKS PER CASE.

ITEM NO.	PRODUCT	DOZEN PAIR
E542 03615	Medium-Weight Glove	\$7.00



Medium-Weight Knit Gloves

White with green cuff edge.

28 GRAMS

▶ 12 PAIR PER PACK - 40 PACKS PER CASE.

ITEM NO.	PRODUCT	DOZEN PAIR
E542 03745	Medium-Weight Glove	\$8.00



Heavy-Weight Knit Gloves

White with gold cuff edge.

38 GRAMS

▶ 12 PAIR PER PACK - 24 PACKS PER CASE.

ITEM NO.	PRODUCT	DOZEN PAIR
E542 03735	Heavy-Weight Glove	\$15.25



OUR LOWEST COST COTTON KNIT GLOVE!
Available By the Case Only.

Economy Knit Gloves with Blue Cuff Edge

18 GRAMS

▶ 40 DOZEN PAIR PER CASE.

ITEM NO.	PRODUCT	CASE
E542 0371	Economy Glove	\$210.05

Women's Knit Gloves

Smaller sized to fit better.

- Poly/cotton blend.
- Sewn wristband.
- Reversible and machine washable.
- White with light blue cuff edge.
- One size fits all.



18 GRAMS

or

34 GRAMS



▶ 12 PAIR PER PACK - 40 DOZEN PAIR PER CASE.

ITEM NO.	PRODUCT	DOZEN PAIR
E542 51045	Standard-Weight	\$9.20
E542 51055	Heavy-Weight	9.30

Shrink-Resistant Poly/Cotton Knit Gloves

Test washed and dried 20 times with less than 10% shrinkage.

- White with gray cuff edge.
- Custom poly/cotton blend.
- Sewn wristband.

40 GRAMS

▶ 12 PAIR PER PACK - 16 PACKS PER CASE.

ITEM NO.	PRODUCT	DOZEN PAIR
E542 51015	Shrink-Resistant Glove	\$10.35



Kut Gard® Knit Gloves with Kevlar®

A2

Two-ply knit gloves with Kevlar® protect hands from minor cuts and abrasions.

- Dupont Kevlar® fiber construction provides high tensile strength relative to its weight, is inherently cut resistant and will not melt, ignite or conduct electricity.
- Knit wrist helps prevent dirt and debris from entering the glove.
- Reversible design allows replacing one glove at a time, rather than pairs.
- Can be used as gloves or glove liners.
- Color coded hems for easy size identification.
- Glove color: yellow.



ITEM NO.	SIZE	WRISTBAND
6292 03015	Medium	Red
6292 03025	Large	Yellow
6292 03035	X-Large	Green

▶ 12 DOZEN PAIR PER CASE.

DOZEN PAIR
\$91.98

Low-Cost Cotton Lisle Inspector's Gloves

- Reversible gloves absorb body oils and prevent damage to product from contact with skin.
- Ideal glove liners.
- Unhemmed.



▶ 100 DOZEN PAIR PER CASE.

ITEM NO.	PRODUCT	DOZEN PAIR
6292 25005	One Size Fits All	\$7.95

CleanTeam® Nylon Inspector's Gloves

- Reversible lint-free inspector's gloves are made of 40-denier nylon tricot.
- Nylon fabric absorbs perspiration.
- Cotton color binding denotes size.
- Rolled sewn hem.



ITEM NO.	SIZE	WRISTBAND
6292 50635	Small	Yellow
6292 50645	Medium	Red
6292 95275	Large	Green
6292 64465	X-Large	White
6292 64475	2X-Large	Brown

▶ 100 DOZEN PAIR PER CASE.

DOZEN PAIR
\$11.75

NEED ASSISTANCE?

Our experienced customer service representatives are available to answer your questions, find the products you are looking for, check product availability, as well as take your order.

800-456-5624

CleanTeam® Cut and Sewn Nylon Inspector's Gloves

Stretch nylon fabric gloves are the economical choice for low-lint hand and product protection.

- Nylon fabric absorbs perspiration and keeps hand comfortable.
- Can be used as liners under disposable and unsupported liquid proof gloves.
- Zigzag stitched rolled hem.



Cut and sewn for added durability.

▶ 50 DOZEN PAIR PER CASE.

ITEM NO.	SIZE	WRISTBAND	DOZEN PAIR
6292 05865	Men's, 10 Large	Blue	\$21.45
6292 05855	Women's, 8-1/2 Medium	Red	21.15

Black Jack® 14-Inch Premium Multi-Dipped Neoprene Gloves

Fully-coated etched rough finish for superior grip.

- 100% cotton brushed interlock lining for extra comfort and absorption.
- Ergonomically designed allowing less hand fatigue.
- Liquid-proof.
- Provides protection against abrasions, cuts, acids, caustics and other hazardous chemicals.
- Treated with Actifresh® to help retard odors and eliminate germs by controlling bacterial build-up.

▶ 12 PAIR PER CASE.

ITEM NO.	PRODUCT	PAIR
3314 14181	One Size Fits All	\$26.15



Etched rough finish for superior grip.

TECHNIC® NS-450 Black Neoprene/Latex Gloves

16-inch gauntlet provides full forearm protection.

- One layer of heavy-duty neoprene over two layers of natural latex.
- Resistant to a broad range of oils and chemicals.
- Natural curved design fits hand easily and comfortably.

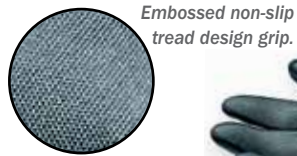

Embossed non-slip tread design grip.



Cotton flock lining



NOTE: Natural rubber latex may cause allergic reactions in some individuals.

ITEM NO.	PRODUCT	DOZEN PAIR
7975 09015	Medium	▶ 12 PAIR PER POLY BAG - 6 BAGS PER CASE. \$82.85
7975 09025	Large	
7975 09035	X-Large	

Neox® Heavy-Duty Neoprene Coated Gloves



Resistant to oils, acids, caustics, alcohol and solvents.

- Neoprene coating resists abrasions, punctures, tears and a broad range of chemicals.
- Curved fingers and 2-piece lining for a comfortable fit.
- Smooth coated finish grip.
- 18-inch gauntlet cuff.

▶ 36 PAIR PER CASE.

ITEM NO.	PRODUCT	MRF. NO.	PAIR
2201 00171	One Size Fits All	09-928	\$26.82



SHOWA 3415 Neoprene Gloves

Withstands complete submersion in chemicals.

- Rough textured finish for a superb grip in wet conditions.
- Neoprene-coated and bonded to a seamless knit liner.
- Light-weight and dexterous as an unsupported glove.
- Launderable, durable and abrasion-resistant.
- 14-inch gauntlet.
- Size: 10.



Foam sponge-like grip.

▶ 12 PAIR PER POLY BAG - 6 BAGS PER CASE.

ITEM NO.	SIZE	DOZEN PAIR
3841 0577	X-Large	\$79.95

SHOWA 6781R Neoprene Gloves

For protection against acids, caustics, oils, greases and many solvents.

- Multi-dipped in premium grade neoprene for superior quality and durability.
- Rough finish for a superb grip in wet conditions.
- 12-inch gauntlet.



Soft cotton liner absorbs perspiration and makes it easy to pull on and off.



▶ 3 DOZEN PAIR PER CASE.

ITEM NO.	SIZE	DOZEN PAIR
3841 67815	Large	\$149.95

AFR-282 Nitrile Over Latex Gloves

The improved chemical, fat and acid resistance of nitrile with the comfort of latex.

- Cotton flock lining adds comfort and absorbs perspiration.
- 13-inch gauntlet.
- Color: blue/green.

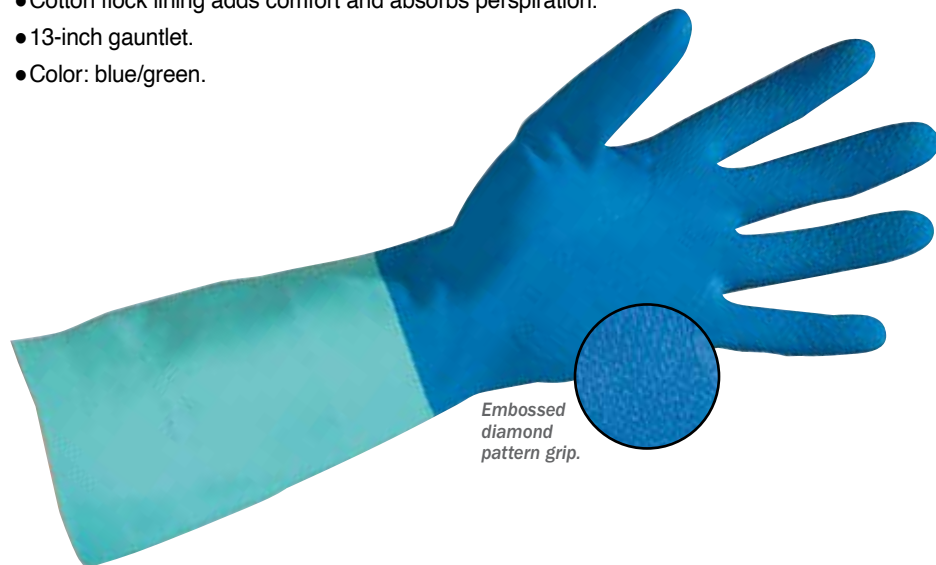

Embossed diamond pattern grip.

MAPA
PROFESSIONAL



Flock lining.

ITEM NO.	SIZE
7975 06375	Small
7975 06385	Medium
7975 06395	Large
7975 06405	X-Large
7975 06415	2X-Large

▶ 6 DOZEN PAIR PER CASE.

DOZEN PAIR
\$26.45

NOTE: Natural rubber latex may cause allergic reactions in some individuals.

Chemi-Pro® Neoprene Over Latex Gloves

Increased protection against chemicals.

- 27 mil for extra ruggedness and durability.
- Diamond-embossed pattern grip.
- 13-inch pinked cuff.

Ansell



Embossed diamond pattern grip.

ITEM NO.	SIZE	MFR. NO.
2201 24075	Size 7	87-224
2201 24085	Size 8	87-224
2201 24095	Size 9	87-224
2201 24105	Size 10	87-224

▶ 12 PAIR PER PACK - 12 PACKS PER CASE.

DOZEN PAIR
\$39.80

Omni® Neoprene/Latex Blend Gloves

20 mil with 100% cotton flocking.

- Unique neoprene and natural latex blend provides excellent chemical, tear, puncture and abrasion-resistance.
- 12-inch pinked cuff.

Ansell



Pebble embossed for added grip.

ITEM NO.	SIZE	MFR. NO.
2201 27605	Small, Size 7	87-276
2201 27685	Medium, Size 8	87-276
2201 27695	Large, Size 9	87-276
2201 27615	X-Large, Size 10	87-276

▶ 12 PAIR PER PACK - 12 PACKS PER CASE.

DOZEN PAIR
\$29.44

SHOWA Rubber-Coated Gloves



Heavy rubber coating protects hands while loading the skinning machine.

- Soft cotton lining with multiple coatings of natural rubber for superior cut, puncture and abrasion resistance.
- Chemically-treated glove interior remains fresh and comfortable.
- Wrinkle texture enhances wet and dry gripping ability.
- One size fits all.



▶ 6 DOZEN PAIR PER CASE.

ITEM NO.	PRODUCT	DOZEN PAIR
3841 44585 A.	10" Gauntlet	\$81.85
3841 00655	12" Gauntlet	91.65

▶ 3 DOZEN PAIR PER CASE.

ITEM NO.	PRODUCT	DOZEN PAIR
3841 00675 B.	14" Gauntlet	\$113.75

13-Inch Skinner Gloves

Designed for meat and poultry skinner machine operators.

- Fully dipped latex glove features a unique crinkle finish that increases overall grip in wet and dry conditions.
- Jersey cotton liner is napped for added warmth and comfort.
- 6-inch gauntlet offers extended forearm protection.

Crinkle texture provides exceptional grip.



ITEM NO.	SIZE
7419 22495	Size 8
7419 22505	Size 9
7419 22515	Size 10
7419 22525	Size 11

▶ 6 DOZEN PAIR PER CASE.

DOZEN PAIR
\$97.25

NOTE: Natural rubber latex may cause allergic reactions in some individuals.

Golden Grab-It® II 12-Inch Skinner Gloves



- Premium-grade natural rubber latex crinkle finish coating offers exceptional cut resistance and long service life.
- Soft knit jersey lining provides superior comfort and flexibility.
- Cut resistant and comfortable.
- Gauntlet: 12 inches. • Available in size 10 only.



Soft cotton lining absorbs perspiration and makes gloves easy to put on and take off.



▶ 6 DOZEN PAIR PER CASE.

ITEM NO.	PRODUCT	MRF. NO.	DOZEN PAIR
2201 89055	Size 10.	16-612	\$118.68

Edge® Rubber-Coated Gloves



Natural rubber latex glove made to handle abrasive or sharp-edged materials.



- Soft knit jersey lining provides superior comfort and flexibility.
- Safety cuff to help protect hand and wrist from injury.
- Rough finish for excellent wet or dry use.
- FDA-compliant materials.
- Available in size 10 only.



▶ 6 DOZEN PAIR PER CASE.

ITEM NO.	PRODUCT	MRF. NO.	DOZEN PAIR
2201 47105	Size 10.	16-347	\$80.04

WorkHorse® 12-Inch, Blue Latex Reusable Gloves, 13 Mil

- Anatomically shaped for comfort.
- Beaded cuff to improve tear-resistance.
- Anti-slip honeycomb grip.
- Natural rubber.



Honeycomb grip.

ITEM NO.	SIZE
E542 11355	Size 7
E542 11365	Size 8
E542 11375	Size 9
E542 11385	Size 10
E542 11395	Size 11

▶ 12 PAIR PER PACK - 12 PACKS PER CASE.

PACK
\$11.95

NOTE: Natural rubber latex may cause allergic reactions in some individuals.

Economy Latex Rubber Gloves

Latex gloves provide good protection from chemicals, punctures, abrasions and cuts. Ideal for poultry processing and canning.

- Natural rubber allows excellent dexterity, tensile strength and elasticity.
- 12 inch length for protection against chemical hazards.
- Pinked cuff.
- Made from component materials which comply with FDA regulations for food contact 21CFR 177-2600.
- Choose from amber or blue color.



Pebble grip.



13 Mil Pebble Grip

Mfr. No. 390T

ITEM NO.	SIZE
2201 04765	Size 7
2201 04785	Size 8
2201 04805	Size 9
2201 14895	Size 10
2201 14905	Size 11

PACK
\$18.19

Fish scale grip.



20 Mil Fish Scale Grip

Mfr. No. 394

ITEM NO.	SIZE
2201 94075	Size 7
2201 94085	Size 8
2201 94095	Size 9
2201 94105	Size 10

PACK
\$18.39

Fish scale grip.

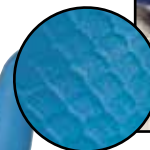

13 Mil

Mfr. No. 356T

ITEM NO.	SIZE
2201 35775	Size 7
2201 35785	Size 8
2201 35795	Size 9
2201 35805	Size 10
2201 35815	Size 11

PACK
\$11.45

17 Mil

Mfr. No. 356

ITEM NO.	SIZE
2201 56075	Size 7
2201 56085	Size 8
2201 56095	Size 9
2201 56105	Size 10
2201 56115	Size 11

PACK
\$13.11

▶ 12 PAIR PER PACK - 12 PACKS PER CASE.

▶ 12 PAIR PER PACK - 12 PACKS PER CASE.

Assurance® 18 Mil Flock-Lined Natural Rubber Latex Gloves

- Superior comfort and dexterity for light duty protection.
- Cotton flock lining absorbs perspiration.
- Pinked cuff. • Length: 12 inches.

Honeycomb grip.

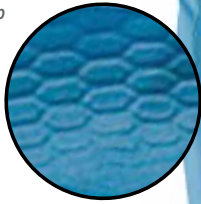

ITEM NO.	SIZE
6292 04005	Small, Size 7
6292 03995	Medium, Size 8
6292 03985	Large, Size 9
6292 04015	X-Large, Size 10

▶ 12 PAIR PER PACK - 12 PACKS PER CASE.

PACK
\$26.15

17 Mil Latex, Lightly-Flocked Rubber Gloves

Ansell

- Color: yellow.
- Rolled cuff.
- Length: 12 inches.

Raised diamond grip.

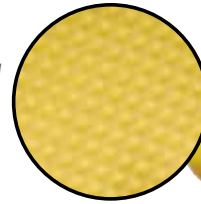

ITEM NO.	SIZE
7500 57305	Medium, Size 8
7500 57405	Large, Size 9
7500 57505	X-Large, Size 10

▶ 12 PAIR PER PACK - 12 PACKS PER CASE.

PACK
\$10.53

29 Mil Latex Rubber Gloves

Palm is 50% thicker than most standard flock-lined gloves.

- Durable latex can be worn for longer periods between replacement.
- 100% cotton flock lining for increased comfort.
- Pinked cuff.
- 13-inch gauntlet.

Diamond grip.

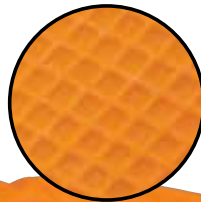

▶ 12 PAIR PER PACK - 12 PACKS PER CASE.

ITEM NO.	SIZE	MRF. NO.	PACK
2201 08105	X-Large, Size 10	87-208	\$45.23

SHOP 24/7

bunzlpd.com



CHAT

Need Help?
Chat With Us
Online!

STAY CONNECTED WITH US:







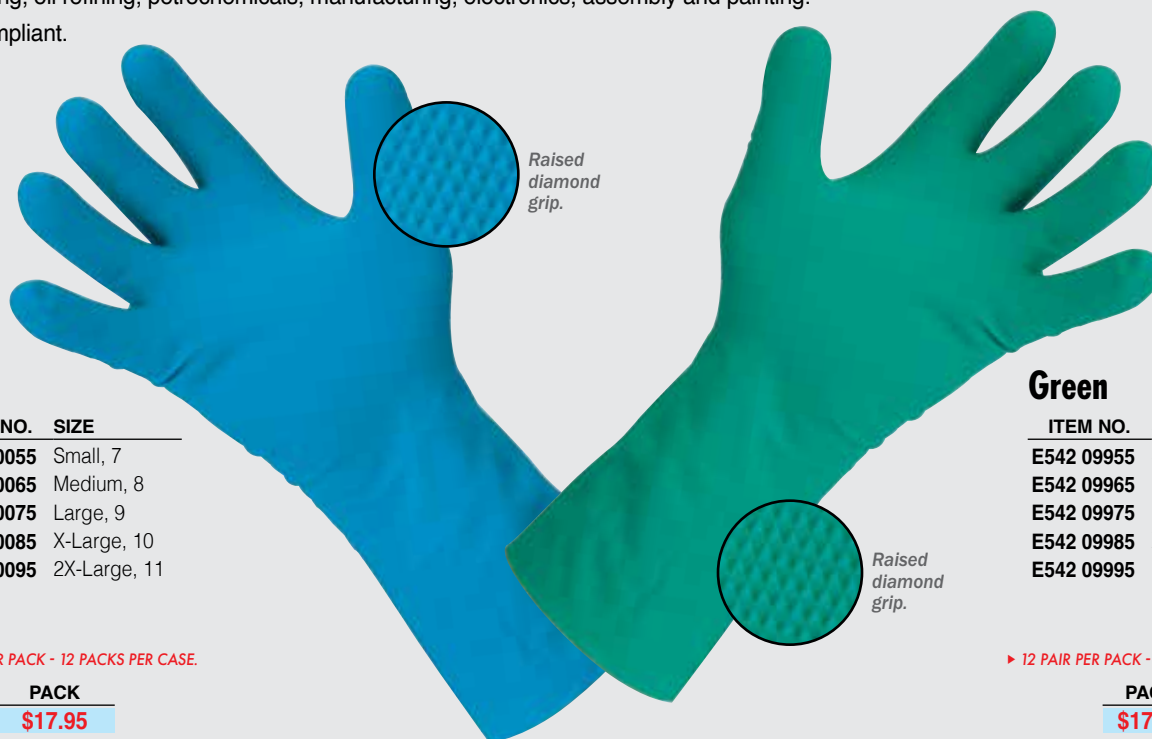

WorkHorse® 11 Mil Unlined, 13-Inch Straight Cuff Nitrile Gloves

- Chlorinated for ease of donning and doffing. • Lint-free and reusable.
- Fingertip precision with high dexterity.
- Applications: food processing — red meat, vegetables, fruit, dairy and canning, degreasing, chemical processing, oil refining, petrochemicals, manufacturing, electronics, assembly and painting.
- FDA-compliant.



Blue

ITEM NO.	SIZE
E542 10055	Small, 7
E542 10065	Medium, 8
E542 10075	Large, 9
E542 10085	X-Large, 10
E542 10095	2X-Large, 11

▶ 12 PAIR PER PACK - 12 PACKS PER CASE.

PACK
\$17.95

Green

ITEM NO.	SIZE
E542 09955	Small, 7
E542 09965	Medium, 8
E542 09975	Large, 9
E542 09985	X-Large, 10
E542 09995	2X-Large, 11

▶ 12 PAIR PER PACK - 12 PACKS PER CASE.

PACK
\$17.95

FREE GROUND SHIPPING
when you place an order for \$500 or more from **THIS BUYERS GUIDE!**

*FREE SHIPPING does NOT include UPS Next Day Air, UPS 2nd Day or UPS 3rd Day Select. Certain items may not qualify.

This offer is good only on orders shipped UPS Ground in the 48 contiguous states. Based on dimensional weight, we will determine the most efficient means of shipment, either UPS or LTL. Products may ship by truckline.

15 Mil Flock-Lined, 13-Inch Straight Cuff Nitrile Gloves

- Soft, cotton flocked lining absorbs perspiration.
- Makes removal easier.
- ANSI cut level 4.

Ansell

LATEX FREE

A4

ITEM NO.	SIZE	MFR. NO.
2201 75075	Size 7 . . .	37-175
2201 75085	Size 8 . . .	37-175
2201 75095	Size 9 . . .	37-175
2201 75105	Size 10 . . .	37-175
2201 75115	Size 11 . . .	37-175

▶ 12 PAIR PER PACK - 12 PACKS PER CASE.

PACK
\$27.57



Unlined Nitrile Gloves

- Made from component materials which comply with FDA regulations for food contact 21CFR 177.2600.
- Offers versatile protection against chemicals and oils.
- Sand patch grip pattern on palm and fingertips.
- Latex-free. • Straight cuff.

Ansell

LATEX FREE



Sand patch grip.



11 Mil, 13 Inch 37-145

ITEM NO.	SIZE
2201 45075	Small, 7
2201 45085	Medium, 8
2201 45095	Large, 9
2201 45105	X-Large, 10
2201 45115	2X-Large, 11

▶ 12 PAIR PER PACK - 12 PACKS PER CASE.

PACK
\$24.21

22 Mil, 15 Inch 37-165

ITEM NO.	SIZE
2201 16575	Small, 7
2201 16585	Medium, 8
2201 16595	Large, 9
2201 65105	X-Large, 10
2201 65115	2X-Large, 11

▶ 12 PAIR PER PACK - 12 PACKS PER CASE.

PACK
\$94.07

15 Mil, 13 Inch 37-155

ITEM NO.	SIZE
2201 55075	Small, 7
2201 55085	Medium, 8
2201 55095	Large, 9
2201 55105	X-Large, 10
2201 55115	2X-Large, 11

▶ 12 PAIR PER PACK - 12 PACKS PER CASE.

PACK
\$28.66

22 Mil, 18 Inch 37-185

ITEM NO.	SIZE
2201 8507	Small, 7
2201 8508	Medium, 8
2201 8509	Large, 9
2201 8510	X-Large, 10
2201 8511	2X-Large, 11

▶ 12 PAIR PER PACK - 12 PACKS PER CASE.

PACK
\$137.93

BUY IN BULK & SAVE!

Bulk Pak, 11 Mil, 13 Inch

37-145

ITEM NO.	SIZE
2201 4807	Small, 7
2201 4808	Medium, 8
2201 4809	Large, 9
2201 4810	X-Large, 10
2201 4811	2X-Large, 11

▶ 6 DOZEN PAIR PER CASE.

CASE
\$137.19

Rack 'Em™ Glove Rack

Organize, dry and store your gloves in one place, ready to wear.

- Rust-resistant black PVC coating over heavy-duty galvanized steel.
- Allows for quicker drying time.
- Screws supplied for 16 inch on center holes.
- Holds four pairs. • Height: 14 inches.

RACK'EM



ITEM NO.	PRODUCT	EACH
3446 20441	Glove Rack	\$52.95

NOTE: Gloves sold separately.



THE BENCHMARK IN DISPOSABLE NITRILE GLOVES



Nitrile Disposable Gloves

Flexibility with color coding compliance.

- 5 mil at the palm.
- Powder-free.

650 SERIES

LATEX FREE

BUNZL EXCLUSIVE
PROCESSOR DIVISION



Orange

ITEM NO.	SIZE
E542 02555	Small
E542 02565	Medium
E542 02575	Large
E542 02585	X-Large
E542 02595	2X-Large

▶ 100 PER BOX -
10 BOXES PER CASE -
50 CASES/PALLET

BOX
\$11.95



Grape

ITEM NO.	SIZE
E542 02455	Small
E542 02465	Medium
E542 02475	Large
E542 02485	X-Large
E542 02495	2X-Large

▶ 100 PER BOX -
10 BOXES PER CASE -
50 CASES/PALLET

BOX
\$11.95



Lime Green

ITEM NO.	SIZE
E542 02655	Small
E542 02665	Medium
E542 02675	Large
E542 02685	X-Large
E542 02695	2X-Large

▶ 100 PER BOX -
10 BOXES PER CASE -
50 CASES/PALLET

BOX
\$11.95



Black

ITEM NO.	SIZE
E542 02755	Small
E542 02765	Medium
E542 02775	Large
E542 02785	X-Large
E542 02795	2X-Large

▶ 100 PER BOX -
10 BOXES PER CASE -
50 CASES/PALLET

BOX
\$11.95



Green

ITEM NO.	SIZE
E542 04215	Small
E542 04225	Medium
E542 04235	Large
E542 04245	X-Large
E542 04255	2X-Large

▶ 100 PER BOX -
10 BOXES PER CASE -
50 CASES/PALLET

BOX
\$11.95



Blue

ITEM NO.	SIZE
E542 04115	Small
E542 04125	Medium
E542 04135	Large
E542 04145	X-Large
E542 04155	2X-Large

▶ 100 PER BOX -
10 BOXES PER CASE -
50 CASES/PALLET

BOX
\$11.95

Nitrile Disposable Gloves

Protection against animal fats, oil-based solvents, petroleum and caustics with strength, puncture-resistance and color-coding compliance.

- Fingertip texture improves grip without sacrificing dexterity.
- Length: 9 inches. • Ambidextrous. 3.5 mil at the palm.

Powder-Free

Blue

ITEM NO.	SIZE
E542 04265	Small
E542 04275	Medium
E542 04285	Large
E542 04295	X-Large
E542 04305	2X-Large

▶ 100 PER BOX - 10 BOXES PER CASE - 50 CASES PER PALLET.

BOX
\$9.95



450 SERIES



LATEX FREE



Call 800-456-5624 Or Visit WWW.BUNZLPD.COM For Current Pricing

8 Mil Nitrile Disposable Gloves

Offers protection equal to reusable nitrile gloves that are nearly twice as thick.

- Patented construction maximizes comfort and minimizes hand fatigue.
- Ambidextrous. • 9-1/2-inch glove with cuff.

Powdered

ITEM NO.	SIZE
3841 80035	Small, Size 7
3841 80045	Medium, Size 8
3841 80055	Large, Size 9
3841 80065	X-Large, Size 10

Powder-Free

ITEM NO.	SIZE
3841 18055	Small, Size 7
3841 18065	Medium, Size 8
3841 18075	Large, Size 9
3841 18085	X-Large, Size 10

▶ 50 PER BOX - 20 BOXES PER CASE.

BOX
\$29.65



LATEX FREE

Natural Latex Finger Cots

- Can be used to protect fingers from contamination and infection during applications.
- Ideal for covering up bandages. • Length: 2-3/4 inches.
- 3 mil. • Color: white. • Powder-free. • Rolled.
- Anti-static. • Disposable.

NOTE: Natural rubber latex may cause allergic reactions in some individuals.

ITEM NO.	SIZE
3140 00845	Small, Size 1
3140 00855	Medium, Size 2
3140 00775	Large, Size 3
3140 00765	X-Large, Size 4

▶ 720 PER BAG.

BAG
\$42.91

Honeywell

NORTH



WARNING:

Some products in this catalog may expose you to chemicals including DEHP Di (2-ethylhexyl) phthalate or BPA (Bisphenol A) which are known to the State of California to cause cancer or birth defects or other reproductive harm. For more information, visit www.P65Warnings.ca.gov.

SHOWA 1005 Green 5 Mil Latex Disposable Gloves

Superior dexterity and grip while combining the strength and resistance of 100% natural rubber latex.

- Natural rubber compound is more sensitive and less susceptible to tearing than similar gauge gloves.
- Provides a great grip in wet or dry conditions.
- Lightly powdered.
- Length: 9-1/2 inches, rolled cuff.



ITEM NO.	SIZE
3841 13045	Small, Size 6-7
3841 13055	Medium, Size 7-8
3841 13065	Large, Size 8-9

▶ 100 PER BOX - 20 BOXES PER CASE.

BOX
\$32.95

5 Mil Latex Disposable Gloves

High quality, single-use gloves.

- Available in powdered or powder-free styles.
- Length: 9 inches, rolled cuff.
- Color: natural.
- Ambidextrous.



Powdered

ITEM NO.	SIZE
7500 51205	Small
7500 51405	Large
7500 51505	X-Large

Powder-Free

ITEM NO.	SIZE
7500 52205	Small
7500 52305	Medium
7500 52405	Large
7500 52505	X-Large

▶ 100 PER BOX - 10 BOXES PER CASE.

BOX
\$17.45

Call 800-456-5624 Or Visit WWW.BUNZLPD.COM For Current Pricing

Wrist-Length, Poly Disposable Gloves

- Made of clear polyethylene. • Embossed all-over texture.

ITEM NO.	SIZE
7500 71205	Small, Size 7
7500 71305	Medium, Size 8
7500 71405	Large, Size 9

▶ 1,000 PER BOX - 10 BOXES PER CASE.

BOX
\$21.83



Embossed texture.



Shoulder-Length, Poly Disposable Gloves

- Made of 1.5 mil poly film. • Ambidextrous.
- Length: 34 inches. • Color: white.

▶ 100 PER BOX - 10 BOXES PER CASE.

ITEM NO.	SIZE	BOX
3439 04885	One Size Fits All	\$14.95



5 Mil Vinyl Disposable Gloves

Increased sensitivity and stretch-to-fit without restriction of blood flow. 10 inch length fits either hand.



Clear

Powdered

ITEM NO.	SIZE
E542 03815	Small
E542 03825	Medium
E542 03835	Large
E542 03845	X-Large
E542 03855	2X-Large

Blue

Powdered

ITEM NO.	SIZE
E542 03965	Small
E542 03975	Medium
E542 03985	Large
E542 03995	X-Large
E542 04005	2X-Large



▶ 100 PER BOX - 10 BOXES PER CASE.

BOX

\$6.95

Clear

Powder - Free

ITEM NO.	SIZE
E542 03865	Small
E542 03875	Medium
E542 03885	Large
E542 03895	X-Large
E542 03955	2X-Large

Blue

Powder - Free

ITEM NO.	SIZE
E542 04015	Small
E542 04025	Medium
E542 04035	Large
E542 04045	X-Large

▶ 100 PER BOX - 10 BOXES PER CASE.

BOX

\$6.95

Neoprene Reusable Sleeves

- Heavy-duty, 16 mil thickness.
- Cut-resistant and waterproof neoprene on nylon.
- Sewn overlock with enclosed elastic at each end.



▶ 12 PER PACK.

ITEM NO.	SIZE	COLOR	PACK
4804 20185	18"	Yellow	\$77.15

Iron Eagle® 18-Inch Polyurethane Reusable Sleeves

TINGLEY
est. 1896

- Polyurethane coating on 200 denier nylon.
- Light-weight, flexible and abrasion-resistant.
- Sewn elastic cuffs. • 5.5 ounces.



ITEM NO.	SIZE	COLOR	PAIR
4059 16731	18"	Gold	\$6.80

18-Inch Heavy-Duty Reusable Neoprene Sleeves

- Resistant to chemicals.
- 18 mil thickness.

▶ 100 PAIR PER CASE.

ITEM NO.	COLOR	PAIR
7724 0013	White	\$9.54
7724 0015	Yellow	9.54



Heavy-duty, reinforced elastic cuff opening.



18-Inch VR™ Vinyl Replacement Sleeves



- Superior strength and can be recycled.
- Will not become brittle even after multiple uses.
- Material becomes softer after each use.
- Easy-to-clean and reuse.



▶ 150 SLEEVES PER CASE.

▶ 150 SLEEVES PER CASE.

4 Mil Sleeves

ITEM NO.	COLOR	CASE
3386 4352	Clear	\$171.67
3386 3758	Blue	171.67
3386 4350	White	171.67
3386 4351	Yellow	171.67

6 Mil Sleeves

ITEM NO.	COLOR	CASE
3386 3759	Blue	\$184.63
3386 4353	White	184.63
3386 4354	Yellow	184.63

18-Inch Vinyl Processing Sleeves

- Heat-sealed with enclosed elastic at each end.



▶ 12 DOZEN PAIR PER CASE.

ITEM NO.	SIZE	COLOR	THICKNESS	DOZEN PAIR
7500 70645	18"	Clear	4 Mil	\$13.95
7500 70715	18"	Blue	6 Mil	14.50
7500 70815	18"	Blue	8 Mil	14.95
7500 70845	18"	Clear	8 Mil	14.95
7500 70825	18"	White	8 Mil	14.95

Polyurethane-Coated Reusable Sleeves

- Light-weight rip-stop fabric.
- Heat-sealed with enclosed elastic at each end.



▶ 12 PAIR PER PACK.

ITEM NO.	SIZE	COLOR	PACK
4804 10185	18"	Yellow	\$50.75

WorkHorse® Polyethylene Disposable Sleeves



- Low-cost waterproof protection for light-duty, limited-use applications.



Standard 1 Mil Sleeves

▶ 2,000 PER CASE.

ITEM NO.	SIZE	COLOR	CASE
E542 0501	16"	Blue	\$120.58
E542 0499	16"	White	120.58
E542 0496	18"	Blue	126.62
E542 0500	18"	White	126.62

Heavy-Duty 1.5 Mil Sleeves

▶ 100 SLEEVES PER BOX — 10 BOXES PER CASE.

ITEM NO.	SIZE	COLOR	CASE
E542 0789	18"	Clear	\$106.30
E542 0790	18"	Blue	106.30

WorkHorse® PolyPro Coated Sleeves



- Water-resistant polypropylene-coated fabric.
- Offers protection against dry particulates and light liquid sprays.
- Tapered.



▶ 200 SLEEVES PER CASE.

ITEM NO.	SIZE	COLOR	CASE
E542 0898	18"	White	\$84.74



WARNING:

Some products in this catalog may expose you to chemicals including DEHP Di (2-ethylhexyl) phthalate or BPA (Bisphenol A) which are known to the State of California to cause cancer or birth defects or other reproductive harm. For more information, visit www.P65Warnings.ca.gov.

REUSABLE AND DISPOSABLE SLEEVES



Stainless Steel, Disposable Glove Dispensers

Electropolished finish to enhance corrosion resistance, improve surface finish and ease of cleaning.

- Available in 1-box, 2-box or 3-box sizes.
- Stainless steel construction can be easily washed down without rusting.
- Easily mounts to wall (mounting hardware not included).
- Gloves and boxes not included.

ITEM NO.	PRODUCT	DIMENSIONS	EACH
3013 2021	A. 1-Box Dispenser	5-1/2" x 3-1/2" x 10-1/2"	\$70.45
3013 2023	B. 2-Box Dispenser	10" x 3-1/2" x 11-3/4"	80.85
3013 2022	C. 3-Box Dispenser	10-1/4" x 3-1/2" x 17"	97.05

Rack'Em™ Disposable Glove Box Dispenser Racks

- Shelves organize gloves for quick and easy access. • Holds all gloves on one convenient rack.
- Racks do not collect dust or dirt. • Holds all manufacturers' glove boxes of any size.
- PVC coated to resist bleaches and solvents.
- Gloves and boxes not included.

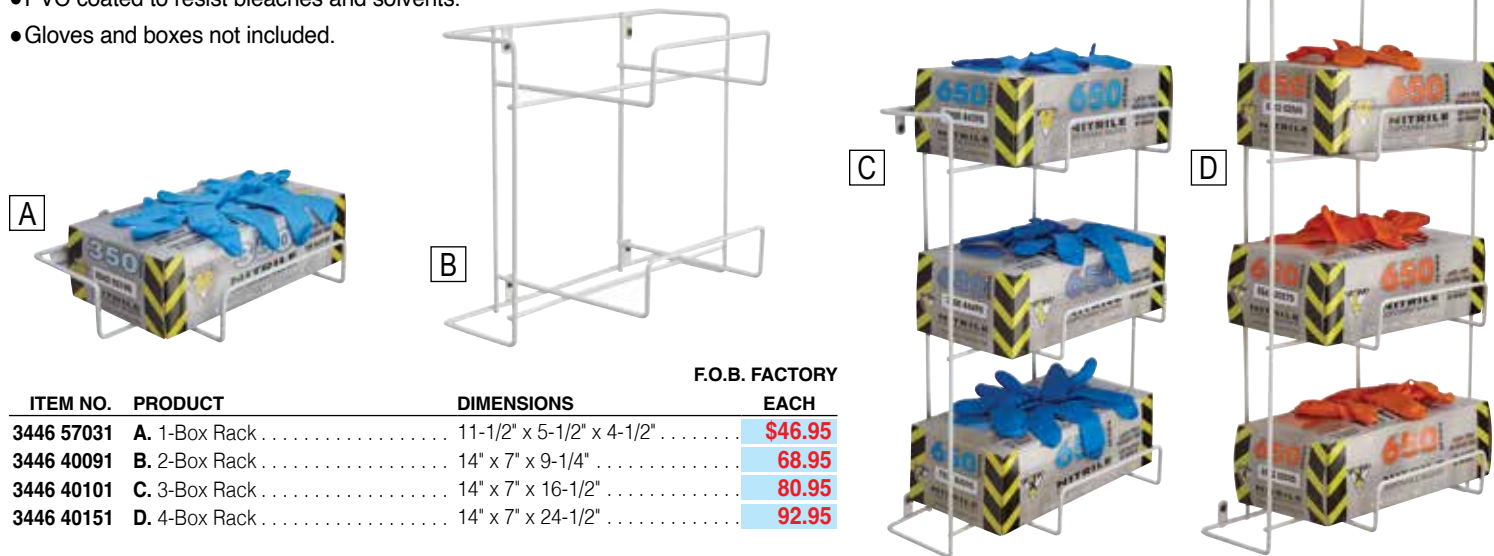

ITEM NO.	PRODUCT	DIMENSIONS	F.O.B. FACTORY EACH
3446 57031	A. 1-Box Rack	11-1/2" x 5-1/2" x 4-1/2"	\$46.95
3446 40091	B. 2-Box Rack	14" x 7" x 9-1/4"	68.95
3446 40101	C. 3-Box Rack	14" x 7" x 16-1/2"	80.95
3446 40151	D. 4-Box Rack	14" x 7" x 24-1/2"	92.95

Acrylic Glove Dispenser

Put gloves at your employees' fingertips.

- Mounts to walls with two screws (not included).
- Clear acrylic construction. • Holds one box.



NOTE: Box of gloves not included.



ITEM NO.	PRODUCT	DIMENSIONS	EACH
3364 28281	Glove Dispenser	6-3/5" x 4" x 11.1"	\$48.17

Rack'Em™ Apron Dispenser Tray

- Space saving tray holds bagged and boxed aprons, does not collect dust or dirt.
- White PVC coated steel.



NOTE: Aprons not included.

ITEM NO.	PRODUCT	DIMENSIONS	EACH
3446 40221	Apron Dispenser	20-1/2" x 15" x 6"	\$116.11

WorkHorse® Color-Coded Latex-Free Bouffant Caps

Color-coding your workplace has never been easier!

- Cool and comfortable to wear.
- Choose from seven colors for easy identification.



SAVE BIG ON SMALL QUANTITIES!
 You Won't Find A Better Deal On
 Bouffant Caps Anywhere!



▶ 100 PER BAG - 10 BAGS PER CASE.



ITEM NO.	COLOR	SIZE	BAG
E542 04615	White	18"	\$4.09
E542 04625	White	21"	4.85
E542 04635	White	24"	5.33
E542 04645	White	28"	6.69



ITEM NO.	COLOR	SIZE	BAG
E542 04655	Green. . . .	18"	\$4.09
E542 04665	Green. . . .	21"	4.67
E542 04675	Green. . . .	24"	5.36



ITEM NO.	COLOR	SIZE	BAG
E542 04695	Blue.	18"	\$4.09
E542 04705	Blue.	21"	4.64
E542 04715	Blue.	24"	5.36



ITEM NO.	COLOR	SIZE	BAG
E542 04845	Pink	21"	\$6.71
E542 04855	Pink	24"	7.31



ITEM NO.	COLOR	SIZE	BAG
E542 04885	Red	21"	\$4.78
E542 04895	Red	24"	5.55



ITEM NO.	COLOR	SIZE	BAG
E542 04865	Yellow	21"	\$4.78
E542 04875	Yellow	24"	5.55



ITEM NO.	COLOR	SIZE	BAG
E542 03805	Orange . . 21"		\$4.78
E542 04455	Orange . . 24"		5.55

WHY CALL FOR PRICING?

With product availability and costs fluctuating due to supply chain sourcing, you will see certain products displayed without a price in this Buyers Guide and instead are listed as Call for Pricing. On such items, please call our Customer Service team at 800-456-5624 or visit our website at www.bunzlpd.com where pricing is always up to date.

WorkHorse® Pleated White Bouffant Caps

- 14-gram polypropylene.
- Color: white.

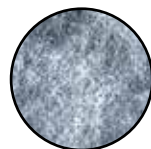

▶ 100 PER BAG - 10 BAGS PER CASE.

ITEM NO.	SIZE	BAG
E542 04735	18"	\$6.18
E542 04745	21"	6.36
E542 04755	24"	7.13



WorkHorse® Honeycomb White Weave Hairnets

- Nylon.

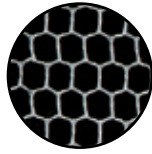

▶ 100 PER BAG - 10 BAGS PER CASE.

ITEM NO.	SIZE	BAG
E542 04775	18"	\$7.24
E542 04785	21"	8.31
E542 04795	24"	8.96

White Packers Hairnets

- 100% nylon.
- 21 inches.



ITEM NO.	PRODUCT	BAG
2819 20891	12/Bag	\$3.95
2819 20895	144/Bag	35.55

Medium Weave Hairnets

- Rayon.
- 21 inches.

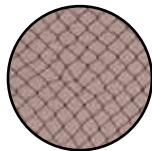

▶ 12 PER BAG - 10 BAGS PER CASE.

ITEM NO.	COLOR	BAG
3153 57045	Black	\$5.55

Rack 'Em™ Bouffant Cap and Hairnet Dispenser

- Holds all styles of hairnet/bouffant caps or beard covers — whether bagged or boxed.
- Metal rack does not collect dust or dirt.



ITEM NO.	DIMENSIONS	EACH
3446 40201	12-1/4" x 5" x 6-1/2"	\$86.11

NOTE: Bouffant caps/hairnets sold separately.

Light-Weight Nylon Hairnets

- 100% latex free.
- "Invisible" net.

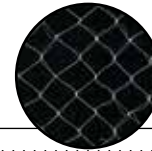

▶ 144 PER BOX - 10 BAGS PER CASE.

ITEM NO.	SIZE	CASE
3153 00025	Regular, 22"	\$16.00
3153 00015	Large, 28"	24.95

LATEX
FREE

Nylon Stockinet Hairnets

- 100% latex free.
- Fine mesh "Stockinet".
- Color: white.

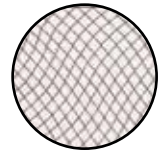

▶ 100 PER BAG - 10 BAGS PER CASE.

ITEM NO.	SIZE	BAG
3153 00075	18"	\$18.95
3153 00055	21"	22.95
3153 00065	24"	25.95

LATEX
FREE

Open Weave Rayon Hairnets

- 24 inches.

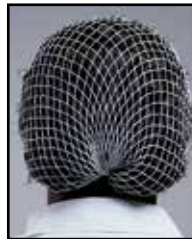

▶ 144 PER BAG - 10 BAGS PER CASE.

ITEM NO.	COLOR	BAG
3153 58795	Brown	\$36.95
3153 58805	White	36.95
3153 58815	Black	36.95

Acrylic Bouffant Dispenser

Put bouffant caps at your employees' fingertips.

- Clear acrylic construction for easy recognition of contents.
- Wall-mounted with round opening for easy access.



ITEM NO.	DIMENSIONS	EACH
3364 28261	10" x 10" x 10"	\$105.58

NOTE: Bouffant caps/hairnets sold separately.

WorkHorse® Poly Hood

A bouffant and beard guard all in one!

- Cool and comfortable to wear. • 17 inches.



▶ 1,000 PER CASE.

ITEM NO.	PRODUCT	CASE
E542 0498	White	\$152.31
E542 0490	Orange	162.07

WorkHorse® Beard Guard

- Light-weight, cloth-like and non-woven.
- Elastic band keeps guard securely in place.
- Lint-free fabric.

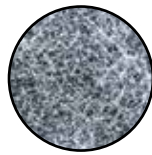

LATEX FREE

▶ 100 PER BAG - 10 BAGS PER CASE.

ITEM NO.	SIZE	COLOR	BAG
E542 04805	18"	White	\$3.91
E542 05235	18"	Orange	8.25

▶ 500 PER CASE.

ITEM NO.	SIZE	COLOR	CASE
E542 0481	21"	White	\$22.13

Beard Restraint

- Light-weight nylon.
- Color: white.

CELLUCAP MANUFACTURING

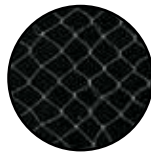

▶ 100 PER BAG - 10 BAGS PER CASE.

ITEM NO.	COLOR	BAG
2466 83135	White	\$32.05

Beard Net

- Polypropylene.
- One size fits all.
- Color: blue.



▶ 100 PER BAG - 10 BAGS PER CASE.

ITEM NO.	COLOR	BAG
3401 59785	Blue	\$7.35

WorkHorse® Polyester Honeycomb Beard Guard

- Breathable fine mesh of 100% polyester.
- Full size with easy to wear elastic fit.

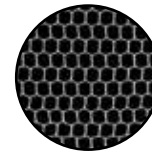

▶ 100 PER BAG - 10 BAGS PER CASE.

ITEM NO.	SIZE	COLOR	BAG
E542 04825	18"	White	\$7.85
E542 04835	18"	Blue	7.85

Nylon Beard Net

- Fine weave. • Color: white.

Safeko

LATEX FREE



▶ 1,000 PER CASE.

ITEM NO.	SIZE	CASE
3153 0003	18"	\$305.95
3153 0004	21"	308.95

Men's Overseas Style Caps

- Sturdy white kraft paper headband.
- Crown is made of soft, white paper mesh.

CELLUCAP MANUFACTURING



▶ 100 PER BAG - 10 BAGS PER CASE.

ITEM NO.	PRODUCT	BAG
2466 08265	Overseas Cap	\$12.25

SHOP 24/7 bunzlpd.com

Where you can find out what's on sale, find updated product information, reviews and pricing.

STAY CONNECTED WITH US:



Need Help?
Chat With Us
Online!



Disposable Polyethylene Aprons

Economical light-duty alternative.

- Made of polyethylene: 2 mil and 1.5 mil (heavy-duty) or 1 mil (standard).
- Smooth or embossed surface finish.
- Choose from blue, clear, red or white.
- Extra-long ties.



1 Mil Aprons

ITEM NO.	PRODUCT	SIZE	PACK
7500 72435	Smooth, White	28" x 46"	\$8.05
7500 72425	Smooth, Blue	28" x 46"	8.05
7500 72395	Embossed, Clear	28" x 46"	8.05
7500 72495	Smooth, White	24" x 42"	6.61

1.5 Mil Aprons

▶ 100 APRONS PER PACK - 5 PACKS PER CASE.

ITEM NO.	PRODUCT	SIZE	PACK
7500 72715	Smooth, Red	28" x 46"	\$14.21
7500 72695	Smooth, White	28" x 46"	13.70
7500 72675	Embossed, White	28" x 46"	15.93
7500 72485	Smooth, White	28" x 55"	17.04
7500 72755	Smooth, Blue	28" x 55"	17.59
7500 00895	Embossed, Blue	28" x 46"	20.95

2 Mil Aprons

▶ 100 APRONS PER PACK - 5 PACKS PER CASE.

ITEM NO.	PRODUCT	SIZE	PACK
7500 72735	Smooth, White	28" x 46"	\$16.90
7500 72725	Embossed, White	28" x 46"	18.90

Polyethylene-Coated Disposable Aprons

Ideal for grimy, non-hazardous work environments.

- Breathable, comfortable, spun, non-woven fabric with a moisture resistant polyethylene coating.
- Lightly textured finish.
- Sewn ties. • Weight: 1.25 ounces.
- Color: white.



▶ SOLD IN CASES OF 100.

ITEM NO.	SIZE	COLOR	CASE
4724 2510	28" x 36"	White	\$86.95



Smooth Light-Duty Poly Aprons, 1 Mil

- Individually wrapped.
- Available in white or blue.



▶ 100 INDIVIDUALLY WRAPPED APRONS PER BOX - 10 BOXES PER CASE.

ITEM NO.	SIZE	COLOR	BOX
7500 72505	24" x 42"	White	\$9.10
7500 72445	28" x 46"	White	10.45
7500 70375	28" x 46"	Blue	12.41

Rack'Em™ Apron Dispenser Tray

- Space saving tray holds bagged and boxed aprons, does not collect dust or dirt.
- PVC-coated steel.



Aprons sold separately.



ITEM NO.	DIMENSIONS	EACH
3446 40221	20-1/2" x 15" x 6"	\$116.11

Vinyl Retail Apron

Available in 6 easy-to-clean colors.

- Vinyl remains pliable in temperatures down to -32 °F.
- 31 inches x 39 inches with pencil pocket on bib.
- Excellent moisture-resistance.
- Metal grommets at stress points; string ties at waist.
- 6 mil thickness.



Available in 6 colors.

► 12 PER CASE.

ITEM NO.	COLOR	EACH
4465 91001	White	\$6.95
4465 91011	Red	6.95
4465 91021	Green.	6.95
4465 91031	Blue	6.95
4465 91041	Clear	6.95
4465 91061	Yellow	6.95



Vinyl Replacement Aprons

Out performs comparable PVC and vinyl products 3:1.

- VR™ material is softer, flexible and lighter weight.
- Available in translucent blue, opaque yellow or white.
- Choose between die cut and tie.



► 100 PER CASE.

ITEM NO.	PRODUCT	SIZE/COLOR	CASE
3386 4263	A. 4 Mil, Tie35" x 45" Yellow	\$222.66
3386 4222	4 Mil, Tie35" x 45" White.	222.66
3386 3756	6 Mil, Tie35" x 45" Blue.	283.29
3386 4265	6 Mil, Tie35" x 45" Yellow	297.28
3386 4224	6 Mil, Tie35" x 45" White.	283.29
3386 3757	6 Mil, Tie35" x 55" Blue.	342.75
3386 3753	B. 6 Mil, Die Cut35" x 55" Blue.	256.46

6 and 8 Mil Vinyl Aprons

Our best selling vinyl aprons.

- Protection from oil, fat, grease and salt.
- Made of quality vinyl with nylon-serged edges and four heat-sealed grommets.
- Ties in each apron. • Width: 35 inches.



Heat sealed grommet and serged edges are easy to clean and maintain.

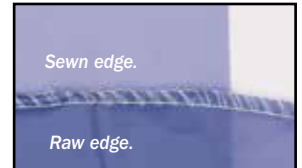

Sewn edge.

Raw edge.



8 mil white, raw edge.



Die cut apron.

A. Vinyl Apron with Tie

► 12 PER PACK - 6 PACKS PER CASE.

ITEM NO.	PRODUCT	SIZE/COLOR	PACK
7500 70015	6 Mil, Raw	45" Blue	\$22.08
7500 70025		48" Blue	22.62
7500 70035		50" Blue	23.02
7500 70045		55" Blue	25.40
7500 70065	6 Mil, Sewn	45" Blue	23.02
7500 70075		48" Blue	23.02
7500 70355		48" White	25.40
7500 70085		50" Blue	23.81
7500 70095		55" Blue	25.56
7500 70265	8 Mil, Sewn	45" Blue	25.40
7500 70275		48" Blue	27.78
7500 70295		55" Blue	26.52
7500 70285	8 Mil, Raw	45" White	25.17

B. Die Cut Vinyl Apron

ITEM NO.	PRODUCT	SIZE/COLOR	PACK
E542 10985	6 Mil, Die Cut.	33" x 47" Blue.	\$28.25
7500 01915	8 Mil, Die Cut.	35" x 48" White.	44.05



WARNING:

Some products in this catalog may expose you to chemicals including DEHP Di (2-ethylhexyl) phthalate or BPA (Bisphenol A) which are known to the State of California to cause cancer or birth defects or other reproductive harm. For more information, visit www.P65Warnings.ca.gov.

Endurosaf™ High Performance Aprons

Outperforms vinyl, neoprene, nitrile, even Hycar.
Resistant to bacteria and staining.

- Provides ten times the abrasion-resistance of PVC, five times that of vinyl.
- Ten times as resistant to fats and oils as vinyl.
- Remains flexible in cold temps down to -65 °F; withstands heat up to 180 °F.
- Material returns to original shape even after a variety of physical and temperature stresses.
- Thickness: 8 mil. • Weight: 6 ounces.

**NEVER BEFORE
HAS THERE BEEN AN APRON THIS
TOUGH, THIS LIGHT-WEIGHT.**

ITEM NO.	COLOR	SIZE
2201 19231	White	35" x 50"
2201 19261	Yellow	35" x 50"
2201 19291	Blue	35" x 50"

► 24 PER CASE.
CASE
\$28.16



Ansell



Self-material waist ties are long enough to tie in front or back.



Satin finish wipes clean and is machine washable.



Strong enough for the toughest of applications.



Adjustable dielectrically sealed, self-material neck strap.

Endeavor and Die Cut Endeavor Aprons

- Provides ten times the abrasion-resistance of PVC and five times that of vinyl.
- Remains flexible in cold temperatures down to -65 °F; withstands heat up to 180 °F.
- Material returns to original shape even after a variety of physical and temperature stresses.
 - Slick finish allows for easy clean-up — machine washable.
 - One Endeavor apron will outlast dozens of disposable aprons.
 - 5.5 mil thickness. • 100% non-toxic. • 100% recyclable.
- 50 inches L x 35 inches W. • Resistant to fats, oils and chemicals.



Adjustable dielectrically sealed, self-material neck strap.



Self-material waist ties are long enough to tie in front or back.



Tougher, lighter, better quality, lasts longer than vinyl, neoprene, nitrile, Hycar for a fraction of the price!



One-piece, self-material neck strap and waist ties for added strength.



Endeavor Apron

ITEM NO.	COLOR
5644 35531	White
5644 35541	Yellow
5644 35521	Blue

► 10 PER CASE - SOLD INDIVIDUALLY.

EACH
\$13.25

Die Cut Endeavor Apron

ITEM NO.	COLOR
5644 35455	White
5644 35465	Yellow
5644 35475	Blue

► 12 PER CASE.

CASE
\$118.35



“54-40” Style Double-Sided Belly Patch Neoprene Apron

Heavy cotton sheeting, evenly coated on both sides with neoprene.

- Waterproof, flexible, abrasion-resistant
- Weight: 2-1/2 pounds.
- 48 inches L x 35 inches W.
- Brass grommets.



Sewn and sealed belly patch.

Double-Coated on both sides.

▶ 12 PER CASE.

ITEM NO.	COLOR	EACH
G070 05701	Yellow	\$35.14

Chemical-Resistant Neoprene Apron

- Hemmed on all four sides.
- Adjustable cloth neck strap.
- 36-inch sewn ties.
- Dimensions:
Maroon and White: 16 ounces; 48 inches L x 35 inches W.
Yellow: 22 ounces (25 mil); 45 inches L x 35 inches W.



Snap-on cloth necks trap adjusts easily.

▶ 12 PER CASE.

ITEM NO.	COLOR
3279 22181	Maroon
3279 41321	White
3279 90201	Yellow

EACH
\$24.75

Neoprene Kill Floor Apron

Our most popular apron for kill floor applications.

- Neoprene coated twice on the front, this apron will not absorb water.
- Every edge is hemmed.
- Weight: 16 ounces.
- 45 inches L x 35 inches W.
- 36-inch sewn ties with metal grommets.



Sewn neck band does not adjust.

▶ 12 PER CASE.

ITEM NO.	COLOR	EACH
3279 35461	Maroon	\$18.08



18 Mil Green Vinyl Aprons

Ansell

- Die-cut vinyl apron with nylon-serged edges and four heat-sealed grommets.
- Protection from oil, fat, grease and salt.
- String ties provided with each apron.

▶ 12 PER CASE.

ITEM NO.	SIZE	CASE
2201 0851	Apron w/Patch	\$107.04
2201 0883	Apron w/o Patch	111.73



WARNING: Some products in this catalog may expose you to chemicals including DEHP Di (2-ethylhexyl) phthalate or BPA (Bisphenol A) which are known to the State of California to cause cancer or birth defects or other reproductive harm. For more information, visit www.P65Warnings.ca.gov.



16 Mil Hycar Apron

Offering the highest level of abrasion-resistance.

- 16 ounce heavy-coated hycar aprons.
- Resistance to animal fats and oils.
- Cloth neck strap, reinforced nickel plated brass grommets and 36-inch waist ties.
- 48 inches L x 35 inches W.
- Available in white, black and yellow.



All edges are sewn.

ITEM NO.	COLOR	▶ 12 PER CASE.
3279 10161	White	EACH
3279 10171	Black	\$23.34
3279 10181	Yellow	\$23.34



Hycar Apron with Mini Brute Belly Patch

Nitrile coating resists acids, blood, caustics, oils, animal fats and abrasions.

- USDA accepted for food and meat handling.
- 18 mil apron with 29 mil belly patch.
- Turned edges, reinforced bib and nickel-plated brass and side grommets.
- Separate poly cord ties.
- 48 inches L x 35 inches W.
- Adjustable snap buckle with safety release.
- Stitched seams. • Weight: 23 ounces.



Cross section of Brute belly patch. Patch is cured directly into fabric.

ITEM NO.	COLOR
3045 29291	White

▶ 12 PER CASE.
EACH
\$37.13



Nitrile Apron with Belly Patch

Flexible, waterproof nitrile with double coated belly patch.

- Belly band for increased protection.
- Adjustable neck strap.
- Sewn edges. • 48 inches L x 35 inches W.



Adjustable necks trap.

▶ 12 PER CASE.

ITEM NO.	COLOR	EACH
G070 05401	Yellow	\$31.75



22 Mil General Purpose Nitrile Apron

Economical, heavy-duty nitrile apron coated on both sides.

- Heavy-duty nitrile on a cotton base fabric.
- Snap-on neck band made of polypropylene.
- All edges are hemmed.
- 48 inches L x 35 inches W.
- Weight: 22 ounces.



Double-coated.

▶ 24 PER CASE.

ITEM NO.	COLOR	EACH
3419 90001	Yellow	\$26.05



25 Mil Nitrile Apron

For heavy-duty protection.

- 45 inches L x 35 inches W.
- Color: white.



Heavy-duty nylon strap.

▶ 24 PER CASE.

ITEM NO.	COLOR	EACH
5913 10451	White	\$25.33



Also available in 5 ounce white with snap on cloth neck strap. See below.

15 Mil Economy PVC Apron

Light-weight, yet durable.

- Made of 15-ounce PVC coated nylon fabric.
- Adjustable self-material neck band.
- String ties at waist, sewn edges and hem.
- 47 inches L x 35 inches W. • Color: yellow.

▶ 48 PER CASE.

ITEM NO.	COLOR	EACH
3296 12651	Yellow	\$7.95



WARNING: See page 2. www.P65Warnings.ca.gov.

6 Mil Poly/Nylon Apron

Durable and light-weight.

- Light-weight polyurethane-coated nylon.
- Abrasion-resistance and protection from water.
- Width: 35 inches.

Nylon serged edges are easy to clean and maintain.



▶ 4 DOZEN PER CASE.

ITEM NO.	COLOR	CASE
4804 00485	48" Yellow	\$99.85
4804 43165	48" Blue	99.85
4804 35555	55" Yellow	102.05
4804 08535	55" Blue	102.05

5 Mil Champion Urethane Aprons

Light-weight and flexible in cold temperatures.

- 5-ounce urethane coating on 200 denier nylon.
- Very resistant to abrasions, yet sheds liquid with ease.



Snap-on cloth neck strap adjusts easily.

▶ 12 PER CASE.

ITEM NO.	COLOR	CASE
5913 66411	35" x 45" Yellow	\$24.55
5913 66221	35" x 45" White	24.55
5913 66321	35" x 50" Yellow	27.95

Rubber Apron Clips

- Fasten the back of your apron without tie strings.
- Adjustable clip maintains even tension at all times.

▶ 12 PER CASE.

ITEM NO.	PRODUCT	EACH
4465 93901	Apron Clips	\$6.75





WorkHorse® Disposable Polyethylene Gowns

An economic, light-duty alternative in protective wear.

- Embossed.
- Open back with ties.
- Two cuff options: elastic or thumb loop.
- Available in 1.25, 1.75 and 3 mil.

1.25 Mil

▶ 100 PER CASE - 36 CASES PER PALLET.

ITEM NO.	SIZE	COLOR	WRIST	CASE
E542 0519	Small/Tall, 38" x 55"	Blue	Elastic	\$82.65
E542 0520	Small/Tall, 38" x 55"	White	Elastic	82.65
E542 0938	Small/Tall, 38" x 55"	Blue	Thumb Loop	88.95
E542 0521	Small/Short, 38" x 46"	Blue	Elastic	79.95

1.75 Mil

▶ 25 PER PACK - 4 PACKS PER CASE - 36 CASES PER PALLET.

ITEM NO.	SIZE	COLOR	WRIST	CASE
E542 1045	Small/Short, 38" x 45"	White	Thumb Loop	\$105.50
E542 1050	Medium/Standard, 44" x 50"	Blue	Thumb Loop	111.55
E542 2255	Medium/Tall, 44" x 55"	Blue	Thumb Loop	115.95
E542 1046	Large/Short, 59" x 45"	White	Thumb Loop	111.55
E542 1155	Large/Tall, 59" x 55"	White	Thumb Loop	119.95

3 Mil

▶ 25 PER PACK - 4 PACKS PER CASE - 36 CASES PER PALLET.

ITEM NO.	SIZE	COLOR	WRIST	CASE
E542 0553	Small/Tall, 38" x 55"	Blue	Thumb Loop	\$119.95
E542 0353	Small/Tall, 38" x 55", Full Back	Blue	Thumb Loop	122.95



Yellow shown.

Thumb loops.



Elastic cuffs.



Self-tie.

Smooth Disposable Polywear™ Gowns

- Light-weight polyethylene, non-linting smooth construction.
- Easy, tear-away feature for quick gown removal and safe disposal.
- Contoured thumb loops secure gown sleeves.
- Full length open-back design for better comfort and shoulder coverage.
- Size: XL



Open back.

ITEM NO.	COLOR
3386 0620	Blue
3386 0624	Yellow

▶ 75 PER CASE.

CASE
\$122.42

6 Mil Blue Vinyl Coat Smocks

Extra protection from grease, oil and fat.

- All grommets are heat sealed and all edges are sonically sealed.
- No metal parts to cause static and corrosion; no stitching for acid to eat through.
- Open back with ties.

ITEM NO.	SIZE
3419 09601	Small
3419 09611	Medium
3419 08261	Large
3419 09621	X-Large

▶ 24 PER CASE.

EACH
\$9.65

Vinyl Replacement Gowns

Extruded triple layer material out performs comparable PVC and vinyl products 3:1.

- VR material is softer, flexible and lighter weight.
- Odorless, non-toxic and 100% recyclable.
- Gown interior is pebbled; no static electricity.
- 4 mil VR is as strong as to 6 mil PVC. 6 mil VR is as strong as to 8 mil PVC.
- Available in thumb loop and elastic cuff styles.

Thumb Loop

▶ 50 PER CASE.

ITEM NO.	PRODUCT	SIZE	COLOR	CASE
3386 6659	4 Mil, 38" x 45"	Regular	Blue	\$188.63
3386 0012	4 Mil, 38" x 45"	Regular	White	188.63
3386 6660	4 Mil, 42" x 50"	Large	Blue	228.92
3386 6661	4 Mil, 45" x 55"	X-Large	Blue	337.02
3386 6664	6 Mil, 45" x 55"	X-Large	Blue	472.71

Elastic Wrist

ITEM NO.	PRODUCT	SIZE	COLOR	CASE
3386 2454	4 Mil, 38" x 45"	Regular	Yellow	\$238.45
3386 2588	4 Mil, 42" x 55"	X-Large	Red	383.66
3386 5375	6 Mil, 42" x 50"	Large	Blue	364.58



WARNING: Some products in this catalog may expose you to chemicals including DEHP Di (2-ethylhexyl) phthalate or BPA (Bisphenol A) which are known to the State of California to cause cancer or birth defects or other reproductive harm. For more information, visit www.P65Warnings.ca.gov.



Heavy-Weight Disposable Coveralls

1.6 ounces with Microforce™ barrier
SMS fabric, which offers protection against dry particulates
and light liquid sprays.

- Made from a light-weight, breathable SMS polypropylene fabric.
- Strong and abrasion-resistant.



Elastic wrists
and ankles.

- For extended wear applications.
- Colors: white or blue.

Blue

ITEM NO.	SIZE
1540 0286	Medium
1540 8503	Large
1540 0279	X-Large
1540 8505	2X-Large
1540 8506	3X-Large

SPECIAL
ORDER
ITEM

► 24 PER CASE.
(3XL SIZE: 20 PER CASE)

CASE
\$184.74

White

ITEM NO.	SIZE
1540 8246	Medium
1540 8248	Large
1540 8250	X-Large
1540 8244	2X-Large
1540 8245	3X-Large

Zipper front.



ProMax® Disposable Coveralls

- Constructed of 11.5-ounce polypropylene.
- Zipper front.
- Color: white.

ITEM NO.	SIZE
4724 0120	Large
4724 0121	X-Large
4724 0122	2X-Large

► 25 PER CASE.

CASE
\$108.95



KleenGuard A-10 Disposable Lab Coats

2 ounces offers light-duty protection against dirt, grime and certain non-hazardous dry particulates.

- Manufactured from light-weight spunbound polypropylene fabric.
- Light-weight and cool to wear.
- Long sleeves, no pockets.
- Repels water yet breaths to control perspiration.

4-snap front.



Elastic wrists.

ITEM NO.	SIZE
1540 0402	Large
1540 0403	X-Large
1540 0404	2X-Large
1540 0405	3X-Large

► 50 PER CASE.

CASE
\$177.39



WorkHorse® Polypro Lab Coats

Constructed of cool, comfortable and light-weight polypropylene.

- 1.25-ounce lab coat has snaps, long sleeves and no pockets.



DISPOSABLE CLOTHING

SIGN UP FOR OUR eDEALS

eDEAL SIGN-UP FORM

AVAILABLE ON OUR WEBSITE

www.bunzlpd.com

WHITE ITEM NO.	RED ITEM NO.	BLUE ITEM NO.	SIZE	▶ 30 PER CASE. CASE
E542 0301	E542 0328	E542 0310	Large	\$41.35
E542 0302	E542 0329	E542 0311	X-Large	41.35
E542 0303	E542 0330	E542 0312	2X-Large	41.35
E542 0304	E542 0331	E542 0313	3X-Large	42.45
E542 0305	E542 0332	E542 0314	4X-Large	43.55
E542 0306	E542 0333	E542 0315	5X-Large	44.65
E542 0307	E542 0334	E542 0316	6X-Large	46.85



Tyvek® Bib Aprons

Tyvek® provides breathable inherent barrier protection against hazardous dry particles, aerosols and non-hazardous liquid splash.

- Comfort fit design allows for a greater range of motion and fewer blowouts.
- Bound seams, neck and ties.
- Bib-style.
- One size fits all.

▶ 100 PER CASE.

ITEM NO.	SIZE	CASE
3171 0784	28" x 36"	\$219.05

Cotton Bib Aprons

- 65/35 poly/cotton blend.
- Available with or without pencil pocket.
- Sewn neck band. • Grommets at stress points.
- Waist tie string. • 35 inches L x 30 inches W.



Cotton Bib Apron with pocket.

▶ 1 DOZEN APRONS PER PACK - 10 PACKS PER CASE.

ITEM NO.	SIZE/COLOR	PACK
3092 08415	3.5 oz. w/o Pocket, White	\$90.65
3092 08795	7 oz. w/o Pocket, White	123.05
3092 08455	7 oz. w/Pocket, White	123.05
3092 9007	7 oz. w/Pocket, Navy	140.35



Cotton Work Clothing

- Permanent press finish.
- Shirts are white, short sleeved with snap front and chest pocket.
- Pants are white, unhemmed, with 4 pockets and zipper fly.
- 65/35 cotton/poly blend.

Shirts

ITEM NO.	SIZE	PER CASE
4689 0373	Medium	\$14.25
4689 0372	Large	
4689 5003	X-Large	

▶ 6 PER CASE.

Pants

ITEM NO.	SIZE	PER CASE
4689 0323	30" Waist	\$21.75
4689 0431	32" Waist	
4689 2025	34" Waist	
4689 2026	36" Waist	
4689 2024	38" Waist	
4689 2109	40" Waist	
4689 2027	42" Waist	

▶ 6 PER CASE.

SPECIAL ORDER ITEM



7-Ounce Cotton Butcher Jackets

- Nickel-plated 4-snap front closure.
- Permanent press 65/35 poly/cotton blend.
- Outside pockets.

▶ 12 PER CASE.

ITEM NO.	SIZE	EACH
3092 26101	2 Pocket, Small	\$29.10
3092 26111	2 Pocket, Medium	29.10
3092 26121	2 Pocket, Large	29.10
3092 26131	2 Pocket, X-Large	29.10
3092 70161	2 Pocket, 2X-Large	32.35
3092 70171	2 Pocket, 3X-Large	33.45
3092 31381	3 Pocket, Small	29.10
3092 31391	3 Pocket, Medium	29.10
3092 31401	3 Pocket, Large	29.10
3092 31411	3 Pocket, X-Large	29.10

Clear PVC Duffel Bag

Provides a compliant alternative for the workplace.

- Constructed of transparent, tear-resistant PVC for easy viewing of bag contents.



► 50 BAGS PER CASE.

ITEM NO.	PRODUCT	DIMENSIONS	EACH
7600 06211	PVC Duffel Bag	18" x 9" x 10"	\$8.82

Laundry Detergent Powder

Economical, biodegradable, low phosphate.

- Optical brighteners and borax stain removers.
- Meets B1 guidelines.
- Water softening ingredients.
- Pleasant lemon scent.



ITEM NO.	PRODUCT	EACH
2117 2126	25-lb Bucket	\$106.22

Heavy-Duty Laundry Pins

- High quality at a low cost.
- Large, 4-1/4 inches.



► 100 PER CASE.

ITEM NO.	PRODUCT	EACH
3544 4791	4-1/4" (0.136" Wire)	\$2.45

SHOP 24/7
bunzlpd.com



Need Help?
 Chat With Us
 Online!

STAY CONNECTED WITH US:



Where you can find out what's on sale, find updated product information, reviews and pricing.





Snap-Front Poly/Cotton Butcher Frock

Roomy bell-shape eliminates the need for slit back.

7-Ounce White, Long Sleeved Frock

Easy care permanent press 65/35 poly/cotton blend.

- Dome style snaps.
- Available in four styles:
 - 4 outside pockets; 2 inside pockets;
 - 2 outside pockets; or no pockets with 2 side slits to allow access to pant pockets.

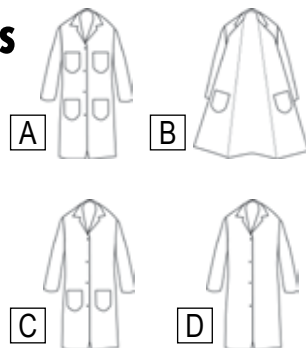

MADE IN USA

A. 4 OUTSIDE POCKETS	B. 2 INSIDE POCKETS	C. 2 OUTSIDE POCKETS	D. NO POCKETS	SIZE	EACH
3092 31341	3092 61051	3092 47051	---	Small	\$35.60
3092 31351	3092 61061	3092 47061	3092 30601	Medium	35.60
3092 31361	3092 61071	3092 47071	3092 30611	Large	35.60
3092 31371	3092 61081	3092 47081	3092 30621	X-Large	35.60
3092 57841	3092 61091	3092 47091	3092 30631	2X-Large	36.65
3092 30661	3092 61101	3092 47101	3092 30641	3X-Large	37.75
3092 30671	---	3092 47111	3092 30651	4X-Large	38.85

▶ 12 PER CASE.

Some frock orders may need a 5-6 week lead time. Ask a CSR for details.

5-Ounce White Frock

Light-weight, easy care permanent press 65/35 poly/cotton blend.

A. 4 OUTSIDE POCKETS	B. 2 INSIDE, 2 OUTSIDE POCKETS	SIZE	EACH
3092 55401	3092 55451	Small	\$32.35
3092 55411	3092 55461	Medium	32.35
3092 55421	3092 55471	Large	32.35
3092 55431	3092 55481	X-Large	32.35
3092 30761	3092 30771	2X-Large	35.60

▶ 12 PER CASE.

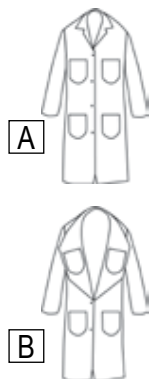

11-Ounce White Frock

Heavy-weight, durable 50/50 poly/cotton blend.

A. 4 OUTSIDE POCKETS	B. 2 INSIDE, 2 OUTSIDE POCKETS	SIZE	EACH
3092 45461	3092 09111	Medium	\$38.85
3092 45471	3092 09121	Large	38.85
3092 45481	3092 09131	X-Large	38.85
3092 56091	3092 09141	2X-Large	41.00

▶ 12 PER CASE.

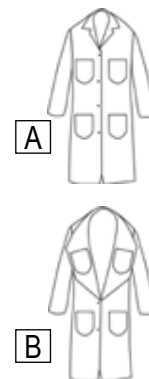

7-Ounce Color Frock, Long Sleeved

- Style available: 4 outside pockets plus 2 side slits to allow access to pant pockets.
- Gripper style front snaps.



Available in five colors: light blue, dark blue, burgundy, medium gray and brown.

DARK BLUE	LIGHT BLUE	BROWN	BURGUNDY	MED. GRAY	SIZE	EACH
3092 04421	3092 92051	3092 23551	3092 22351	3092 06551	Small	\$41.00
3092 04431	3092 92061	3092 23561	3092 22361	3092 06561	Medium	41.00
3092 04441	3092 92071	3092 23571	3092 22371	3092 06571	Large	41.00
3092 04451	3092 91351	3092 23581	3092 22381	3092 06581	X-Large	41.00
3092 30731	3092 30721	3092 23591	3092 22391	3092 06591	2X-Large	44.25

▶ 12 PER CASE.



MADE IN USA

Wrap-Around Butcher Frocks

5-Ounce White, Wrap-Around Frocks with 3/4 Length Sleeves

Easy care permanent press 80/20 poly/cotton blend.

- Bar-tacks at stress point for added strength.
- Styles available: 3 outside pockets, (2 hip pockets and 1 breast pocket) or no pockets.

A. 3 OUTSIDE POCKETS		B. NO POCKETS		SIZE	EACH
3092 81331	C443 21001	Small			\$32.35
3092 81341	C443 21011	Medium			32.35
3092 81351	C443 21021	Large			32.35
3092 81361	C443 21031	X-Large			32.35
3092 81371	C443 21041	2X-Large			39.90

7-Ounce White Heavy Wrap-Around Frocks with 3/4 Length Sleeves

Easy care permanent press 65/35 poly/cotton blend.

- Overall length: 45 inches.
- 3/4 length sleeve.
- Side pocket slits for access to pant pockets.
- Available in two styles: 2 outside hip pockets, inside breast pocket or no pockets.

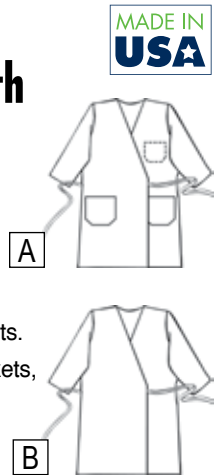

A. 1 INSIDE, 2 OUTSIDE POCKETS		B. NO POCKETS		SIZE	EACH
3092 46901	---	Small			\$34.50
3092 23341	3092 13341	Medium			34.50
3092 23351	3092 13351	Large			34.50
3092 23361	3092 13361	X-Large			34.50
---	3092 13371	2X-Large			36.65

FROCK SIZE CHART

SIZE	WEIGHT	HEIGHT	MEN'S SIZE	WOMEN'S SIZE	KNEE FROCK LENGTH
Small	110 - 140 lb	5' - 5'4"	34-36	8-10	40-1/2"
Medium	120 - 170 lb	5'2" - 5'7"	38-40	12-14	42"
Large	150 - 200 lb	5'4" - 5'11"	42-44	16-18	44"
X-Large	180 - 230 lb	5'6" - 6' 2"	46-48	20-22	45-1/2"
2X-Large	200 - 250 lb	5'8" - 6'4"	50-52	24-26	47-1/2"
3X-Large	240 - 280 lb	5'10" - 6'6"	54-56	28-30	48-1/2"
4X-Large	270 - 320 lb	6' - 6'8"	58-60	32-34	49-1/2"

Some frock orders may need a 5-6 week lead time. Ask a CSR for details.

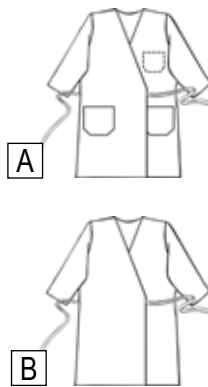

CUSTOM EMBROIDERY AVAILABLE

Would you like your company logo or employee names custom embroidered on your clothing?

YOUR NAME
Dave

1. Choose **BLOCK** or *Script* lettering.
2. Choose your lettering color.
3. Choose location of embroidery (left or right).

	EACH	
	1-2	3+
1-Line of Text . . .	\$8.40	\$6.30
Multiple Lines . . .	CALL FOR PRICING	

CALL 800-456-5624 for more information and to place your order.

5-Ounce Color Wrap-Around Frocks with 3/4 Length Sleeves

- Bar-tacks at stress point for added strength.
- Style available: 3 pockets (1 breast and 2 hip pockets).



Available in three colors: tan, light blue and navy.

SPECIAL ORDER ITEM



▶ 12 PER CASE.

LIGHT BLUE	TAN	NAVY	SIZE	EACH
3092 84331	3092 82331	3092 79331	Small	\$35.60
3092 84341	3092 82341	3092 79341	Medium	35.60
3092 84351	3092 82351	3092 79351	Large	35.60
3092 84361	3092 82361	3092 79361	X-Large	35.60
3092 84371	3092 82371	3092 79371	2X-Large	36.65

Economy, 3-Piece PVC Rainsuit

Jacket, hood and trousers in a small, easy-to-store, reusable package.

- 0.10 mm thickness.
- Jacket has 2 front flap pockets.
- Pants have an elastic waist.
- Take-ups at cuffs and ankles.



Detachable drawstring hood included.



Entire rainsuit folds down to 9-1/2 inches x 7 inches.



ITEM NO. SIZE

3314 88541	Medium
3314 88551	Large
3314 88561	X-Large
3314 88571	2X-Large
3314 88581	3X-Large

► 50 PER CASE.

EACH

\$12.14



VR™ Rainwear

VR™ — Vinyl Replacement material offers superior tensile strength, flexibility and puncture resistance.



- Naturally soft and light-weight.
- Cold-crack and tear-resistant.
- 3-inch VR™ patches are sealed into the crotch and underarm for added protection against breakdown.
- Overalls with adjustable elastic quick-release suspenders.
- Comfort-fit design with oversized snaps for quick donning and doffing.
- Impervious to fats and oils; resistant to acid chemicals.
- Odorless, non-toxic, easy-to-clean and disinfect.

Jacket

ITEM NO. SIZE

3386 60001	Small
3386 60011	Medium
3386 60021	Large
3386 60031	X-Large
3386 60041	2X-Large
3386 60051	3X-Large

► 12 PER CASE.

EACH

\$23.84

Overalls

ITEM NO. SIZE

3386 61001	Small
3386 61011	Medium
3386 61021	Large
3386 61031	X-Large
3386 61041	2X-Large
3386 61051	3X-Large

► 12 PER CASE.

EACH

\$23.84

Squall Raincoat

Clear PVC raincoat provides maximum coverage!

- 0.20 mm single-ply clear PVC with welded seams.
- 2 patch pockets with PVC flaps and white plastic snaps.
- Detachable drawstring hood.
- Rounded PVC collar.
- White plastic snap storm fly front.
- White plastic take up snaps at wrists.
- Cape ventilated back with mesh holes.



Detachable hood.



Vented back.



Cuff take-up.



Vented underarm.



ITEM NO. SIZE

3314 20721	Small
3314 20731	Medium
3314 20741	Large
3314 20751	X-Large
3314 20761	2X-Large
3314 20771	3X-Large

► 20 PER CASE.

EACH

\$16.13

SQUALL RAINCOAT SIZE CHART

SIZE	FRONT LENGTH	BACK LENGTH	TOP OF SLEEVE	BOTTOM OF SLEEVE	CUFFS	COLLAR	HOOD HEIGHT
Small	49"	49"	28-1/2"	16"	7"	17-1/2"	14"
Medium	52"	49"	30"	17"	7-1/4"	17-1/2"	14"
Large	54"	49"	31-1/2"	17"	7-1/2"	18"	14-1/2"
X-Large	57"	49"	32-1/2"	19"	7-1/2"	18"	14-1/2"
2X-Large	60"	49"	33-1/2"	19"	7-3/4"	18-1/2"	15"
3X-Large	63"	49"	34-1/2"	19"	7-3/4"	18-1/2"	15"
4X-Large	65"	49"	35-1/2"	21"	7-3/4"	19"	15-1/2"



WARNING:

Some products in this catalog may expose you to chemicals including DEHP Di (2-ethylhexyl) phthalate or BPA (Bisphenol A) which are known to the State of California to cause cancer or birth defects or other reproductive harm. For more information, visit www.P65Warnings.ca.gov.



DuraScrim™ 3-Piece Double-Coated PVC on Polyester Rainsuit

Jacket, overalls and detachable hood. 8-ounce material weight, 10.5 mil thick.

- Tear-resistant, open weave polyester scrim fabric is sandwiched between two layers of flame resistant PVC coating.
- Flame resistant self-extinguishing with flameout and afterglow less than or equal to 2 seconds after removal of ignition source. Test method ASTM D6413.
- Therm-O-Rad sealed seam construction for good chemical splash protection and 100% waterproof protection.
- Full cut shoulder with 90° sleeve to body angle for maximum freedom of movement.
- Storm fly front seals out wind, rain and contaminants.
- Non-conductive, non-corrosive snaps and buckles.
- Thicker outside coating for better abrasion resistance — lighter interior coating protects fabric from chemical contamination.

TINGLEY



Detachable hood.



Therm-O-Rad sealed seams.



Storm fly front.



Take-up snaps on ankle cuffs, sleeves and waist ensure the best fit.

ITEM NO.	SIZE
4059 63071	Small
4059 63081	Medium
4059 63091	Large
4059 63101	X-Large
4059 63111	2X-Large
4059 63121	3X-Large
4059 63131	4X-Large
4059 63141	5X-Large

▶ 12 PER CASE.

EACH
\$35.80

Webdri® PVC on Polyester Rainsuit

Yellow, 12 ounce material weight, 26 mil thick.

- Heavy coating and a high-loft lining can withstand extensive laundering and work duty.
- Therm-O-Rad sealed seams with non-woven lining defies punctures and tears as well as dissipates moisture.
- Special PVC coating resists fats and oils.
- Full cut shoulder with 90° sleeve to body angle for maximum freedom of movement.
- Storm fly front seals out wind, rain and contaminants.
- Premium snap-lock suspender buckles.
- Heavy-duty snaps guaranteed not to fail.



Detachable hood.



High loft lining.

Overalls

▶ 12 PER CASE.

ITEM NO.	SIZE	EACH
4059 01201	Small	\$39.50
4059 01211	Medium	39.50
4059 01221	Large	39.50
4059 01231	X-Large	39.50
4059 01241	2X-Large	44.10
4059 01251	3X-Large	44.10

Jacket w/Hood Snaps

▶ 12 PER CASE.

ITEM NO.	SIZE	EACH
4059 01311	Medium	\$39.40
4059 01321	Large	39.40
4059 01331	X-Large	40.60
4059 01341	2X-Large	43.00
4059 01351	3X-Large	43.00

Hood w/Snaps

▶ 12 PER CASE.

ITEM NO.	SIZE	EACH
4059 11081	One Size	\$12.70

TINGLEY



WARNING:

Some products in this catalog may expose you to chemicals including DEHP Di (2-ethylhexyl) phthalate or BPA (Bisphenol A) which are known to the State of California to cause cancer or birth defects or other reproductive harm. For more information, visit www.P65Warnings.ca.gov.

Eagle™ Breathable Polyurethane on Nylon Rainsuit **TINGLEY**

Yellow, 4.5 ounce material weight, 9 mil thick.

- Constructed of 200 denier nylon and coated on the inside with polyurethane.
- Light-weight material for all day comfort and wear.
- Durable water repellency coating for 100% waterproof protection.
- Storm fly front seals out wind, rain and contaminants.
- Pants have an elastic drawstring waist with a snap fly front.
- Premium snap-lock suspender buckles.
- Non-conductive, non-corrosive snaps and buckles.
- Generously cut to fit over the heaviest of work clothes.
- Breathable Test Method ASTM E96.

Acid Suits > SEE PAGE 92

Jacket w/Hood Snaps

> 12 PER CASE.

ITEM NO.	SIZE	EACH
4059 72041	Small	\$46.40
4059 72051	Medium	46.40
4059 72061	Large	46.40
4059 72071	X-Large	46.40
4059 72081	2X-Large	49.55
4059 72091	3X-Large	49.55
4059 72101	4X-Large	49.55

Hood w/Snaps

> 12 PER CASE.

ITEM NO.	SIZE	EACH
4059 11071	One Size	\$13.50

Pants

> 12 PER CASE.

ITEM NO.	SIZE	EACH
4059 41371	Small	\$41.75
4059 41381	Medium	41.75
4059 41391	Large	41.75
4059 41401	X-Large	41.75
4059 41411	2X-Large	46.20
4059 41421	3X-Large	46.20

Overalls

> 12 PER CASE.

ITEM NO.	SIZE	EACH
4059 03001	Small	\$41.70
4059 03011	Medium	41.70
4059 03021	Large	41.70
4059 03031	X-Large	41.70
4059 03041	2X-Large	45.00
4059 03051	3X-Large	45.00
4059 03061	4X-Large	45.00



Detachable hood.



Raglan sleeve.



Storm fly front.



Premium snap-lock suspender buckles.



Stitched and taped seams.



Heavy-duty suspenders with crossover back.



Contour collar.



RAINWEAR FEATURES/ AND BENEFITS COMPARISON

FEATURE	EAGLE	IRON EAGLE
Material Weight	4.5 oz.	5.5 oz.
Material Thickness	9 mil	10 mil
Full Cut Shoulder with 90° Sleeve to Body Angle		✓
Raglan Sleeve Construction	✓	
Therm-O-Rad Sealed Seams		✓
Stitched Seams	✓	
100% Waterproof Protection	✓	✓
Premium Snap-Lock Suspenders Buckles	✓	✓
Heavy-Duty Suspenders with Crossover		✓
Non-Conductive, Non-Corrosive Snaps	✓	
Mildew Resistant	✓	✓

Iron Eagle® Polyurethane-Coated Nylon Rainsuit

5.5 ounce material weight, 10 mil thick.

- 2 mil exterior polyurethane coating on 200 denier nylon oxford fabric is resistant to abrasions, fats, oils, pine tars, gasoline, grease and a variety of other liquids and chemicals.
- Light-weight/flexible material stays soft and comfortable in cold conditions.
- Slick coating sheds liquids with ease, making this suit easy to clean.
- Heavy-duty snaps are guaranteed not to corrode.
- Therm-O-Rad sealed seams are guaranteed for 100% liquid proof protection, and can withstand extensive laundering.
- Designed to withstand the demands of food processing and sanitation.

TINGLEY



Full cut shoulder with 90° sleeve to body angle.



Detachable hood.



Heavy-duty suspenders with crossover back.

Heavy-duty snaps are guaranteed not to corrode.

Jacket without Hood (includes Hood Snaps)

▶ 12 PER CASE.

GOLD ITEM NO.	GREEN ITEM NO.	BLUE ITEM NO.	SIZE	EACH
4059 02071	4059 22281	4059 22001	Small	\$41.25
4059 02081	4059 22291	4059 22011	Medium	41.25
4059 02091	4059 22301	4059 22021	Large	41.25
4059 02101	4059 22311	4059 22031	X-Large	41.25
4059 02111	4059 22321	4059 22041	2X-Large	45.60
4059 02121	4059 22331	4059 22051	3X-Large	45.60
4059 02131	4059 22341	4059 22061	4X-Large	45.60

Hood with Snaps

▶ 12 PER CASE.

GOLD ITEM NO.	GREEN ITEM NO.	BLUE ITEM NO.	SIZE	EACH
4059 2147	4059 2148	4059 21411	One Size	\$12.95

Jacket with Hood

▶ 12 PER CASE.

GOLD ITEM NO.	GREEN ITEM NO.	SIZE	EACH
4059 21071	4059 2178	Small	\$45.60
4059 21081	4059 2179	Medium	45.60
4059 21091	4059 2180	Large	45.60
4059 21101	4059 2181	X-Large	45.60
4059 21111	4059 2182	2X-Large	47.80
4059 21121	4059 2183	3X-Large	47.80
4059 21131	4059 2184	4X-Large	47.80

Overalls

▶ 12 PER CASE.

GOLD ITEM NO.	GREEN ITEM NO.	BLUE ITEM NO.	SIZE	EACH
4059 20071	4059 23081	4059 73001	Small	\$39.15
4059 20081	4059 23091	4059 73011	Medium	39.15
4059 20091	4059 23101	4059 73021	Large	39.15
4059 20101	4059 23111	4059 73031	X-Large	39.15
4059 20111	4059 23121	4059 73041	2X-Large	42.40
4059 20121	4059 23131	4059 73051	3X-Large	42.40
4059 20131	4059 23141	4059 73061	4X-Large	42.40

Yellow overalls also available in 5X and 6X size. Call for more details.

Yellow jacket with hood also available in XS, 5X and 6X size. Call for more details.

SAFETYFLEX® Acid Suit

TINGLEY

Specially designed for use in food processing areas.

- Heavy exterior coating for excellent permeation performance.
- Non-conductive, non-corrosive snaps.
- Therm-O-Rad sealed seams for 100% liquid proof protection.
- Tapered sleeves are designed to fit in protective gloves or accommodate glove rings for added safety.
- Flame resistant tested. Self extinguishing with flameout and afterglow less than or equal to 2 seconds after removal of ignition source and char length less than 6 inches. Test method ASTM D6413.



Premium snap-lock suspender buckles.



Attached Hood.



Storm fly front seals out wind, rain and contaminants.



Jacket w/Hood

▶ 12 PER CASE.

ITEM NO.	SIZE	EACH
4059 00301	Small	\$26.65
4059 00311	Medium	26.65
4059 00321	Large	26.65
4059 00331	X-Large	26.65
4059 00341	2X-Large	26.65
4059 00351	3X-Large	26.65
4059 00361	4X-Large	26.65

Bib Overall

▶ 12 PER CASE.

ITEM NO.	SIZE	EACH
4059 40151	Medium	\$24.50
4059 40161	Large	24.50
4059 40171	X-Large	24.50
4059 40181	2X-Large	24.50
4059 40191	3X-Large	24.50
4059 40201	4X-Large	43.45

Acid Suits

ONGUARD®

Two suits equipped to protect against a variety of chemical applications.

- Heavy-duty PVC on high count nylon polyester.
- Clear I.D. badge pocket on chest.
- Jacket with storm flap front.
- Cord locks on hood strings.
- Ankle and cuff take-up snaps for a snug/tapered fit.
- Reinforced knees, elbows and crotch area to prevent splitting.
- Heavy-duty elastic adjustable suspender with deluxe suspender clip.
- Adjustable waist snaps for the perfect fit.
- Flame resistance tested to ASTM D6413.
- Color: green.

CHEMTEX* 0.40 mm

Level C protective clothing for protection from a variety of chemical applications.

Jacket

▶ 20 PER CASE.

ITEM NO.	SIZE	EACH
3161 35631	Small	\$60.02
3161 35641	Medium	60.02
3161 35651	Large	60.02
3161 35661	X-Large	60.02
3161 35671	2X-Large	60.02
3161 45531	3X-Large	62.83
3161 45551	4X-Large	65.81

Overalls

▶ 20 PER CASE.

ITEM NO.	SIZE	EACH
3161 35691	Small	\$45.07
3161 35701	Medium	45.07
3161 35711	Large	45.07
3161 35721	X-Large	45.07
3161 35731	2X-Large	45.07
3161 45541	3X-Large	47.19
3161 45561	4X-Large	49.45

Hood

▶ 100 PER CASE.

ITEM NO.	SIZE	EACH
3161 35681	One Size	\$11.98



Chemical- and tear-resistant.



Clear I.D. pocket.



Built-in inner cuffs.



SANITEX 0.35

Specially designed for use in food processing areas.

Jacket

▶ 20 PER CASE.

ITEM NO.	SIZE	EACH
3161 02101	Small	\$37.34
3161 02111	Medium	37.34
3161 02121	Large	37.34
3161 02131	X-Large	37.34
3161 02141	2X-Large	37.34
3161 02151	3X-Large	38.88
3161 02161	4X-Large	40.73
3161 02171	5X-Large	42.58

Overalls

▶ 20 PER CASE.

ITEM NO.	SIZE	EACH
3161 01981	Small	\$33.01
3161 01991	Medium	33.01
3161 02001	Large	33.01
3161 02011	X-Large	33.01
3161 02021	2X-Large	33.01
3161 02031	3X-Large	34.65
3161 02041	4X-Large	36.30
3161 02051	5X-Large	33.01

Hood

▶ 100 PER CASE.

ITEM NO.	SIZE	EACH
3161 12601	One Size	\$4.84

*Level protection should be used when the atmospheric contaminants, liquid splashes, or other direct contact will not adversely affect or be absorbed through any exposed skin (not to be used in Level A environments).

0.16 mm Impertech™ Sanitation Bib

Chemical and mildew resistant.

- 0.16 mm circular knit polyester backing with stretch polyurethane coating.
- High waist bib pant with elastic at ankles.
- Adjustable elastic suspenders.
- Chest pocket with hook and loop closure on right side.
- Snap adjustment at hem and waist.
- MicroWeld® seam construction.
- Blood borne pathogen tested.
- Color: Navy blue.



▶ 10 PER CASE.

ITEM NO.	PRODUCT	EACH
6417 05901	X-Small	\$67.85
6417 05911	Small	67.85
6417 05921	Medium	67.85
6417 05931	Large	67.85
6417 05941	X-Large	67.85
6417 05951	2X-Large	67.85
6417 05961	3X-Large	69.56

0.16 mm Impertech™ Sanitation Jacket with Hood

Super tough yet comfortable.

- 0.16 mm circular knit polyester backing with stretch polyurethane coating.
- Elastic on wrists and hood for snug fit.
 - Back cape for ventilation.
 - MicroWeld® seam construction.
- Generously cut with raglan sleeves.
 - Front zip with snap storm flap.
 - Over flap front closure with plastic snaps.
- Blood borne pathogen tested. • Color: Navy blue.



▶ 10 PER CASE.

ITEM NO.	PRODUCT	EACH
6417 03171	X-Small	\$67.85
6417 03181	Small	67.85
6417 03191	Medium	67.85
6417 03201	Large	67.85
6417 03211	X-Large	67.85
6417 03221	2X-Large	67.85
6417 03231	3X-Large	69.56

0.35 mm Mandal Jacket and Bib

Chemical and mildew resistant.

- PVC on a durable polyester scrim backing. • Extreme weather protection.
- Jacket has drawcord hood and storm flap with snap closure.
- Bibs have symmetrical cut on front and back. • Take-up snap at waist.
- Heavy-duty attached suspenders and click-type connectors.



▶ 10 PER CASE.

Jacket

YELLOW ITEM NO.	ORANGE ITEM NO.	WHITE ITEM NO.	DARKGREEN ITEM NO.	SIZE	EACH
6417 02111	---	6417 25001	6417 14801	X-Small	\$47.16
6417 02121	6417 02321	6417 25011	6417 14811	Small	47.16
6417 02131	6417 02331	6417 25021	6417 14821	Medium	47.16
6417 02141	6417 02341	6417 25031	6417 14831	Large	47.16
6417 02151	6417 02351	6417 25041	6417 14841	X-Large	47.16
6417 02161	6417 02361	6417 25051	6417 14851	2X-Large	47.16
6417 02171	6417 02371	6417 25061	6417 14861	3X-Large	48.83

Bib

YELLOW ITEM NO.	ORANGE ITEM NO.	WHITE ITEM NO.	DARKGREEN ITEM NO.	SIZE	EACH
6417 13101	---	---	6417 04801	X-Small	\$47.16
6417 13111	6417 13211	6417 13311	6417 04811	Small	47.16
6417 13121	6417 13221	6417 13321	6417 04821	Medium	47.16
6417 13131	6417 13231	6417 13331	6417 04831	Large	47.16
6417 13141	6417 13241	6417 13341	6417 04841	X-Large	47.16
6417 13151	6417 13251	6417 13351	6417 04851	2X-Large	47.16
6417 13161	6417 13261	6417 13361	6417 04861	3X-Large	48.83



WARNING:

Some products in this catalog may expose you to chemicals including DEHP Di (2-ethylhexyl) phthalate or BPA (Bisphenol A) which are known to the State of California to cause cancer or birth defects or other reproductive harm. For more information, visit www.P65Warnings.ca.gov.



**Look for the Vikan® logo
for a Complete line of
Color-Coded Products.**



**Hygienic cleaning tools designed
to minimize the risk of
cross-contamination.**

**▶ LOOK FOR A HUGE
SELECTION OF VIKAN®
HYGIENIC CLEANING TOOLS
THROUGHOUT THIS SECTION.**



CLEANING/HYGIENE

FIND IT FAST

Color-Coded Brushes	96-103
Bottle, Floor Drain and Specialty Brushes	102-103
Squeegees	104-107
Tool Holders and Organizers	108
Scrapers	109
Handles	110-111
Brooms, Sweeps and Dust Pans	112-115
Dust Mops, Mops and Accessories	116-123
Sponge Mops, Sponges and Ceiling Scrubbers	122-123
Flo-Thru and Floor Brushes	124-126
Cleaning and Scouring Pads	127-128
Rags and Rag Replacement System	129-131
Chemical Dispensing System and Chemical Info	132-133
Production Area Cleaners	134
Sanitizers, Disinfectants, Degreasers and Cleaners	135-144
Spray Bottles, Pumps, Boot Dip Mat and Caddy	145
Nozzles, Adapters and Accessories	146-151
Hoses and Mixing Stations	152-154
High-Pressure Nozzles, Washers and Accessories	155-156
Foamers and Sanitizing Systems	157-160
Sanitizers, Wipes, Soaps and Dispensers	161-167
Dispensers and Accessories	168-169
Lavs, Sinks and Accessories	170-177
Knife Sterilizers and Heaters	178-179
Paper Towels, Tissue and Dispensers	180-183
Ozone Machines	183
Restroom Supplies and Cleaners	182-185



Vikan® Total Color Round Hand Brush

The perfect scrub brush to fit securely in your hand!

- 5-inch diameter brush made with stiff 44 mm bristles.
- Block and bristles are made from the same color.
- Made from FDA-compliant materials.

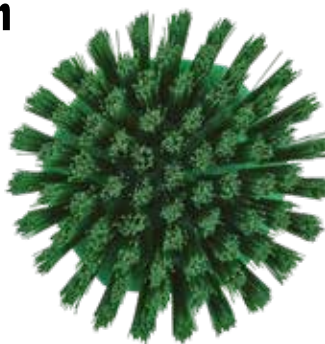

ITEM NO.	COLOR
5281 8855	White
5281 88541	Red
5281 8856	Yellow
5281 8852	Green
5281 8853	Blue

EACH
\$18.95



Vikan® Tank Brushes

- Multi-directional bristles are angled and cut to create an oval-shaped head to clean curved surfaces.
- The rounded edges work well to clean down the sides of equipment.

NOTE: Requires a European-thread handle, sold separately.

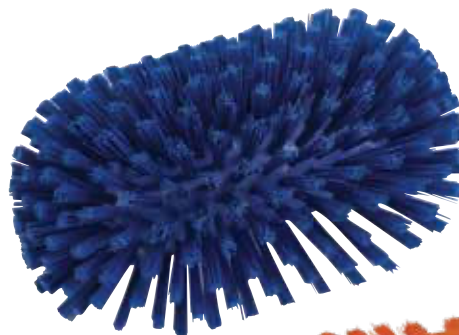

Stiff Bristle

5-1/2 inches W x 8 inches H

ITEM NO.	COLOR
5281 03721	Green
5281 03731	Blue
5281 03741	Red
5281 03751	White
5281 03761	Yellow
5281 03771	Orange
5281 03781	Purple
5281 03791	Black
H710 00291	Pink
5281 04221	Brown
5281 04231	Lime
5281 04241	Gray

EACH
\$36.95

Medium Bristle

5-1/2 inches W x 8 inches H

ITEM NO.	COLOR
5281 03921	Green
5281 02041	Blue
H710 00031	Red
5281 03951	White
5281 03961	Yellow

EACH
\$24.32

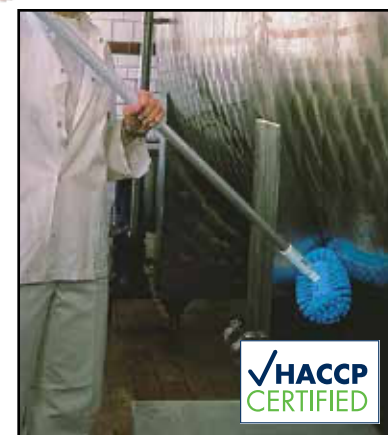

▶ SEE PAGE 111
For Vikan® Handles

If it doesn't work, it isn't Vikan®



Vikan® Total Color Bench Brush

Colored brushes help eliminate cross-contamination.

- Block and bristles are made from the same color.
- Made from FDA-compliant materials.



Soft Bristle

ITEM NO.	COLOR
5281 50751	White
5281 50741	Red
5281 50761	Yellow
5281 50721	Green
5281 50731	Blue
5281 58771	Orange
5281 58781	Purple
5281 50791	Black
5281 04041	Pink
5281 04061	Brown
5281 04071	Lime
5281 04081	Gray

EACH
\$12.66

Medium Bristle

ITEM NO.	COLOR
5281 58951	White
5281 58941	Red
5281 58961	Yellow
5281 58921	Green
5281 58931	Blue
5281 58971	Orange
5281 58981	Purple
5281 58991	Black
5281 03201	Pink
5281 04101	Brown
5281 04181	Lime
5281 04191	Gray

EACH
\$12.66



Scan this QR code with your mobile device to watch a video about Vikan® color-coded brush usage.



Vikan® Stiff Bristle Tube Brushes

Tough polypropylene blocks and polyester bristles are suitable for food processing environments.

- Made with low water absorption polyester bristles.
- Made from FDA-compliant materials.

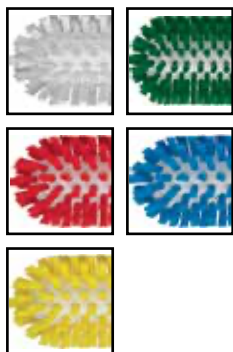

NOTE: Requires a European-thread handle, sold separately.

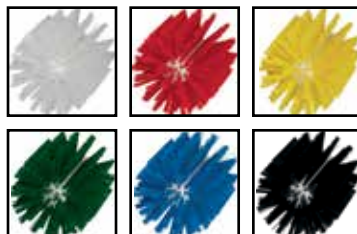

Stiff Bristle

2 inches x 5-3/4 inches

ITEM NO.	COLOR
5281 39051	White
5281 39041	Red
5281 39061	Yellow
5281 39021	Green
5281 39031	Blue

EACH
\$20.85

Stiff Bristle

4 inches x 6-1/2 inches

ITEM NO.	COLOR
5281 39471	White
5281 39441	Red
5281 39461	Yellow
5281 39421	Green
5281 3943	Blue
5281 39481	Black

EACH
\$23.05

▶ SEE PAGE 111 For Vikan® Handles

Vikan® 6-1/2-Inch Mini Handle



For use with tube brushes shown to left.

- Made from FDA-compliant materials.
- Ideal for those jobs in small places.
- Rounded grooves on handle improve grip without compromising hygiene.

ITEM NO.	COLOR
5281 93451	White
5281 93431	Blue
5281 93461	Yellow
5281 93421	Green
5281 9344	Red

EACH
\$8.42



Vikan® Scrub Brushes

Choose from three styles and multiple colors.

- Low water absorption polyester bristles with stainless steel staples.
- Hygienic, solid block polypropylene construction.
- Autoclavable at temperatures up to 250 °F/121 °C.
- Made from FDA-compliant materials.



Ergonomic shape for easy gripping.



Scrub Brush, Stiff

2-1/2 inches x 7-1/2 inches

ITEM NO.	COLOR
5281 89051	White
5281 89041	Red
5281 89061	Yellow
5281 89021	Green
5281 89031	Blue
5281 89071	Orange
5281 89081	Purple
5281 89091	Black

EACH
\$15.84



Scan this QR code with your mobile device to watch a video about Vikan® color-coded brush usage.

Vikan® Short Handle Scrub Brush



Stiff Bristle

3 inches x 10 inches

ITEM NO.	COLOR
5281 19251	White
5281 19241	Red
5281 19261	Yellow
5281 19221	Green
5281 19231	Blue
5281 19271	Orange
5281 19281	Purple
5281 19291	Black
5281 04011	Pink
5281 04021	Brown
5281 03311	Lime
5281 04031	Gray

EACH
\$13.72



Vikan® Long Handle Scrub Brush



Stiff Bristle

2-3/4 inches x 15-3/4 inches

ITEM NO.	COLOR
5281 18651	White
5281 18641	Red
5281 18661	Yellow
5281 18621	Green
5281 18631	Blue

EACH
\$14.79

If it doesn't work, it isn't Vikan®



VIKAN® COLOR-CODED BRUSHES

Vikan® Ultra Safe Technology (UST) Scrub Brushes

UST provides a new level of hygienic design and bristle arrangement.

- Easy to clean and dry.
- Easy color-coded visual inspection.
- One piece design, no metal staples or resin.



Long Handle

ITEM NO.	COLOR
5281 00431	Pink
5281 00441	Green
5281 00451	Blue
5281 00461	Red
5281 00471	White
5281 00481	Yellow
5281 19671	Orange
5281 00491	Purple

EACH
\$27.50



Short Handle

ITEM NO.	COLOR
5281 00381	Pink
5281 00281	Green
5281 00391	Blue
5281 00291	Red
5281 00301	White
5281 00311	Yellow
5281 00401	Orange
5281 00411	Purple

EACH
\$22.20

Easy-to-clean
bristle
arrangement.



THE INNOVATIVE ULTRA SAFE TECHNOLOGY (UST) Utilizes enhanced bristle security units directly molded to the brush block, removing any gaps or seams while offering unprecedented bristle retention strength.

Vikan® Ultra Safe Technology (UST) Bench Brushes

Easy to clean bristle arrangement.

- Colored brushes help eliminate cross contamination.
- Block and bristles are made from the same color.
- Made from FDA-compliant materials.



Soft Bristle

ITEM NO.	COLOR
5281 00501	Pink
5281 00511	Green
5281 00521	Blue
5281 00541	Red
5281 00551	White
5281 00561	Yellow
5281 00571	Orange
5281 00581	Purple

EACH
\$24.33

Medium Bristle

ITEM NO.	COLOR
5281 00591	Pink
5281 00601	Green
5281 00611	Blue
5281 00621	Red
5281 00631	White
5281 00641	Yellow
5281 00651	Orange
5281 00661	Purple

EACH
\$24.33





Develop a safe, reliable HACCP cleaning program with **SPARTA® COLOR-CODED PRODUCTS.**



Sparta® 6-Inch Polyester Bake Pan Lip Brush

- Polybutylene bristles are non-absorbent and keep their shape for better scrubbing and longer bristle life.
- Foam-injected plastic block for extra strength.
- Bristle trim: 1-1/4 inches.
- Temperature range: -40° to 125 °F.
- Ergonomic grip. • FDA-compliant.



ITEM NO.	COLOR	ITEM NO.	COLOR
6387 21371	Red	6387 21391	White
6387 21321	Orange	6387 20981	Gray
6387 21411	Yellow	6387 20921	Black
6387 21311	Lime	6387 20971	Brown
6387 20991	Green		
6387 20931	Blue		
6387 21361	Purple		
6387 21351	Pink		
6387 21381	Tan		

▶ 12 PER CASE.
EACH
\$10.04

Sparta® 6-Inch Hand Scrub Brush

- Polybutylene bristles are non-absorbent and keep their shape for better scrubbing and longer bristle life.
- Foam injected plastic block for extra strength.
- Bristle trim: 1-3/20 inches. • Temperature range: -40° to 125 °F.
- Ergonomic grip. • FDA-compliant.



ITEM NO.	COLOR
6387 21521	Red
6387 21491	Orange
6387 21561	Yellow
6387 21481	Lime
6387 21471	Green
6387 21441	Blue
6387 21511	Purple
6387 21501	Pink
6387 21531	Tan
6387 21551	White
6387 21461	Gray
6387 21431	Black
6387 21451	Brown

▶ 12 PER CASE.
EACH
\$12.34



Sparta® Floater Scrub Brushes

Tough, durable and economical brushes that are perfect for a multitude of clean-up chores.

- Polybutylene bristles keep their shape for better scrubbing and longer life.
- Bristles will not absorb oils or moisture. • Bristle trim: 1-3/4 inches.
- Foam injected plastic blocks for added strength.
- Temperature range: -40° to 125 °F. • FDA-compliant.

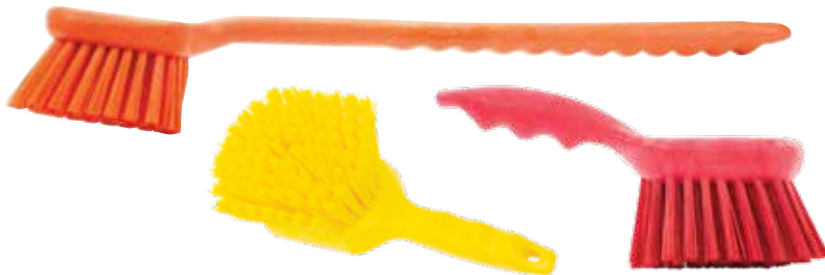

8-Inch Short Handle

ITEM NO.	COLOR
6387 21901	Red
6387 21871	Orange
6387 21931	Yellow
6387 21861	Lime
6387 21851	Green
6387 21821	Blue
6387 21891	Purple
6387 21881	Pink
6387 21911	Tan
6387 21921	White
6387 21841	Gray
6387 21811	Black
6387 21831	Brown

▶ 12 PER CASE.
EACH
\$12.05

20-Inch Long Handle

ITEM NO.	COLOR
6387 20281	Red
6387 20241	Orange
6387 20331	Yellow
6387 20221	Lime
6387 20211	Green
6387 19641	Blue
6387 20271	Purple
6387 20261	Pink
6387 20301	Tan
6387 20311	White
6387 19621	Black
6387 19681	Brown

▶ 12 PER CASE.
EACH
\$18.72



Sparta® 8-Inch Counter/Bench Brush

- Efficiently sweeps dust and debris from counters and other surfaces.
- Foam injected block provides additional durability.
- Polybutylene bristles are non-absorbent and keep their shape for longer bristle life.
- FDA-compliant.



▶ SEE PAGE 108
For Brush Racks

ITEM NO.	COLOR
6387 21991	Red
6387 21771	Orange
6387 22311	Yellow
6387 21751	Lime
6387 21981	Green
6387 21971	Blue
6387 21791	Purple
6387 21781	Pink
6387 21801	Tan

ITEM NO.	COLOR
6387 21941	White
6387 21741	Gray
6387 21721	Black
6387 21731	Brown

▶ 12 PER CASE.
EACH
\$14.54





Develop a safe, reliable HACCP cleaning program with **SPARTA® COLOR-CODED PRODUCTS.**



CARLISLE SPARTA® COLOR-CODED BRUSHES

Sparta® Tank and Kettle Brush

- Flared head ensures all-around thorough cleaning.
- Crimped, non-absorbent polyester bristles are stapled into the block for increased durability.
- Foam-injected plastic block provides additional durability.
- Bristle trim: 1-3/4 inches. • Temperature range: -40° to 125 °F.
- FDA-compliant.



▶ SEE PAGE 110 For Handles

Large

5-1/2 Inches x 9-1/2 Inches

ITEM NO.	COLOR
6387 20741	Red
6387 20711	Orange
6387 20771	Yellow
6387 20701	Lime
6387 20691	Green
6387 20661	Blue
6387 20731	Purple
6387 20721	Pink
6387 20751	Tan
6387 20761	White
6387 20681	Gray
6387 20651	Black
6387 20671	Brown

▶ 12 PER CASE.

EACH
\$41.84

Small

5-1/4 Inches x 7-1/2 Inches

ITEM NO.	COLOR
6387 20881	Red
6387 20851	Orange
6387 20901	Yellow
6387 20841	Lime
6387 20831	Green
6387 20801	Blue
6387 20871	Purple
6387 20861	Pink
6387 20891	Tan
6387 20791	White
6387 20821	Gray
6387 20781	Black
6387 20811	Brown

▶ 12 PER CASE.

EACH
\$39.64



Sparta® 9-Inch Tile and Grout Brush

- Brush can be handheld or used with a threaded handle (sold separately).
- Two-position handle holes for effectively removing stubborn stains from grouted tile.
- Polybutylene bristles are non-absorbent and keep their shape for longer bristle life.
- Foam injected block provides additional durability.
- Molded-in scraper. • Bristle trim: 1 inch.
- Temperature range: -40° to 125 °F. • FDA-compliant.

ITEM NO.	COLOR
6387 22461	Red
6387 22421	Orange
6387 22491	Yellow
6387 22411	Lime
6387 22391	Green
6387 22331	Blue
6387 22451	Purple
6387 22441	Pink
6387 22471	Tan
6387 22481	White
6387 22381	Gray
6387 22321	Black
6387 22341	Brown

▶ 12 PER CASE.

EACH
\$11.19



Sparta® Valve and Fitting Brush

- Versatile for cleaning equipment that needs a rounded cleaning utensil, such as kettles, vats and tanks.
- Rounded heads and ends protect against scratching and clean in all directions. • Diameter: 3-1/2 inches.
- Resins used to produce blocks and bristles are made of FDA-compliant materials. • Available in 5 colors.



16 Inch

ITEM NO.	COLOR
6387 02021	White
6387 18181	Red
6387 16751	Yellow
6387 17841	Green
6387 18391	Blue

▶ 6 PER CASE.

EACH
\$36.38

30 Inch

ITEM NO.	COLOR
6387 03021	White
6387 18491	Red
6387 18441	Yellow
6387 18501	Green
6387 18511	Blue

▶ 6 PER CASE.

EACH
\$37.43



Sparta® Valve and Fitting Brush with Polyester Bristles



- 15-inch straight brush with stiff polyester bristles in galvanized wire with plastic handle.
- Designed for cleaning straight pipes, elbows, tees and valves.
- Made with FDA-compliant block and bristles.
- Bristles withstand temperatures up to 125 °F.

▶ 12 PER CASE.

ITEM NO.	PRODUCT	EACH
6387 40211	1" Diameter Brush	\$11.28

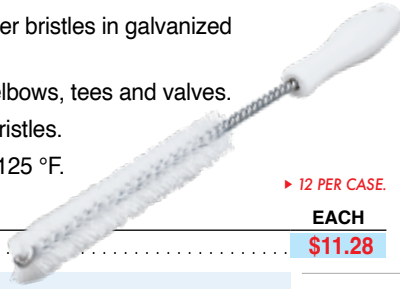

Sparta® Handle Quart Bottle Brush with Polyester Bristles

- Base resins used to produce blocks and bristles are made of FDA-compliant materials.
- 16-inch all plastic handle.



▶ 12 PER CASE.

ITEM NO.	PRODUCT	EACH
6387 40461	Quart Bottle Brush	\$31.45



Vikan® Bottle Brushes, Stiff/Extra Stiff



Hygienic one-piece construction removes a joint common in this type of brush that often harbors contaminants.



- Extra-stiff bristles at the front of the brush enable quick and effective cleaning of the surface.
- Large, easy-to-clean drop-shaped hanging hole
- One color from bristles to block.
- 3-1/2 inches W x 16-9/10 inches L x 3-1/2 inches H.



ITEM NO.	COLOR	EACH
H710 00081	Red	\$20.08
5281 03971	Orange	
H710 00061	Yellow	
5281 01551	Green	
H710 00091	Blue	
5281 03991	Purple	
H710 00051	Black	
H710 00071	White	

Sparta® Polyester Bottle Brush



- Soft bristles and small diameter handle for delicate cleaning of jars, bottles and glasses with smaller openings.
- Polypropylene handle with polyester bristles.
- FDA-compliant. • BPA free.



12-Inch

Bristle trim: 1-1/4 inches

ITEM NO.	COLOR	EACH
6387 15981	Red	\$13.60
6387 23641	Orange	
6387 16081	Yellow	
6387 23681	Lime	
6387 23621	Green	
6387 23521	Blue	
6387 23671	Purple	
6387 23661	Pink	
6387 23651	Tan	
6387 23361	White	
6387 23631	Gray	
6387 23611	Black	
6387 23601	Brown	



16-Inch

Bristle trim: 3-1/4 inches

ITEM NO.	COLOR	EACH
6387 19381	Red	\$17.59
6387 19351	Orange	
6387 19411	Yellow	
6387 19341	Lime	
6387 19331	Green	
6387 19671	Blue	
6387 19371	Purple	
6387 19361	Pink	
6387 19391	Tan	
6387 19651	White	
6387 19321	Gray	
6387 19631	Black	
6387 19691	Brown	



Floor Drain Brush

Handle and brush utilize reverse threading, so the brush and handle cannot be used with other handles or brushes, preventing cross contamination.

- Long-lasting polypropylene bristles stand up to rugged usage.
- Brush head available in three diameters: 3, 4 or 6 inches.
- Choose from two handle lengths: 36 or 48 inches, both with 1 inch diameter.
- Handles and brushes are interchangeable and sold separately.



Handle has female thread.
Brush head has male thread.

▶ 6 BRUSHES PER CASE.

ITEM NO.	PRODUCT	EACH
6387 46001	3" Brush Head	\$23.26
6387 45991	4" Brush Head	23.26
6387 48001	6" Brush Head	27.35

▶ 12 HANDLES PER CASE.

ITEM NO.	PRODUCT	EACH
6387 46011	36" Plastic Handle	\$26.09
6387 37001	48" Plastic Handle	26.41



Handle labeled in English and Spanish.

Vikan® Detail Brush

Small compact hand brush suitable for cleaning in and around gaskets, rubber strips and joints on machinery.

- Extra-stiff and angled bristles.
- 1/2-inch wide brush head allows access to narrow spaces.
- Drop-shaped hole is large and easy-to-clean.
- 1/2 inch W x 7-9/10 inches L x 9/10 inches H.



ITEM NO.	COLOR
5281 01611	Yellow
5281 03371	Green
5281 03501	Red
5281 03511	Orange
5281 03521	Purple
5281 03541	Lime
5281 40151	White
H710 00811	Blue



EACH
\$7.36

Vikan® Hook Brush

Cleaning between and around pipes made easy.

- Brush bristles are secured with stainless steel wires.
- Recessed threaded handle allows for another handle to connect and extend the reach of the brush.
- One color from bristles to block.
- 2-1/4 inches W x 15-1/2 inches L x 7-3/5 inches H.
- Materials are FDA-compliant.



ITEM NO.	COLOR
5281 01511	Red
5281 01701	White
5281 03211	Yellow
H710 00581	Blue
H710 02741	Green
5281 03551	Orange
5281 03221	Black



EACH
\$18.64

Flagged Counter Brush



Ideal for fine particles, dust and sawdust on smooth surfaces.

- Brush head constructed of sturdy foam plastic with bidirectional hanging hole.
- 13-inch block with 8-inch long brush face and 2-1/2-inch trim.



▶ 12 PER CASE.

ITEM NO.	PRODUCT	EACH
6387 05671	Counter Brush	\$9.92

Vikan® Hygienic Special Application Brushes

Designed for a wide range of applications in hard-to-reach areas.

- Fully adjustable for cleaning top and bottom of pipes.
- Helically wound stainless steel shaft.
- Polyester bristles.



▶ SEE PAGE 111
For Available Handles

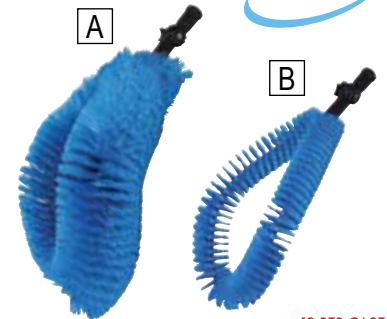

▶ 12 PER CASE.

ITEM NO.	PRODUCT	SIZE	EACH
5281 37131	A. Soft Brush	4-2/5" x 20"	\$46.15
5281 37441	B. Stiff Brush	2-1/2" x 20"	46.15

Stainless Steel Utility Brushes

Ideal for removing grease and deposits from small and tight areas.

- Stainless steel bristles allow for aggressive removal of grease.
- Blue plastic handle.



A



Built-in scraper.



ITEM NO.	PRODUCT	EACH
6387 00501	A. 11-1/2" Utility Brush w/Scraper	\$14.65
6387 67111	B. 11-1/2" Utility Brush w/o Scraper	10.02

Toothbrush-Style Utility Brushes

Ideal for cleaning tight, small areas.

- Great for small jobs, tight areas and detail work, small parts, seams, threads, and soldered joints.
- 7-inch plastic handle.



▶ 12 PER CASE.

ITEM NO.	PRODUCT	EACH
6387 74011	A. Nylon Bristles	\$4.46
6387 12701	B. Brass Bristles	4.37
6387 06331	C. Stainless Steel Bristles	4.37

Vikan® One-Piece Ultra Hygiene Squeegees

- One-piece design and co-molded construction eliminates risk of bacteria.
- Specially blended rubber blade retains its flexibility and durability and is useful on a variety of work surfaces.
- Reinforced polypropylene head. • Made from FDA-compliant materials.



Scan this QR code with your mobile device to watch a video about Vikan® squeegees.

▶ SEE PAGE 111 Vikan® Handles Sold Separately.



10-inch squeegee includes a matching 6.3-inch threaded Vikan® mini handle with a one-piece sealed-design.

GREEN	BLUE	RED	WHITE	YELLOW	ORANGE	BLACK	PURPLE	PINK	BROWN	LIME	GRAY	▶ 15 PER CASE.	
ITEM NO.	ITEM NO.	ITEM NO.	ITEM NO.	ITEM NO.	ITEM NO.	ITEM NO.	ITEM NO.	ITEM NO.	ITEM NO.	ITEM NO.	ITEM NO.	PRODUCT	EACH
5281 07401	5281 12531	5281 07421	5281 12551	5281 07441	5281 07451	---	5281 12581	5281 03191	---	---	---	10 Inch. . .	\$22.20
5281 07461	5281 07471	5281 07481	5281 07491	5281 07501	5281 03481	5281 01251	5281 01811	5281 14011	5281 04261	5281 04271	5281 04341	16 Inch. . .	30.69
5281 07511	5281 07521	5281 07531	5281 07541	5281 07551	---	---	---	---	---	---	---	20 Inch. . .	39.00
5281 07681	5281 07571	5281 07581	5281 07591	5281 07601	5281 16071	5281 07621	5281 07611	5281 02451	H710 00761	5281 04281	H710 00851	24 Inch. . .	39.17
5281 07631	5281 07641	5281 07651	5281 07661	5281 07671	---	---	---	---	---	---	---	28 Inch. . .	44.46

Vikan® Double Blade Ultra Hygiene Squeegees

- Durable, molded head with removable double blades.
- Autoclavable at temperatures up to 250 °F/121 °C.



GREEN	BLUE	RED	WHITE	YELLOW	ORANGE	BLACK	PURPLE	PINK	▶ 10 PER CASE.	
ITEM NO.	ITEM NO.	ITEM NO.	ITEM NO.	ITEM NO.	ITEM NO.	ITEM NO.	ITEM NO.	ITEM NO.	PRODUCT	EACH
5281 71321	5281 71331	5281 71341	5281 71351	5281 71371	---	---	---	---	20 Inch.	\$32.80
5281 71421	5281 71431	5281 71501	5281 71451	5281 71461	5281 71471	5281 71491	5281 71481	H710 00441	24 Inch.	38.11
5281 00991	5281 01051	5281 71541	5281 00981	5281 01011	---	---	---	---	28 Inch.	45.53

Vikan® Ultra Hygiene Poly Handles

- Made of food-grade polypropylene a safe alternative to fiberglass.
- Easy to clean rounded grip handles.
- Hygienic smooth surface, sealed to prevent bacterial growth.
- Larger diameter ergonomic handle shape reduces worker fatigue.



Hygienic design with smooth surface, sealed to prevent bacterial growth.

Euro thread.



GREEN	BLUE	RED	WHITE	YELLOW	ORANGE	BLACK	PURPLE	PINK	BROWN	LIME	GRAY	▶ 10 PER CASE.	
ITEM NO.	ITEM NO.	ITEM NO.	ITEM NO.	ITEM NO.	ITEM NO.	ITEM NO.	ITEM NO.	ITEM NO.	ITEM NO.	ITEM NO.	ITEM NO.	PRODUCT	EACH
5281 86021	5281 86031	5281 16041	5281 86051	5281 96061	5281 86071	5281 96091	5281 96081	5281 96011	---	---	---	51 Inch.	\$30.70
5281 86221	5281 16231	5281 16241	5281 96301	5281 96321	5281 86271	5281 96311	5281 86281	5281 96211	H710 00991	5281 03351	5281 04291	59 Inch.	30.70

Vikan® 10-Inch Fixed Head Bench Squeegees



- Durable, molded head with screw-in handle and replaceable double blades.
- Double splash guard for push or pull applications.
- Dense white foam blades held in place with locking cassette.
- Includes 6-1/2-inch one-piece sealed design threaded handle.



Easy to replace refill blades with special finger grip.

▶ SEE PAGE 111
Longer Handles Sold Separately.

ITEM NO.	PRODUCT	EACH
5281 7677	Yellow	\$12.68
5281 75271	White	12.68
5281 7672	Green	12.68
5281 75241	Red	12.68
5281 75171	Blue	12.68

Vikan® 24-Inch Swivel Neck Foam Squeegees



- Easy to remove blade cartridges for increased efficiency and improved hygiene.
- Swivel neck provides the flexibility to clean narrow and hard-to-reach areas.
- Blade retains its durability and is useful on a variety of work surfaces.
- Polypropylene head.

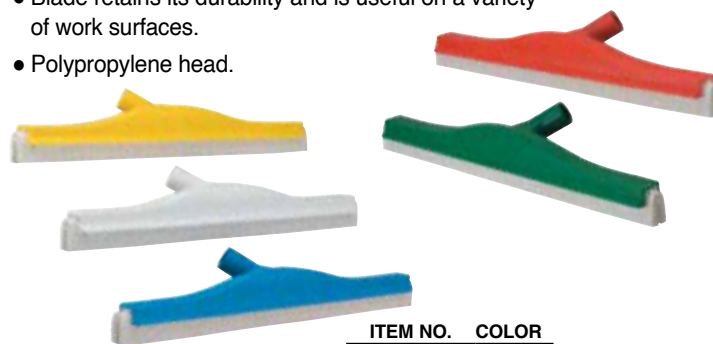

▶ SEE PAGE 111
Handles Sold Separately.

ITEM NO.	COLOR	EACH
5281 76441	Red	▶ 10 PER CASE. EACH \$56.13
5281 05291	Green	
5281 05311	Yellow	
5281 00071	White	
5281 05301	Blue	

Vikan® Fixed Head Foam Squeegees

- Effective at removing water and debris from all types of flooring.
- Choose from 16-, 20-, 24- or 28-inch polypropylene head with black foam blade.



▶ SEE PAGE 111
Must Be Used With Vikan® Handles, Sold Separately.



GREEN	BLUE	RED	WHITE	YELLOW	ORANGE	BLACK	PURPLE	PINK	BROWN	LIME	GRAY	PRODUCT	EACH
5281 03571	5281 75291	5281 75281	5281 75251	5281 03581	---	---	---	---	---	---	---	16 Inch.	\$27.50
5281 08221	5281 08231	5281 08241	5281 75351	5281 08361	---	5281 75391	---	---	---	---	---	20 Inch.	29.62
5281 75421	5281 75431	5281 75441	5281 00031	5281 75461	5281 75471	5281 75491	5281 75481	5281 04331	5281 04351	5281 03331	5281 04361	24 Inch.	31.74
5281 77581	5281 77571	5281 77511	5281 77551	5281 75561	---	---	---	---	---	---	---	28 Inch.	39.17

Vikan® Replacement Foam Blades, White

▶ 20 PER CASE.

ITEM NO.	PRODUCT	EACH
5281 77151	10" Repl. Blade	\$7.95
5281 77251	16" Repl. Blade	13.75
5281 77351	20" Repl. Blade	14.75
5281 77471	24" Repl. Blade	16.65
5281 05801	28" Repl. Blade	21.95



Easy to replace refill blades with finger grips.

Vikan® Replacement Foam Blades, Black

▶ 20 PER CASE.

ITEM NO.	PRODUCT	EACH
5281 77291	16" Repl. Blade, Black	\$12.67
5281 77391	20" Repl. Blade	14.78
5281 77491	24" Repl. Blade	16.48
5281 77591	28" Repl. Blade	19.03



Easy to replace refill blades with finger grips.



Develop a safe, reliable HACCP cleaning program with
SPARTA® COLOR-CODED PRODUCTS.



Sparta® Double Foam 24-Inch Color-Coded Squeegees

- All plastic construction will not rust and is safe to use on delicate tile and marble floors.
- Closed cell double foam blades ensures against bacteria growth.
- Available in 7 HACCP-compliant colors.

ITEM NO.	COLOR
6387 68721	Purple
6387 08091	Green
6387 08051	Red
6387 08141	Blue
6387 08021	White
6387 68261	Orange
6387 08041	Yellow

▶ 6 PER CASE.

EACH

\$35.96

**NOTE: We recommend using
Sparta® Fiberglass Handles.
SEE BELOW.**



Sparta® 3/4-Inch ACME Threaded Fiberglass Handles

- Polyester veil prevents fiberglass surface from splintering.
- Withstands forces up to 250 pounds.
- Hanging cap keeps the handle off the ground and organized.
- Designed for use with Sparta push brooms, sweeps, squeegees and floor scrubs.



48 Inch

ITEM NO.	COLOR
6387 20561	Red
6387 20611	Orange
6387 20581	Yellow
6387 20601	Lime
6387 20551	Green
6387 20531	Blue
6387 20631	Purple
6387 20621	Pink
6387 20641	Tan
6387 20571	White
6387 20591	Gray
6387 20521	Black
6387 20541	Brown

▶ 12 PER CASE.

EACH

\$18.74

60 Inch

ITEM NO.	COLOR
6387 21621	Red
6387 21671	Orange
6387 21641	Yellow
6387 21661	Lime
6387 21611	Green
6387 21591	Blue
6387 21691	Purple
6387 21681	Pink
6387 21701	Tan
6387 21631	White
6387 21651	Gray
6387 21581	Black
6387 21601	Brown

▶ 12 PER CASE.

EACH

\$20.82

One-Piece 24-Inch Color-Coded Squeegees

One-piece design minimizes possible contamination areas that can harbor dirt and bacteria.

- Squeegee will not rust and is safe to use on delicate tile and marble floors.
- Available in 8 colors.

ITEM NO.	COLOR	ITEM NO.	COLOR
6387 68701	Purple	6387 68021	White
6387 68041	Yellow	6387 28141	Blue
6387 68091	Green	6387 28031	Black
6387 68051	Red	6387 68251	Orange

▶ 6 PER CASE.

EACH

\$32.95



NOTE: We recommend using Sparta® Fiberglass Handles. SEE ABOVE.

Economy Industrial Plastic Squeegees

- Light-weight, non-marking rustproof squeegees.
- Double-edged, sponge rubber blades are fat and oil resistant.
- The flexible blades conform to irregular and uneven surfaces, making them perfect for smooth, grouted and uneven floors.
- Plastic squeegee with bristles contains fused plastic bristles for greater agitation ability.

► SEE PAGE 106
We recommend Sparta® 3/4-Inch ACME Threaded Handle sold separately.



Squeegees

► 10 PER CASE.

ITEM NO.	PRODUCT	EACH
6387 07151	18" Blade.....	\$13.19
6387 07371	22" Blade.....	17.75
6387 07161	30" Blade.....	22.86
6387 18061	18" Blade w/Bristles.....	27.35



Industrial Quality Squeegees

- Made from heavy-duty, long-lasting, zinc-plated metal.
- Features a 2-inch non-marking gum rubber blade.
- Curved blade offers greater control of a larger volume of water.



► 6 PER CASE.

ITEM NO.	PRODUCT	EACH
1770 19321	A. 24" Straight Blade.....	\$43.85
1770 99341	B. 24" Curved Blade.....	43.85

► 12 PER CASE.

ITEM NO.	PRODUCT	EACH
6387 41231	60" Tapered Plastic Handle.....	\$25.99

Foam Rubber Moss Squeegee, 30 Inches

- Durable black foam rubber blade.
- Reinforced metal frame.



► 6 PER CASE.

ITEM NO.	PRODUCT	EACH
6387 07081	30" Foam Rubber Moss Squeegee.....	\$24.94

► 12 PER CASE.

ITEM NO.	PRODUCT	EACH
6387 06411	60" Tapered Wood Handle.....	\$6.24

NEED ASSISTANCE?



Our experienced customer service representatives are available to answer your questions, find the products you are looking for, check product availability, as well as take your order.

800-456-5624

Rack 'Em™ Brush Racks

- Color-coded rack reduces the spread of bacteria.
- Holds brushes, brooms, scrapers, scoops, shovels, mops and squeegees on 2-1/2 inch long hooks.
- One inch spacing allows for cleaning behind rack.
- PVC-coated steel wire construction is not affected by bleaches and most acids and solvents.
- Mounts on wall (mounting hardware not included).
- Available in 5-, 12- and 16-hook sizes.



Shown: 5-hook rack. Brushes sold separately.



A. 5-Hook Rack

17-1/4 x 3 x 3 Inches

ITEM NO.	COLOR
3446 40321	Red
3446 40311	Yellow
3446 40301	White
3446 40331	Green
3446 40341	Blue

EACH
\$67.31

B. 12-Hook Rack

26 x 4 x 6-1/2 Inches

ITEM NO.	COLOR
3446 40421	Red
3446 40411	Yellow
3446 40401	White
3446 40431	Green
3446 40441	Blue

EACH
\$97.54

C. 16-Hook Rack

36 x 4 x 6-1/2 Inches

ITEM NO.	COLOR
3446 40511	Yellow
3446 40501	White
3446 40531	Green
3446 40541	Blue

EACH
\$120.88

Closet Organizer and Tool Holder

- S-hooks hold 5/8 inch to 1-1/4 inch handle diameters.
- Double hooks provide easy accessibility.
- Weight: 10.3 pounds.

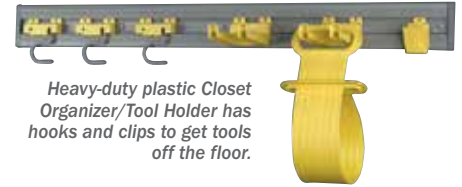

Heavy-duty plastic Closet Organizer/Tool Holder has hooks and clips to get tools off the floor.



ITEM NO.	DIMENSIONS	EACH
1770 03171	34" x 3.24" x 4-1/4"	\$87.65

Vikan® Hygienic Hi-Flex Wall Bracket System

Store cleaning tools and utensils more flexibly and safely.

- Quick and easily installation. • Made from FDA-compliant materials.
- Autoclavable at temperatures up to 250 °F/121 °C

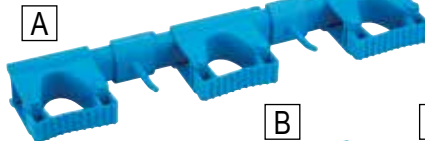
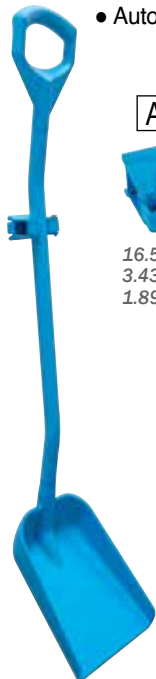
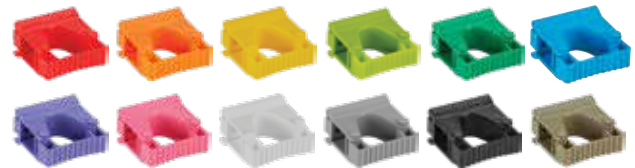

16.54 Inches L x 3.43 Inches D x 1.89 H Inches

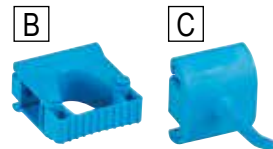

3.23 Inches L x 3.43 Inches D x 1.89 Inches H



Helps keep supplies off the floor. Brushes and other supplies are sold separately.



A. Bracket System

16-1/2-inch bracket includes 3 grip bands and two hooks.

ITEM NO.	COLOR
5281 05461	Red
5281 05491	Orange
5281 05481	Yellow
5281 05531	Lime
5281 05441	Green
5281 05451	Blue
5281 05501	Purple
5281 05431	Pink
5281 05471	White
5281 05541	Gray
5281 05511	Black
5281 05521	Brown

EACH
\$48.08

B. Grip Bands

3.23 inches W x 1.89 inches H x 3.43 inches D.

ITEM NO.	COLOR
5281 05581	Red
5281 05621	Orange
5281 05601	Yellow
5281 05631	Lime
5281 05561	Green
5281 05571	Blue
5281 05641	Purple
5281 05551	Pink
5281 05591	White
5281 05651	Gray
5281 05661	Black
5281 05611	Brown

EACH
\$23.68

C. Single Hook

1.61 inches W x 1.89 inches H x 3.07 inches D.

ITEM NO.	COLOR
5281 05701	Red
5281 05741	Orange
5281 05721	Yellow
5281 05751	Lime
5281 05681	Green
5281 05691	Blue
5281 05761	Purple
5281 05671	Pink
5281 05711	White
5281 05771	Gray
5281 05781	Black
5281 05731	Brown

EACH
\$13.00

Stainless Steel Scraper



- Heavy-gauge stainless steel blade resists rust; provides aggressive scraping action for concrete, tile and resilient floors
- “V” shaped blade construction maintains the optimal scraping angle and also collects debris.
- Do not use as a “chipping” tool – designed for scraping only.
- Blade: 8 inches x 2-3/4 inches.

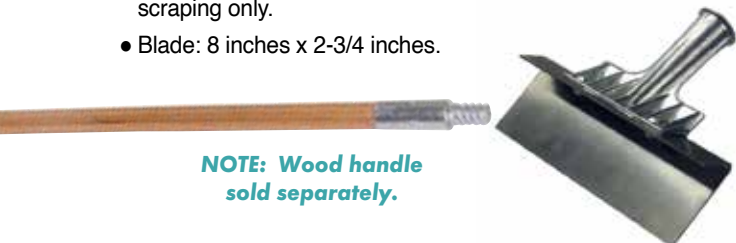

NOTE: Wood handle sold separately.

Stainless Steel Floor Scraper

▶ 12 PER CASE.

ITEM NO.	PRODUCT	EACH
6387 19021	Floor Scraper.....	\$54.03

60-Inch Wood Handle

▶ 12 PER CASE.

ITEM NO.	PRODUCT	EACH
6387 01481	60" Wood Handle, Metal Threads.....	\$4.35

Remco Nylon Floor Scrapers



- Heavy-duty nylon blade.
- Won't damage floors or machines.
- Made from FDA-compliant materials.
- Available in 6 colors.
- Dimensions: 7 inches H x 10-1/5 inches W.



▶ SEE PAGE 111
For Vikan® Handles



NOTE: Must be used with Vikan® color-coded handles. Sold separately. SEE BELOW.



ITEM NO.	COLOR
5281 00201	Black
5281 91151	White
5281 91131	Blue
5281 91121	Green
5281 91161	Yellow
5281 91141	Red

EACH
\$34.05

Vikan® Stainless Steel Floor Scrapers

- 10-1/5-inch wide stainless steel blade.
- For removing stubborn substances.
- Made from FDA-compliant materials.



ITEM NO.	COLOR	EACH
5281 29101	White	\$34.05
5281 29061	Yellow	
5281 29071	Red	
5281 29081	Blue	
5281 29091	Green	
5281 91101	Black	



NOTE: Must be used with Vikan® color-coded handles. Sold separately. SEE BELOW.

Vikan® Ultra Hygiene Poly Handles

- Made of food-grade polypropylene a safe alternative to fiberglass.
- Easy to clean rounded grip handles.
- Hygienic smooth surface, sealed to prevent bacterial growth.
- Larger diameter ergonomic handle shape reduces worker fatigue.



For More Vikan® Handles
▶ SEE PAGE 111



Euro thread.

Hygienic design with smooth surface, sealed to prevent bacterial growth.



GREEN	BLUE	RED	WHITE	YELLOW	ORANGE	BLACK	PURPLE	PINK	BROWN	LIME	GRAY	▶ 10 PER CASE.	
ITEM NO.	ITEM NO.	ITEM NO.	ITEM NO.	ITEM NO.	ITEM NO.	ITEM NO.	ITEM NO.	ITEM NO.	ITEM NO.	ITEM NO.	ITEM NO.	PRODUCT	EACH
5281 86021	5281 86031	5281 16041	5281 86051	5281 96061	5281 86071	5281 96091	5281 96081	5281 96011	---	---	---	51 Inch. . .	\$30.70
5281 86221	5281 16231	5281 16241	5281 96301	5281 96321	5281 86271	5281 96311	5281 86281	5281 96211	H710 00991	5281 03351	5281 04291	59 Inch. . .	30.70

A HANDLE FOR EVERY APPLICATION

Which Handle Should I Order?

Tapered handles fit most squeegees. Threaded handles fit scrub brushes, push brooms and some squeegees. The handles we list with these products on the following pages, are only our recommendation.



NEED HELP? Call one of our Customer Service Representatives for additional information, or to find out about other types of handles not shown.

Tapered Handles

▶ 12 PER CASE.

ITEM NO.	PRODUCT	EACH
6387 02631	A. 54" Tapered Wood Handle	\$7.42
6387 06411	60" Tapered Wood Handle	6.24
6387 41231	B. 60" Tapered Plastic Handle	25.99

Threaded Handles

ITEM NO.	PRODUCT	EACH
1770 00521	C. 60" Lacquered Wood Handle	\$6.55
6387 40281	D. 60" Wood Handle, Nylon Threads.	9.40
6387 65001	E. 54" Plastic Handle	24.83
6387 20571	F. 48" Fiberglass Handle	18.74
6387 99001	G. 60" Stainless Steel Handle	103.37
6387 06441	H. 60" Black, Plastic-Coated Metal Handle	8.03
6387 01481	I. 60" Wood Handle, Metal Threads.	4.35
6387 21631	J. 60" Fiberglass Handle	20.82

Combo Tapered and Threaded Handle

ITEM NO.	PRODUCT	EACH
6387 20111	K. 60" Fiberglass Handle.	\$23.03

Sparta® 3/4-Inch ACME Threaded Fiberglass Handles

- Polyester veil prevents fiberglass surface from splintering.
- Withstands forces up to 250 pounds.
- Hanging cap keeps the handle off the ground and organized.
- Designed for use with Sparta push brooms, sweeps, squeegees and floor scrubs.



48 Inch

ITEM NO.	COLOR
6387 20561	Red
6387 20611	Orange
6387 20581	Yellow
6387 20601	Lime
6387 20551	Green
6387 20531	Blue
6387 20631	Purple
6387 20621	Pink
6387 20641	Tan
6387 20571	White
6387 20591	Gray
6387 20521	Black
6387 20541	Brown

60 Inch

ITEM NO.	COLOR
6387 21621	Red
6387 21671	Orange
6387 21641	Yellow
6387 21661	Lime
6387 21611	Green
6387 21591	Blue
6387 21691	Purple
6387 21681	Pink
6387 21701	Tan
6387 21631	White
6387 21651	Gray
6387 21581	Black
6387 21601	Brown

▶ 12 PER CASE.

EACH
\$18.74

▶ 12 PER CASE.

EACH
\$20.82

Telescoping Poles

- Extendable from 6 to 20 feet. • Threaded.

ITEM NO.	PRODUCT	EACH
6387 26151	A. 8' Aluminum Extension Pole	\$32.47
6387 20001	B. 8' Fiberglass Extension Pole.	45.52
6387 18811	C. 20' Aluminum Extension Poles	105.06
6387 18851	30' Aluminum Extension Poles	162.47



Vikan® Aluminum Handles

- Color-coded ergonomic sleeves are designed to complement Vikan® squeegees.
- Rounded grooves improve grip and reduce muscle fatigue.
- Made from FDA-compliant materials. • European threaded handles.



51 Inch

ITEM NO.	COLOR
5281 93551	White
5281 93561	Yellow
5281 93571	Orange
5281 93541	Red
5281 04571	Pink
5281 93581	Purple
5281 0019	Blue
5281 04581	Lime
5281 93521	Green
H710 00841	Gray
5281 93591	Black

► 10 PER CASE.

EACH
\$28.55

59 Inch

ITEM NO.	COLOR
5281 93751	White
5281 93761	Yellow
5281 93771	Orange
5281 29381	Red
5281 04591	Pink
5281 93781	Purple
5281 93731	Blue
5281 04611	Lime
5281 29391	Green
H710 00991	Brown
5281 93791	Black

► 10 PER CASE.

EACH
\$28.55



VIKAN® HANDLES

Vikan® Telescopic Aluminum Handles

- Adjustable 64 to 115 inches. • European threaded handles.



ITEM NO.	COLOR
5281 97551	White
5281 97521	Green
5281 97531	Blue
5281 97541	Red
5281 97561	Yellow
5281 9759	Black

EACH
\$57.15

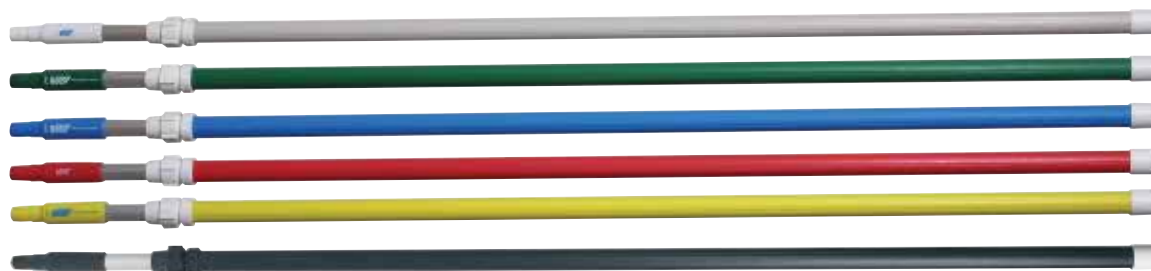

Vikan® Ultra Hygiene Poly Handles

- Made of food-grade polypropylene a safe alternative to fiberglass.
- Easy to clean rounded grip handles.
- Hygienic smooth surface, sealed to prevent bacterial growth.
- Larger diameter ergonomic handle shape reduces worker fatigue.



Euro thread.
Hygienic design with smooth surface, sealed to prevent bacterial growth.



GREEN	BLUE	RED	WHITE	YELLOW	ORANGE	BLACK	PURPLE	PINK	BROWN	LIME	GRAY	PRODUCT	EACH
5281 86021	5281 86031	5281 16041	5281 86051	5281 96061	5281 86071	5281 96091	5281 96081	5281 96011	---	---	---	51 Inch. . .	\$30.70
5281 86221	5281 16231	5281 16241	5281 96301	5281 96321	5281 86271	5281 96311	5281 86281	5281 96211	H710 00991	5281 03351	5281 04291	59 Inch. . .	30.70
5281 01101	5281 96431	5281 01111	5281 01121	5281 01171	---	---	---	---	---	---	---	67 Inch. . .	39.16

► 10 PER CASE.

Remco Lobby Dust Pan and Broom

Made especially for food processing facilities — no hard angles that could trap food residue or bacteria and can be easily disassembled and reassembled for regular washing and sanitizing.

- The 37-inch handle prevents back pain that stems from leaning over shorter dustpans.
- Large, 7-inch x 14-inch bin allows for big and small cleanup jobs.
- High-tension hinge lock holds pan open for easy usage and is activated by pushing the dustpan handle back until the lock clicks into place.
- Hanging holes allow the tools to be hung from any hook-based storage rack.
- Grips provide enhanced handling. • FDA-compliant materials.

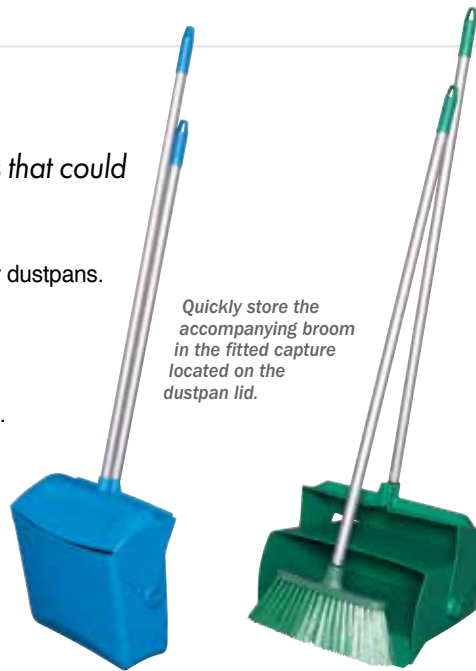

Quickly store the accompanying broom in the fitted capture located on the dustpan lid.

Remco
a Vikon company



ITEM NO.	COLOR
5281 03131	White
5281 02551	Yellow
5281 02521	Orange
5281 03141	Red
5281 03161	Pink
5281 02531	Purple
5281 03151	Blue
5281 02561	Green
5281 03121	Black

EACH
\$99.59

A. Dust Pan Broom

- Flagged polypropylene bristles.
- 28-inch vinyl coated handle with 7-7/8-inch broom head.

▶ 6 PER CASE.

ITEM NO.	PRODUCT	EACH
1770 78631	Dust Pan Broom	\$13.95

B. Dust Pan with Handle

For fast, effective spot cleaning without bending.

- Dimensions: 12-3/4 inches x 11-1/4 inches x 5 inches.
- Color: black. • 31-inch handle.

▶ 12 PER CASE.

ITEM NO.	PRODUCT	EACH
1770 41491	Dust Pan	\$38.45



Duo-Pan™ Lobby Broom and Dust Pan

- Pivoting bucket locks open for hands-free disposal.
- Broom has two handle holes — one angled, one upright — and has black stiff filament for heavier sweeping.
- Clip attaches the broom handle to the dustpan handle.
- Dustpan and broom both have a 30-inch metal handle.
- Dustpan is 12 inches wide.



ITEM NO.	PRODUCT	EACH
6387 77611	Duo-Pan™ Lobby Broom/Dust Pan	\$32.29
6387 25771	Replacement Lobby Broom	12.56
6387 06291	Replacement Dust Pan	21.16

Heavy-Duty Stand Up Debris Pan

- Locking latch for secure lifting and emptying of heavy loads up to 25 pounds.
- Extra large opening is wide enough to fit an 18-inch push broom.
- Large storage capacity reduces trips to empty the pan.

▶ 6 PER CASE.

ITEM NO.	PRODUCT	EACH
1770 23301	Dust Pan	\$47.15



Heavy-Duty Jumbo Dust Pan

Extra large size to accommodate large jobs.

- 22 inches L x 18 inches W x 7-3/4 inches D.
- Color: black.

▶ 6 PER CASE.

ITEM NO.	PRODUCT	EACH
1770 60001	Jumbo Dust Pan	\$21.35



Dust Pan

- Color: charcoal. • 12-1/4 inches L x 8-1/4 inches W x 2-5/8 inches D.

▶ 12 PER CASE.

ITEM NO.	PRODUCT	EACH
1770 20051	Dust Pan	\$11.75

Vikan® Color-Coded Dust Pans

- Rigid, one-piece, injection-molded polypropylene FDA-compliant construction.
- Will not rust or corrode.

NOTE: Also available in orange, pink, purple, lime, brown and gray.



ITEM NO.	COLOR	
5281 66051	White	
5281 66061	Yellow	
5281 66041	Red	
5281 66031	Blue	▶ 10 PER CASE.
5281 66021	Green	EACH
5281 66101	Black	\$17.97



Vikan® Angled Dust Pan Brooms

Angled design to reach into narrow spaces.

- Light-weight broom for both dry and wet debris.
- Polypropylene block with medium stiffness bristles.
- Built-in scraping edge. • Length: 9.8 inches.

ITEM NO. COLOR

5281 06521	White
5281 06531	Yellow
5281 06511	Red
5281 06501	Blue
5281 06491	Green
5281 06541	Black

▶ 10 PER CASE.

EACH

\$19.72



Vikan® Split Bristle Angle Head Brooms

Designed to handle fine particles like dust, flour and powdered sugar.

- Broom head is made of FDA-compliant materials.
- 1-3/4 inches W x 11-1/2 inches L x 9-1/4 inches H.

ITEM NO. COLOR

H710 00691	White
H710 00681	Yellow
5281 06581	Orange
H710 00701	Red
5281 06591	Purple
H710 00711	Blue
H710 00721	Green
5281 06601	Brown
5281 06611	Gray
H710 00671	Black

▶ 10 PER CASE.

EACH

\$31.75



▶ SEE PAGE 111

Vikan® Handles Sold Separately.

Vikan® Extra-Stiff Angle Cut Brooms

Designed to reach narrow spaces.

- It is particularly effective for collecting large particles of debris like meat and vegetables in a moist environment.
- Polypropylene block material with polyester bristles.
- Length: 12 inches.

ITEM NO. COLOR

5281 91451	White
5281 91461	Yellow
5281 01261	Orange
5281 91441	Red
5281 06551	Purple
5281 91431	Blue
5281 91421	Green
5281 06561	Brown
5281 06571	Gray
5281 00351	Black

▶ 10 PER CASE.

EACH

\$29.63



▶ SEE PAGE 111

Vikan® Handles Sold Separately.

Molded Plastic Brooms

- Two different angled holes for the handle.
- Heavy-duty one-piece molded block construction.
- The 48-inch handle comes with a reinforced standard threaded tip and hanging hole.

▶ 12 PER CASE.

ITEM NO.	PRODUCT	EACH
6387 25801	A. Black, Stiff Bristle	\$20.93
6387 25781	B. Blue, Flagged Bristle	20.93



Jumbo Smooth Sweep Angle Broom

Ideal for cleaning hard to reach areas.

- Cut and shaped for easy sweeping.
- Polypropylene fill bristles.
- Permanent fusion-set bristles won't pull out.
- Black metal handle is 1 inch in diameter.

▶ 6 PER CASE.

ITEM NO.	PRODUCT	EACH
1770 63901	Angle Broom	\$19.35



Sparta® Duo-Sweep® Angle Brooms

Flagged polypropylene bristles catch fine dust and debris for a deeper clean.

- Durable fiberglass handle offers a stable grip and extended reach to cover more ground quicker.
- Save space by hanging broom on walls behind doors or in closets.
- Remove and replace handle as needed.
- 56 inches L x 12 inches W.



ITEM NO.	COLOR	ITEM NO.	COLOR
6387 22601	Red	6387 22581	Pink
6387 22571	Orange	6387 22611	Tan
6387 22631	Yellow	6387 22621	White
6387 22561	Lime	6387 22541	Gray
6387 22551	Green	6387 22511	Black
6387 22521	Blue	6387 22531	Brown
6387 22591	Purple		

▶ 12 PER CASE.

EACH
\$34.81



Corn Broom

100% natural corn fibers

- Removes fine dirt from even or rough surfaces.
- For rugged indoor and outdoor cleaning.
- Heavy-duty lacquered pine handle is 1-1/8 inches in diameter.
- Length: 56 inches.



▶ 12 PER CASE.

ITEM NO.	PRODUCT	EACH
1770 63831	Corn Broom	\$24.05

Hardwood Push Broom



- Soft, lightly crimped and flagged 3-inch polypropylene bristles ideal for sweeping dust and fine particles on smooth surfaces.
- Sturdy synthetic bristles provide moisture and chemical-resistance.
- 24-inch hardwood block with two threaded handle holes.



▶ 12 PER CASE.

ITEM NO.	PRODUCT	EACH
6387 06851	Flagged Bristle Head	\$22.05

Sparta® Color-Coded Omni Sweeps®

- Combines heavy front bristles with fine and medium back bristles for a more thorough clean.
- Non-absorbent block provides a more hygienic use.
- Use with sweeping compounds for an even deeper clean.
- FDA-compliant.



▶ SEE PAGE 110

We Recommend Sparta® Fiberglass Handles.
Sold Separately.

18 Inch

ITEM NO.	COLOR
6387 19571	Red
6387 19521	Orange
6387 19611	Yellow
6387 19501	Lime
6387 19491	Green
6387 19431	Blue
6387 19551	Purple
6387 19531	Pink
6387 19581	Tan
6387 19591	White
6387 19481	Gray
6387 19421	Black
6387 19441	Brown

▶ 12 PER CASE.

EACH
\$20.82

24 Inch

ITEM NO.	COLOR
6387 20471	Red
6387 20441	Orange
6387 20511	Yellow
6387 20431	Lime
6387 20421	Green
6387 20351	Blue
6387 20461	Purple
6387 20451	Pink
6387 20491	Tan
6387 20501	White
6387 20411	Gray
6387 20341	Black
6387 20391	Brown

▶ 12 PER CASE.

EACH
\$29.66



Vikan® 24-Inch Push Brooms

Perfect for HACCP color-coding.

- FDA-compliant polypropylene block material with polyester bristles.
- Soft/Stiff Broom contains two types of bristles to first help loosen stubborn dirt and move heavy debris and then gather the finer particles.

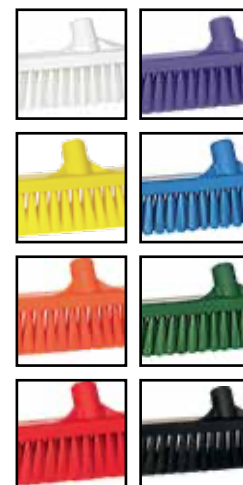

Soft

ITEM NO.	COLOR
5281 19951	White
5281 19961	Yellow
5281 19971	Orange
5281 19941	Red
5281 19981	Purple
5281 19931	Blue
5281 19921	Green
5281 19991	Black

Soft/Stiff

ITEM NO.	COLOR
5281 19451	White
5281 19461	Yellow
5281 19441	Red
5281 19431	Blue
5281 19421	Green
5281 00371	Black

▶ SEE PAGE 111
Handles Sold Separately.

▶ 6 PER CASE.
EACH
\$49.76

Vikan® Ultra Safe Technology (UST) Brooms

- The innovative technology utilizes enhanced bristle security units directly molded to the brush block, removing any gaps or seams while offering unprecedented bristle retention strength.
- Soft broom contains bristles that are great for sweeping fine particles in dry areas.
- One-piece design, no metal staples or resin. • Easy to clean and dry.
- Easy color-coded visual inspection. • Width: 16 inch.
- Made with FDA-compliant materials.



▶ SEE PAGE 111
Use With Vikan®
Color-Coded Handles.
Sold Separately.



Soft

ITEM NO.	COLOR
5281 00711	White
5281 00721	Yellow
5281 00731	Orange
5281 00701	Red
5281 00671	Pink
5281 00761	Purple
5281 00691	Blue
5281 00681	Green

▶ 6 PER CASE.
EACH
\$46.59

Medium

ITEM NO.	COLOR
5281 00811	White
5281 00821	Yellow
5281 00831	Orange
5281 00801	Red
5281 00771	Pink
5281 00841	Purple
5281 00791	Blue
5281 00781	Green

▶ 6 PER CASE.
EACH
\$46.59

THE INNOVATIVE ULTRA SAFE TECHNOLOGY (UST)

Utilizes enhanced bristle security units directly molded to the brush block, removing any gaps or seams while offering unprecedented bristle retention strength.

Plastic Push Brooms

- Two threaded handle holes.
- Sanitary, water/rot-resistant 24-inch plastic block.
- Durable 3-inch polypropylene bristles, embedded in a structural foam block, resist acids and fungus.

Handles Sold Separately. ▶ SEE PAGE 110

▶ 12 PER CASE.

ITEM NO.	PRODUCT	EACH
6387 06481	Fine/Medium Head	\$24.20
6387 07181	Coarse Head	24.31
6387 45281	Brace Assembly	8.59



Optional
Brace Assembly.



PUSH BROOMS AND SWEEPS

Microfiber™ Cleaning System

Microfiber material dries faster and more thoroughly than common rags and rag mops — reducing the potential for encouraging bacterial, mold and mildew growth.



A. Wet Mop Pad

- Greater surface contact eliminates the need to mop the same area over and over.
- Special looped-end fibers glide over floors for easier mopping, no linting.
- Available in two sizes: 18 inch or 24 inch.

B. Dry Mop Pad

- Ribbed center mat attracts and holds dust like a magnet.
- Large looped fringe keeps dust from flying; grabs larger particles and debris.
- Unique design polishes hardwood, marble, terrazzo and other smooth surfaces as you dust.
- Available in two sizes: 18 inch or 24 inch.

C. Aluminum Heads

- For use with wet or dry microfiber floor pads.
- Heavy-duty aluminum construction.
- Triple riveted VELCRO® for durability.

D. Telescoping Aluminum Handle

- Designed for use with aluminum mop head shown above.
- Handle extends from 40 to 70 inches.



▶ 12 PER CASE.

ITEM NO.	PRODUCT	EACH
6387 37101	A. Wet Mop Pad, 18"	\$8.14
6387 37151	Wet Mop Pad, 24"	10.56
6387 37201	B. Dry Mop Pad, 18"	8.02
6387 37211	Dry Mop Pad, 24"	10.47
6387 35191	C. Aluminum Head, 18"	17.59
6387 25021	Aluminum Head, 24"	22.50
6387 15791	D. Telescoping Handle, 70"	15.58

6-Gallon Mop Pail with Lid

- Ideal for carrying soiled pads and cloths.
- Rectangular shape.
- Color: gray.

Rugged poly carrying handle.



Ideal for use with 18-inch wet mop pads.



Includes lid.

▶ 12 PER CASE.

ITEM NO.	DIMENSIONS	EACH
6387 19231	20-1/2" x 10-1/2" x 11-1/4"	\$51.61

Dust Mop System

A. Snap-On Wire Dust Mop Frame

- Mop frame is corrosion-resistant, powder-coated, heavy-duty metal for durable performance.

B. Snap-On Wire Dust Mop Handle

- Fiberglass handle swivels a full 360°.

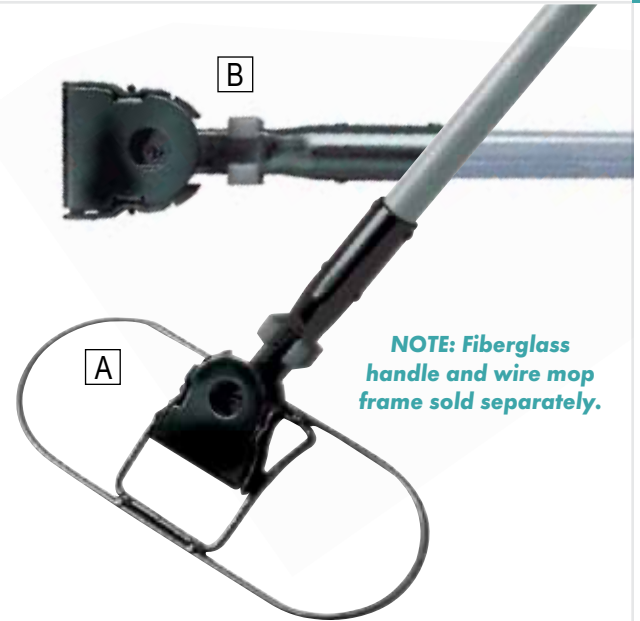

NOTE: Fiberglass handle and wire mop frame sold separately.

► 12 PER CASE.

ITEM NO.	PRODUCT	SIZE	EACH
1770 24301	A. Mop Frame	.24" x 5"	\$16.35
1770 12551	Mop Frame	.36" x 5"	18.55
1770 02571	Mop Frame	.48" x 5"	24.05
1770 04451	B. Fiberglass Handle	.60"	32.45

Pro-Color Dust Mops

- Made with blended cotton/polyester yarn and sewn to a resistant polyester canvas resulting in high resistance to abrasion, long durability and low absorption.
- Ideal for mopping under equipment and behind furniture.
- Color-coded for easy compliance.



NOTE: Fits wire frame above. Sold separately.

36-Inch Dust Mop

36-1/4 Inches x 6-3/4 Inches x 1 Inch

ITEM NO.	COLOR	EACH
7538 01091	Yellow	► 12 PER CASE. \$21.28
7538 01111	Blue	
7538 01121	Black	
7538 01131	White	

Super Disposable Rags

- Ideal alternative to cloth rags and shop towels.
- Strong, durable and absorbent rags are virtually lint-free and reusable.
- 12 inch x 17 inch rags are 1/4 folded and come in a convenient dispenser box.



► 250 WIPES PER BOX.

ITEM NO.	PRODUCT	BOX
4702 0792	Disp. Multi-Purpose Rags	\$93.60

Polishing/Cleaning Cloths

- Keeps surfaces gleaming without sprays and chemicals.
- Super-tough terry cleaning cloths work better and last longer than cotton rags.
- Microfiber loops hold dirt and grease — won't redeposit.
- Rinse clean and dry fast.
- Color: blue.



► 12 PER CASE.

ITEM NO.	SIZE	EACH
6387 37261	16" x 16"	\$3.42

Launderable Dust Mop

- Pre-laundered; synthetic backing and looped-end construction for less lint and effective dust mopping.
- Blue synthetic backing, with key hole and ties withstands repeated laundering.
- Sewn construction for longer life.



NOTE: Fits wire frame above. Sold separately.



► 12 PER CASE.

ITEM NO.	SIZE	EACH
6387 09191	24" x 5"	\$30.92

HOW TO CHOOSE THE RIGHT MOP

Choose a mop handle.



QUICK SLIDE STYLE



GRIP/CLAMP STYLE



NARROW BAND



WIDE BAND

Replacement Handle?

► SEE PAGE 110
For Ordering Information

QUESTIONS? Call us 800-456-5624



TAPERED

THREADED

COMBO

Jaw Style Fiberglass Mop Handle

- Designed to be used with wide-band mesh headbands.
- "Bites" into mop for a secure hold and precision handling.
- Handle length: 60 inches.

ITEM NO.	COLOR
6387 23741	Red
6387 23761	Orange
6387 23541	Yellow
6387 23561	Green
6387 23751	Blue
6387 23771	Purple
6387 23721	White
6387 23731	Black

► 12 PER CASE.
EACH
\$23.05



Invader® Wet Mop Handle

Hinged side-gate allows mop to easily slide on and off handle.

- Large plastic mop heads contain antimicrobial product protection which inhibits the growth of bacteria that cause odors and stains.
- Thumb wheel on handle clamps the mop firmly in place.
- 60-inch fiberglass handle.
- Uses only 1 inch headband mops.



Easy to use hinged side gate.

► 12 PER CASE.

ITEM NO.	PRODUCT	EACH
1770 14601	Invader® Wet Mop Handle.....	\$33.55

Sparta® Color-Coded Quik-Release™ Mop Handle

- Flexible plastic head with hinged gripper bites into any size mop band and secures it for maximum performance.
- Handle length: 60 inches.

ITEM NO.	COLOR
6387 64051	Red
6387 64041	Yellow
6387 64091	Green
6387 64141	Blue
6387 64021	White

► 12 PER CASE.

EACH
\$23.47



Gripper® Wet Mop Handle

Holds mop firmly between the jaws of the mop handle.

- Plastic mop heads contain antimicrobial product protection which inhibits the growth of bacteria that cause odors and stains.
- 60-inch fiberglass handle.
- Uses only 5 inch headband mops.



Jaws open to allow easy installation.

► 12 PER CASE.

ITEM NO.	PRODUCT	EACH
1770 06051	Gripper® Wet Mop Handle.....	\$41.15

NOTE: Mop heads sold separately.
SEE FACING PAGE.

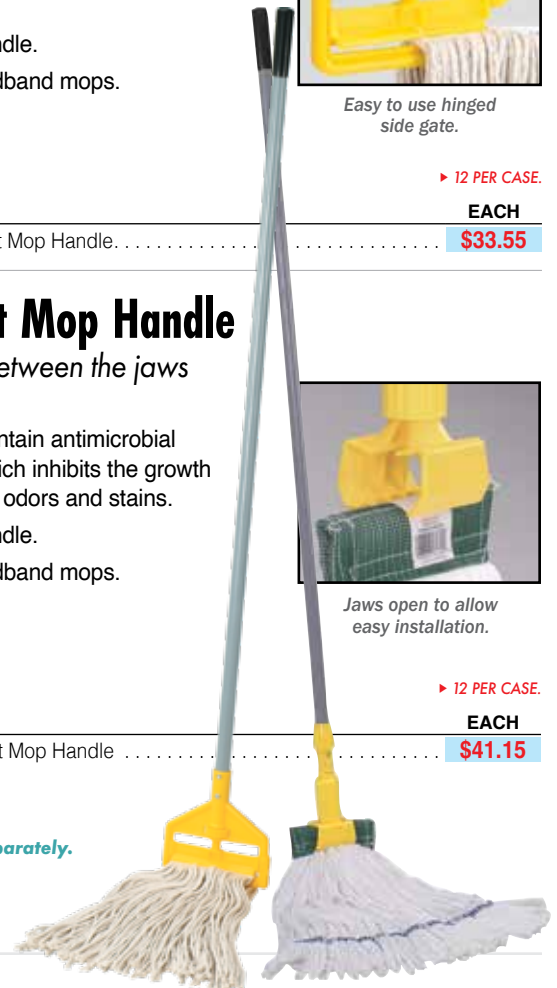

For QUICK SLIDE Style Handles

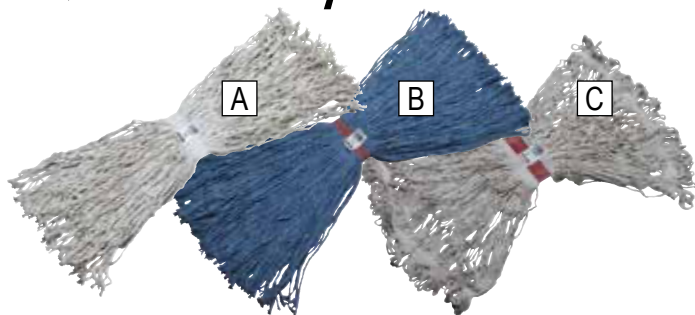

A. Value-Pro™ Cotton Mop

- Economical cotton mop for all-purpose cleaning.
- 20 ounces with 1-inch white headband. • White strands with cut ends.

B. Dura-Pro® Blend Mop

- 24 ounces with 1-inch orange headband. • Blue strands with cut ends.
- 4-ply cotton/rayon/synthetic yarn blend for good performance and reliability.

C. Super Stitch® Blend Mop

Outperforms and outlasts premium cut-end mops two to one.

- 24 ounces with 1-inch red headband. • White strands with looped ends.
- Balanced blend of cotton and synthetic yarns for absorbency and strength.

▶ 12 PER CASE.

ITEM NO.	PRODUCT	EACH
1770 11171	A. Value-Pro™ Cotton Mop	\$8.65
1770 65181	B. Dura-Pro™ Blend Mop	12.95
1770 21301	C. Super Stitch® Blend Mop	16.35

4-Ply Cut-End Mop Heads



- Synthetic rayon fiber mop head is mildew resistant, has good tensile strength and is quick drying.
- Natural cotton fiber mop head has higher absorbency for heavier cleaning applications and requires less “break in” time.

For QUICK SLIDE Style Handles

A. Synthetic Rayon

ITEM NO.	PRODUCT	DOZEN
6387 1443	Narrow Band, #16	\$62.39
6387 1439	Narrow Band, #24	94.67

B. Natural Cotton

ITEM NO.	PRODUCT	DOZEN
6387 4803	Narrow Band, #16	\$48.34

ITEM NO.	PRODUCT	EACH
6387 16301	Narrow Band, #24	\$6.98



For GRIP/CLAMP Style Handles

C. Natural Cotton

ITEM NO.	PRODUCT	DOZEN
6387 1441	Wide Band, #16	\$49.37
6387 0999	Wide Band, #24	74.92
6387 1442	Wide Band, #32	96.14

Wide Band (shown unfolded)

For QUICK SLIDE or GRIP/CLAMP Style Handles

20-Ounce Color-Coded Looped-End Mops

- Durable double-sewn 5-inch band prevents tangles and provides more floor coverage with each stroke.
- Made from a variety of high-quality fiber materials for better absorbency and long lasting use.
- Looped-end design lints less, reduces fraying and raveling. • Color-coded for easy compliance.
- Washable and fast drying.



ITEM NO.	COLOR	▶ 12 PER CASE. EACH
7538 01141	Red	\$18.67
7538 01161	Green	

GRIP Style, Lint-Free Jersey Mop Head

Cotton/poly jersey mop head will not leave lint behind.

- 5-inch headband. • 20-ounce jersey material.
- Looped ends.

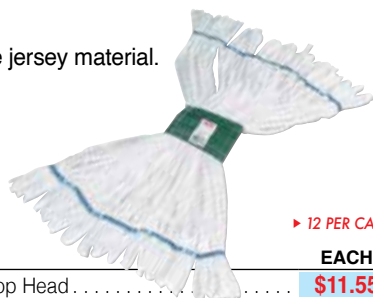

▶ 12 PER CASE.

ITEM NO.	PRODUCT	EACH
1770 22551	Jersey Wide Band Mop Head	\$11.55

QUICK SLIDE Style, Lint-Free White “T-Shirt” Mop Head



Made from NEW white t-shirt material.

- Recommended for rough surfaces and provides quicker drying times.



ITEM NO.	PRODUCT	EACH
6387 12181	White “T-Shirt” Mop Head, Narrow Band	\$12.54

Safety Cone Cordless Floor Dryer

Decrease your floor drying time by up to 90% and reduce the opportunity for slip and fall accidents.

- Cordless and rechargeable. • Runs up to 8 hours on a replaceable battery pack.
- Aids in drying the floor with a continuous flow of air in 360° around unit and up to 15 foot diameter.
- Offers the additional advantage of warning while drying.
- LED and audible warnings of low battery voltage.
- Corrosion, chemical and impact resistant.
- 36-inch cone included.

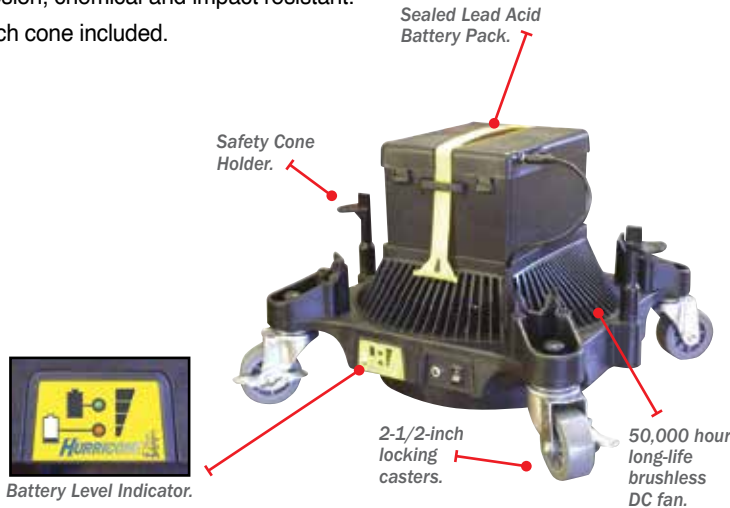

Scan this QR code with your mobile device to watch a video about the Hurricane Cordless Floor Dryer.



Aids in drying the floor with a continuous flow of air diameter.



ITEM NO.	PRODUCT	DIMENSIONS	WEIGHT	EACH
E484 6000	36" Safety Cone/Cordless Floor Dryer.	14-3/10" x 14-3/10" x 11"	36 lb.	\$459.25

Caution Signs



A. Wet Floor Sign

- Two-sided sign. • "Caution Wet Floor" message.
- Specially contoured feet minimize contact with floor.

ITEM NO.	DIMENSIONS	EACH
1770 03401	11" x 11" x 25-1/2"	\$22.45

B. Caution Sign

- Message in English, French, German and Spanish.
- Large four-sided message, visible for up to 30 feet.
- Folds flat for storage.

ITEM NO.	DIMENSIONS	EACH
1770 61141	12" x 16" x 37"	\$65.25

Safety Cones

- Stackable, bright yellow safety cones are highly visible from any angle and meet OSHA standards.
- Bilingual "Caution Wet Floor" message.
- Molded-in slots accept plastic barrier chains and make handling easy.
- Available in 25 inch or 36 inch height.
- Dimensions: 12-1/4 inch square base.



▶ 6 PER CASE.

ITEM NO.	PRODUCT	EACH
1770 62751	25" Safety Cone.	\$55.65
1770 62761	36" Safety Cone.	64.35

Pop-Up Safety Cones

- Collapsible deployed cone comes with a wall mountable storage tube.
- Cone automatically opens and folds compactly when not in use.
- Bold yellow color and ANSI approved graphics are instantly recognizable from any angle.
- Relays "Caution" message in three languages.
- Available in 20 inch or 30 inch height.



▶ 12 PER CASE.

ITEM NO.	PRODUCT	EACH
1770 62711	20" Safety Cone.	\$58.05
1770 62701	30" Safety Cone.	70.15

Splash-Reducing Mopping System

WaveBrake™ technology reduces splashing by 40%!

- Quiet caster dolly with non-rusting casters are more quiet than traditional metal casters.
- Includes easy-lift handle and graduated marks for measuring fluid.
- Side-press wringer requires 18% less effort to wring mops.
- Mop clip for secure mop transport.



Scan this QR code with your mobile device to watch a video about this product.

31-Quart Tandem™ Mop Bucket and Wringer

The perfect combination of quality and convenience for mops up to 24 ounces.

- Holes in both wringing plates force more water from mop in less time.
- Reverse-wringing mechanism for more comfortable use.
- Built-in lift handles on bottom of bucket make lifting and emptying easier.
- Dimensions: 22-3/5 L inches x 13-3/10 inches W x 32-3/10 inches H.



ITEM NO.	PRODUCT	EACH
1770 05641	26 qt. Wavebreak Mopping System Combo, Side Press	\$143.45
1770 8188	35 qt. Wavebreak Mopping System combo, Side Press	189.45

ITEM NO.	PRODUCT	EACH
1770 7380	Mop Bucket and Wringer	\$107.05

OmniFit™ 35-Quart Down Press Mop Bucket Combo

- Sturdy corrosion-resistant polyethylene construction.
- Down-press wringers prevent splashing and spilling.
- 17 inches L x 23 inches W x 35 inches H.
- Non-marking casters.

SPARTA®



ITEM NO.	COLOR	EACH
6387 2413	Yellow	\$183.94

OmniFit™ 35-Quart Side Press Mop Bucket Combo

- Sturdy construction made from corrosion-resistant polyethylene.
- Side-press wringers prevent splashing and spilling.
- 21 inches L x 18 inches W x 36 inches H. • Non-marking casters.



Shown with optional Soiled Water Insert Bucket, sold separately.

ITEM NO.	COLOR	EACH
6387 2395	Red	
6387 2394	Yellow	
6387 2397	Green	
6387 2398	Blue	
6387 2396	Brown	\$174.21
6387 2418	Black	

SPARTA®



ITEM NO.	COLOR	EACH
6387 2437	Soiled Water Bucket	\$39.80

Roller Mop

- Use to clean condensation from walls and ceilings.
- Lever action wrings moisture from sponge.
- 12-inch highly absorbent sponge.
- Choose between 51-inch standard mop and handle or an extra-long 8-foot reach extension handle.



Mop with 8' extension handle available.



▶ 6 PER CASE.

ITEM NO.	PRODUCT	EACH
6387 06161	w/51" Handle	\$30.92
6387 2628	w/8' Handle	105.58
6387 06171	Replacement Sponge	13.28

Steel Sponge Mop

- Cellulose sponge mop head absorbs liquids fast.
- 12-inch synthetic sponge.
- Replacement cellulose heads available.

Front pull lever on mop handle for squeeze-action wringing.



▶ 6 PER CASE.

ITEM NO.	PRODUCT	EACH
1770 00481	Steel Sponge Mop.	\$73.45

▶ 12 PER CASE.

ITEM NO.	PRODUCT	EACH
1770 64361	Repl. Sponge.	\$25.15

Quickie 674 Roller Mop

- Replaceable scrubbing pad feature.
- Swivel hang up feature for off the floor storage.
- Cellulene sponge mop head.
- Replaceable scrubbing pad feature.

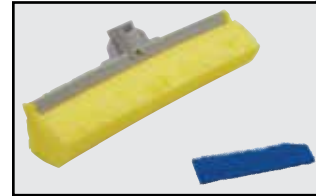

Replaceable sponge head and scrubbing pad.

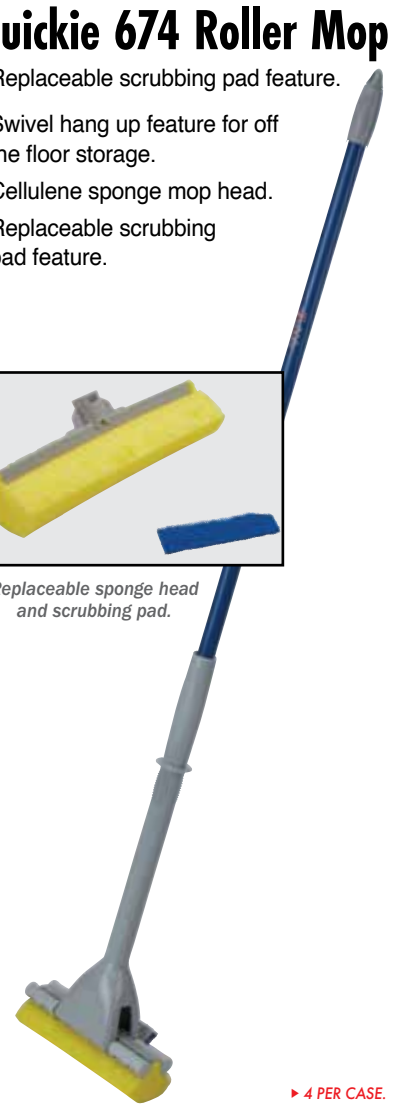

▶ 4 PER CASE.

ITEM NO.	PRODUCT	EACH
5619 00111	Roller Mop	\$22.35

▶ 12 PER CASE.

ITEM NO.	PRODUCT	EACH
5619 00101	Repl. Sponge.	\$9.25

Cellulose Sponge

- Cellulose sponges are made from wood fiber and are biodegradable.

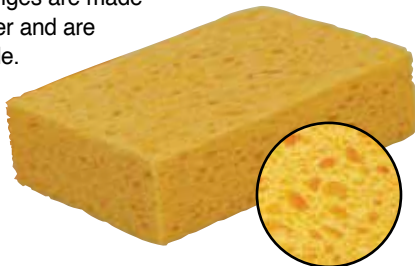

▶ 24 PER CASE.

ITEM NO.	DIMENSIONS	CASE
6710 0130	7" x 5" x 1.625"	\$129.12

Hydra® Aquawash-n-Dri® Sponges

- Excellent abrasive action when washing walls or other surfaces.
- Easy to handle sponge stays soft and pliable.
- Synthetic material will not mildew.
- Color: orange.



▶ 48 PER CASE.

ITEM NO.	DIMENSIONS	CASE
3898 0007	7" x 4-1/4" x 2"	\$55.95



Quality Tools for Smart Cleaning™

Fixi-Clamp and Sponge

Clean high areas without ladders!

- Firmly grips sponges, cloths, mop heads and chamois. Adjust grip by tightening the ribbed locking collar.
- Sturdy, light-weight telescopic poles are constructed of anodized, extruded aluminum — easy-lock mechanism with snap-in locking cone.
- Sponge: 8-1/2 inches x 4 inches x 2-3/4 inches.



18 foot and 30 foot, 3-section extended poles also available.



Pictured here with the 13 foot, 2-section extended pole.

▶ 10 PER CASE.

ITEM NO.	PRODUCT	EACH
7035 10021	Clamp Only	\$45.44

▶ 100 PER CASE.

ITEM NO.	PRODUCT	EACH
7035 10011	Sponge Only	\$7.81

▶ 10 PER CASE.

ITEM NO.	PRODUCT	EACH
7035 00131	13' Ext. Pole	\$78.84
7035 00181	18' Ext. Pole	118.75
7035 0271	30' Ext. Pole	166.63

Telescopic Pole and Scrubber

- Designed for washing windows, cleaning window screens and dusting in high reach areas.
- 6- to 12-foot telescopic pole has a sure-grip surface for greater control when hands are wet.



Sewn in scrubber pad is located on one end.



Scrubber rotates 180° for optimum reach.

NOTE: T-Bar and scrubber cover sold separately.

▶ 6 PER CASE.

ITEM NO.	PRODUCT	EACH
6512 16181	18" T-Bar	\$19.95
6512 00491	12' Telescopic Pole	47.15

▶ 10 PER CASE.

ITEM NO.	PRODUCT	EACH
7035 05721	Scrubber Cover	\$27.66

Vikan® Ceiling Squeegee

- Designed to help you squeegee condensation off of the ceiling.
- Condensation is captured in the rustproof, SEBS and polypropylene squeegee and drains through the hollow, telescopic handle.
- Squeegee measures 16 inches x 3 inches.



Squeegee trough collects water and drains out of handle.

NOTE: 16-foot 2-inch fiberglass telescopic handle sold separately.

ITEM NO.	COLOR	EACH
5281 71191	White	▶ 6 PER CASE. \$49.77
5281 71661	Yellow	
5281 71641	Red	
5281 71631	Blue	
5281 71621	Green	

▶ 6 PER CASE.

ITEM NO.	PRODUCT	EACH
5281 6269	Handle w/Drain	\$72.03

Large Cellulose Sponge

- Perfect for everyday use and maintenance.
- Provides unparalleled absorption.



▶ 100 PER CASE.

ITEM NO.	PRODUCT	EACH
7035 10011	Sponge Only	\$7.81



Quality Tools for Smart Cleaning™

CEILING SCRUBBERS, SQUEEGES AND SPONGES

Sparta® Flo-Thru Brush

- Excellent for cleaning greasy surfaces from kitchen walls and equipment.
- Rounded block to help protect painted surfaces and delicate trim. • Temperature range: -40° to 125 °F.
- Soft Nyllex (flagged) bristles set in non-absorbent plastic blocks that won't crack or chip.
- Bristle trim: 2-1/2 inches. • Brush head: 10 inches long. • FDA-compliant.



ITEM NO.	COLOR
6387 22751	Red
6387 22721	Orange
6387 22781	Yellow
6387 22711	Lime
6387 22701	Green
6387 22661	Blue
6387 22741	Purple
6387 22731	Pink
6387 22761	Tan
6387 22771	White
6387 22691	Gray
6387 22651	Black
6387 22671	Brown



▶ 12 PER CASE.
EACH
\$27.98



Flo-Thru Scrub System



- 10-inch heavy-duty five-hole flow-thru foam block.
- Flared, long lasting crimped polypropylene bristles – great for walls and under equipment.
- Die cast metal valve fits in brass connection and attaches to hose threads for easy control of water flow (order separately.)



ITEM NO.	PRODUCT	EACH
6387 06391	Flow-Thru Dual-Surface Scrub Brush	\$18.95

Carlisle® Flo-Thru Nyllex Brush



- 2-1/2-inch crimped white, soft nyllex bristles.
- 9-1/2-inch brush block has one flow-thru handle hole.



▶ 6 PER CASE.

ITEM NO.	PRODUCT	EACH
6387 22641	Equipment Brush	\$27.98

Hose Accessories

Garden Hose Thread (GHT)

NOTE: These accessories work with all Flow-Thru products on this page.

Brass On/Off Flow Control Valve

3/4 Inch Male GHT x 3/4 Inch Female GHT

ITEM NO.	PRODUCT	EACH
3013 10161	Brass On/Off Valve	\$31.15



For More Hose Adapters ▶ SEE PAGE 151

Brass Swivel Accessory

3/4 Inch Male GHT x 3/4 Inch Female GHT

ITEM NO.	PRODUCT	EACH
3013 00171	Brass Swivel	\$26.55



Stainless Steel Quick Connect Set

3/4 Inch Male GHT x 3/4 Inch Female GHT

ITEM NO.	PRODUCT	EACH
3013 21041	SS Connect Set	\$48.45



Sparta® Swivel Scrub® Floor Brush

- Perfect for everyday use in food preparation and food processing areas.
- Swivels onto its side to clean baseboards, walls, equipment and hard-to-reach areas.
- Polyester scrub resists water, high temperatures, acids, alkalis and most cleaning solutions.
- Brush length: 8 inches. • Bristle trim: 1 inch. • Temperature range: -40° to 125 °F.
- FDA-compliant. • BPA free.

NOTE:
More colors
available.
CALL FOR
DETAILS.



▶ SEE PAGE 110
Handles Sold Separately.



ITEM NO.	COLOR
6387 23351	Yellow
6387 23301	Green
6387 23311	Blue

▶ 12 PER CASE.

EACH
\$26.38

▶ SEE PAGE 110

**FOR FIBERGLASS
CARLISLE HANDLES**

10-Inch Bi-Level Floor Scrub

- Crimped bristles resist absorbing oils and moisture and wash easily. • BPA free. • Standard 3/4-inch ACME thread.
- Split shape cleans flat surfaces, under counters, around equipment and along baseboards. • Foam-injected block provides additional durability.
- Bristle trim: 1-3/4 inches. • Temperature range: -40° to 125 °F. • FDA-compliant.



A. w/o Side Bristles

ITEM NO.	COLOR
6387 19881	Red
6387 19851	Orange
6387 19951	Yellow
6387 19841	Lime
6387 19831	Green
6387 19801	Blue
6387 19871	Purple
6387 19861	Pink
6387 19891	Tan
6387 19941	White
6387 19821	Gray
6387 19791	Black
6387 19811	Brown

▶ 12 PER CASE.

EACH
\$17.89

B. With Side Bristles

ITEM NO.	COLOR
6387 19751	Red
6387 19721	Orange
6387 19781	Yellow
6387 19711	Lime
6387 19701	Green
6387 19511	Blue
6387 19741	Purple
6387 19731	Pink
6387 19761	Tan
6387 19771	White
6387 19561	Gray
6387 19471	Black
6387 19541	Brown

▶ 12 PER CASE.

EACH
\$25.78



Dual-Surface® Scrub System

- Flared, long lasting crimped polypropylene bristles – great for walls and under equipment.
- 10-inch heavy-duty foam block. • Built-in squeegee.



NOTE: Requires threaded handle, sold separately. SEE below.



ITEM NO.	PRODUCT	EACH
6387 01901	Dual-Action Scrub Brush.....	\$22.29

▶ 12 PER CASE.

ITEM NO.	PRODUCT	EACH
6387 65001	54" Threaded Plastic Handle.....	\$24.83

Swivel High-Grit Scrub® Brush

- Long-life, flared, 3/4-inch Dupont® nylon bristles.
- Innovative swiveling U-joint design. • 4-way swivel head.
- 8-inch x 3-1/2-inch high-impact plastic body.

NOTE: Requires threaded handle, sold separately. SEE BELOW.



▶ 12 PER CASE.

ITEM NO.	PRODUCT	EACH
6387 06931	Swivel Scrub®	\$51.71
6387 20111	60" Fiberglass Handle.....	23.03



Vikan® Ultra Safe Technology (UST) Deck Scrubs

With block and bristles made from the same color, you now have the highest degree of traceability possible for today's stringent HACCP environments.

- One piece design, no metal staples or resin.
- Easy to clean and dry.
- Unprecedented bristle retention.
- Easy color-coded visual inspection.
- Short stiff bristle, deck scrub design.
- Width: 16 inches.
- FDA-compliant.



ITEM NO.	COLOR
5281 00891	White
5281 00901	Yellow
5281 00911	Orange
5281 00881	Red
5281 00851	Pink
5281 00921	Purple
5281 00871	Blue
5281 00861	Green



Easy-to-clean bristle arrangement

▶ 6 PER CASE.

EACH

\$49.77

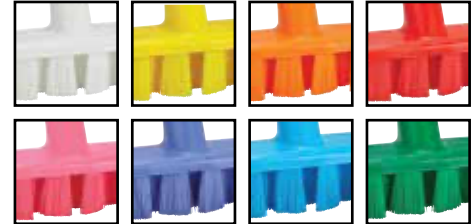

▶ SEE PAGE 111

Vikan® Color-Coded Handles. Sold separately.

Vikan® Total Color Deck Brushes

- Hygienic, solid block polypropylene construction with stiff bristles.
- Autoclavable at temperatures up to 250 °F/121 °C.
- Low water absorption polyester bristles with stainless steel staples.
- Made from FDA-compliant materials.
- Block size: 3 inches x 12 inches.



▶ SEE PAGE 111

Vikan® Color-Coded Handles. Sold separately.

ITEM NO.	COLOR
5281 16051	White
5281 0606	Yellow
5281 06071	Orange
5281 0604	Red
5281 02471	Pink
5281 06081	Purple
5281 0603	Blue
5281 04691	Lime
5281 06021	Green
H710 00801	Brown
5281 04701	Gray
5281 16091	Black

▶ 16 PER CASE.

EACH

\$39.17

▶ SEE PAGE 111



FOR
COLOR-CODED
VIKAN®
HANDLES

Vikan® Total Color High-Low Floor Brushes

You always get a clean sweep with the high-low floor brush.

- Hygienic, solid block polypropylene construction with medium bristles.
- Bristle length: 1-1/2 inches.
- Made from FDA-compliant materials.
- Block size: 5 inches x 10 inches.



▶ SEE PAGE 111
Use with Vikan®
Color-Coded Handles.
Sold separately.

ITEM NO.	COLOR
5281 04751	White
5281 04771	Yellow
5281 14771	Orange
5281 04741	Red
5281 04711	Pink
5281 02391	Purple
5281 04731	Blue
5281 03321	Lime
5281 04721	Green
H710 00781	Brown
5281 04761	Gray
5281 00361	Black

▶ 12 PER CASE.

EACH

\$25.39



Doodlebug™ Cleaning System

Pads and brushes are designed for most cleaning tasks, from light-duty cleaning of delicate surfaces to heavy-duty cleaning of dirt or finish build-up.



NOTE: Pads sold separately.



Doodlebug™ Handblock

- Convenient built-in handle puts cleaning versatility in the palm of your hand.
- Grippers hold pad firmly in place yet provide for easy attachment and replacement.

Doodlebug™ Swivel Pad Holder

- Durable holder lets holder twist and turn to reach hard-to-get places.
- Grippers hold pad firmly in place yet provide for easy attachment and replacement.
- Has threaded inlet for use with brush handle.

Doodlebug™ Cleaning System Pads

- White: light-duty; blue: medium-duty; brown: heavy-duty; black: stripping applications.
- 4-5/8 inches x 10 inches.

NOTE: Threaded handle sold separately Each holder comes with one light-duty and one heavy-duty pad.

▶ 4 PER CASE.

ITEM NO.	PRODUCT	EACH
6655 61731	Handblock Holder	\$61.63
6655 64721	Swivel Holder	65.07

ITEM NO.	PRODUCT	EACH
6387 65001	5/4" Threaded Plastic Handle	\$24.83

▶ 4 BOXES PER CASE.

ITEM NO.	PRODUCT	EACH
6655 84405	White, Light-Duty, 5/Box	\$20.07
6655 43921	Blue, Medium-Duty, 5/Box	17.45
6655 85415	Brown, Heavy-Duty, 5/Box	17.97
6655 00545	Black, Heavy-Duty Stripper, 10/Box	57.36

Vikan® Scrub Pad Holder System

Reach every corner with the pad and holder system!

- Pad holder system locks the pad firmly in place with stainless steel hooks and can be easily removed or interchanged depending on your needs.
- Pad holders are made of solid polypropylene.
- Swivel holder swivels 360°.

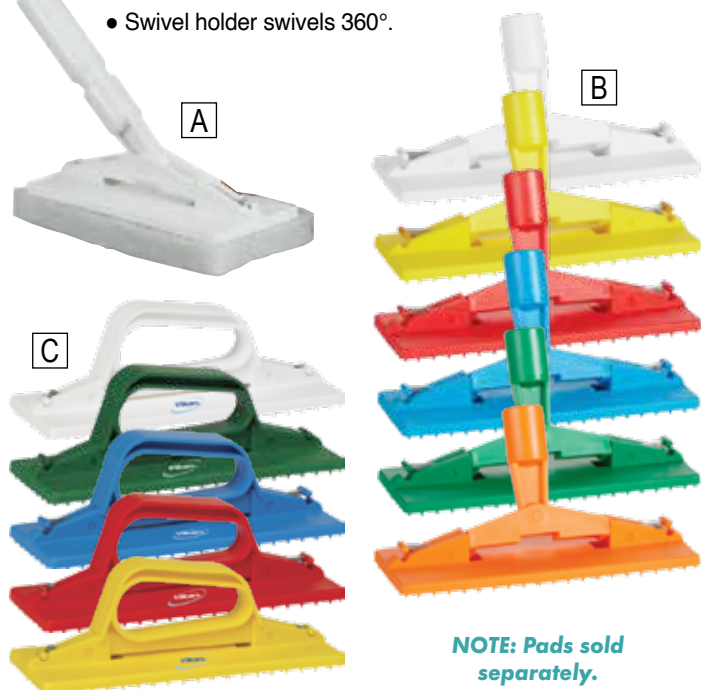

NOTE: Pads sold separately.

A. White Swivel Holder

With 60-Inch Handle

ITEM NO.	COLOR	EACH
5281 1005	White	\$66.72



B. Colored Swivel Holder

4 inch x 9 inch w/o Handle

ITEM NO.	COLOR	EACH
5281 95001	White	\$32.80
5281 50061	Yellow	
5281 50041	Red	
5281 50031	Blue	
5281 50021	Green	
H710 00491	Orange	

C. Hand-Held Holder

3-4/5 Inches x 9 Inches

ITEM NO.	COLOR	EACH
5281 5510	White	\$29.63
5281 51021	Green	
5281 5103	Blue	
5281 5104	Red	
5281 51061	Yellow	

Pads

- 10 Inches x 4-1/2 Inches x 4/5 Inches

▶ 10 PER CASE.

ITEM NO.	PRODUCT	EACH
5281 55231	Brown, Heavy-Duty Scrub Pad	\$4.20
5281 55241	Blue, Medium-Duty Scrub Pad	4.20
5281 55251	White, Light-Duty Scrub Pad	4.20



Niagara 6x9-Inch Scouring Pads

Three different strengths for every scouring need.

A. Light-Duty Scouring Pad 98N

- Ideal for stainless steel, chrome, copper, porcelain and ceramics. Won't scratch or dull surfaces.

B. Medium-Duty Scouring Pad 96N

- Cleans pots, pans and kitchen equipment. Ideal for interiors, including walls, railings, floors, stairways and counters.

C. Heavy-Duty Scouring Pad 86N

- Replaces scrapers, steel wool and metal sponges for tough jobs.

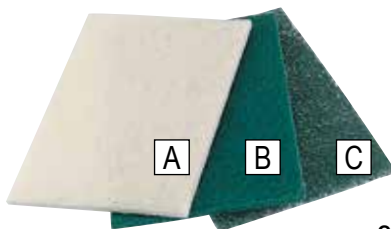

ITEM NO.	PRODUCT	QTY.	CASE
6655 9918	A. Light-Duty 98N	20 Pads/Case	\$11.46
6655 9696	B. Medium-Duty 96N	60 Pads/Case	28.78
6655 0186	C. Heavy-Duty 86N	60 Pads/Case	46.00



Niagara Medium-Duty Scrub Sponge 74N

- Dual action cleaning tool with sponge on one side and scouring pad on the other.
- Cellulose sponge wipes up spills and can carry cleaning solutions to the work surfaces.



NOTE: Sold by case only.



ITEM NO.	SIZE	CASE
6655 4874	3-1/2" x 6"	\$29.48

▶ 20 PER CASE.

Scotch-Brite™ Professional Cleaning/Scouring Pads

Heavy-Duty Scouring Pad 86

Made for tough equipment cleaning jobs.

- Replaces scrapers, steel wool and metal sponges.
- Heavy-duty nylon pads cannot rust.

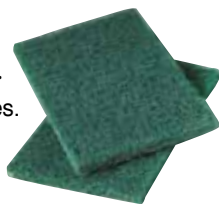

▶ 12 PADS PER BOX - 3 BOXES PER CASE.

ITEM NO.	PRODUCT	SIZE	BOX
6655 86005	Heavy-Duty Pad 86	6" x 9"	\$28.98

ITEM NO.	PRODUCT	BULK
6655 0686	Heavy-Duty Pad 86 (60 Pads/Bulk Pack)	\$75.39

Purple Scouring Pad 2020

- Scours twice as fast and scratches up to 11x less than conventional scouring pads.
- Use on pots and pans, kitchen equipment, counter tops, stainless steel and more!
- Open web design allows food debris to rinse out easily.
- Use wet or dry.



NOTE: Sold by case only.

▶ 24 PER CASE.

ITEM NO.	PRODUCT	SIZE	CASE
6655 2020	Purple Scour Pad 2020	4-1/2" x 2-9/10"	\$36.05

All-Purpose Scouring Pad 9000

All-purpose scouring pads clean without scratching.

- Specially designed for cleaning hot griddles with mirror or highly polished finishes. Ideal for porcelain, ceramic, tile, stainless steel, glass and nonstick pans.

NOTE: Sold by case only.



▶ 40 PER CASE.

ITEM NO.	PRODUCT	SIZE	CASE
6655 2955	All-Purpose 9000	4" x 5-1/4"	\$64.85

General Purpose Scouring Pad 96

Great for all those common cleaning jobs.

- Performs well on equipment, walls, railings, floors, stairways and counter tops.



▶ 20 PADS PER BOX - 3 BOXES PER CASE.

ITEM NO.	PRODUCT	SIZE	BOX
6655 96005	General Purpose Pad 96	6" x 9"	\$22.14

Power Pad 2000

- Scours 7x faster than conventional commercial scouring pads and is 10x less abrasive.
- Durable synthetic fibers that are crimped and heat set to create strong web.
- Ideal for use on stainless steel equipment and appliances.
- Comes in an easy-to-grip bow tie shape.



NOTE: Sold by case only.



▶ 20 PER CASE.

ITEM NO.	PRODUCT	SIZE	CASE
6655 2012	Power Pad 2000	5-1/2" x 3-9/10" x 2/5"	\$27.90

Stainless Steel Scrubber 84

FDA-compliant stainless steel.

- Long-lasting durability and cutting strength.
- Heavy-duty wide band construction prevents rusting, corroding and splintering, even when used with chemicals.
- 50-gram stainless steel scrubbers.



▶ 12 PER CASE.

ITEM NO.	PRODUCT	CASE
6655 0884	Stainless Steel Scrubber 84	\$36.19

Super Disposable Rags

- Ideal alternative to cloth rags and shop towels.
- Strong, durable and absorbent rags are virtually lint-free and reusable.
- 12 x 17-inch rags are 1/4 folded and come in a convenient dispenser box.



▶ 250 WIPES PER BOX.

ITEM NO.	PRODUCT	BOX
4702 0792	Disp. Multi-Purpose Rags	\$93.60

Knit Dish Cloths

- Use anywhere from kitchen to shop to car.
- Versatile cloth ideal for washing, dusting or cleaning anything.



Unique construction for durability and absorbency.

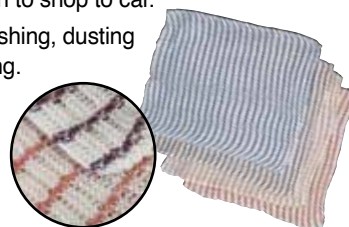

ITEM NO.	PRODUCT	DOZEN
2607 75305	Knit Dish Cloths	\$20.51

Jumbo Roll Dispenser

Jumbo Roll dispensers can hold the equivalent of 100 pounds of rags.

- Easily dispenses Jumbo Rolls of Kimberly-Clark WypAll® Wipers (sold separately).
- Rugged, high-durability construction for extended, high-capacity use.
- Compact design for use in any location.
- Available in two styles: wall-mounted or stationary.

Towel Rolls Sold Separately ▶ SEE PAGES 129-131



ITEM NO.	PRODUCT	DIMENSIONS	F.O.B. FACTORY EACH
1540 05791	A. Wall-Mounted	16-3/4" x 8-3/4" x 10-3/4"	\$52.00
1540 0596	B. Stationary Standing	18-1/2" x 16-3/4" x 33"	83.02

DON'T RISK CROSS CONTAMINATION — Use White WypAlls for Applications Involving Food Contact and Blue WypAlls for Everything Else.

X90 Shop Pro® Towels

- The highest performing wiper, provides 75% more oil absorption and 35% more water absorption.
- Super-soft wipers are ideal for heavy wiping, prepping surfaces with solvents.
- Can achieve up to 35% less product waste versus other industrial wiping solutions and 20% savings overall.



ITEM NO.	PRODUCT	COLOR	QTY.	CASE
1540 2891	Brag® Box	Blue	136 Wipes/Box, 1 Box/Case	\$71.45
1540 2889	Jumbo Roll	Blue	450 Wipes/Roll, 1 Roll/Case	232.82
1540 2890	Pop-Up® Box	Blue	68 Wipes/Box, 5 Boxes/Case	189.05

X80 Shop Pro® Towels

- As strong as a shop-towel, the X80 is engineered to feel like cloth and work even better.
- Portable boxes, so wipers can be taken to where they are needed.
- Absorbs more oil and water faster than laundered shop towels, and has no holes, strings, metal chips or residue.
- Maintains strength in solvents.



ITEM NO.	PRODUCT	COLOR	QTY.	CASE
1540 1041	Brag® Box	Blue	160 Wipes/Box, 1 Box/Case	\$49.75
1540 1043	Jumbo Roll	Blue	475 Wipes/Roll, 1 Roll/Case	99.39
1540 1049	Pop-Up® Box	White	80 Wipes/Box, 5 Boxes/Case	106.04
1540 1025	Jumbo Roll	White	475 Wipes/Roll, 1 Roll/Case	94.20

WYPALL® COMPARISON CHART

RATING: 1 (Poor) to 6 (Excellent)

TYPE	PRODUCT	TASK	SOLVENT RESISTANCE	ABSORPTION CAPACITY	WET STRENGTH	ABSORPTION RATE
Premium Rag and Shop Towel	WypAll® X90 Shop Pro®	Low-lint and critical task wiping. Abrasive surface clean. Scrubbing tools.	6	6	6	6
	WypAll® X80 Shop Pro®	Absorbs industrial-sized spills. Heavy-duty machine and part wiping. Wiping metal shavings.	5	5	5	5
	WypAll® X70 WorkHorse® Rags	Applying disinfectants. Absorbs and releases high amounts of liquids.	4	4	4	4
Economy Rag	WypAll® X60 Teri® Wipers	Cleaning equipment and surfaces. Adhesive cleaning. Applying/removing thinners and solvents.	3	3	3	3
	WypAll® X50 Wipers	Basic clean-up tasks that require durability and absorbency. Cleaning counters.	2	2	2	2
General Purpose	WypAll® L40 Wipers	Wiping face and hands. Routine cleaning and maintenance. Absorbs liquids and oils.	2	5	2	4
	WypAll® L30 Economizer®	Janitorial wiping. Wet wiping and clean-up.	2	3	2	3
Single Use	WypAll® L10 Utility Wipers	Spray and wipe jobs. Absorbs incidental spills. Cleaning smooth and glass surfaces.	1	2	1	2
Delicate	KimWipes®	Polishing surfaces. Cleaning delicate surfaces.	---	---	---	---

DON'T RISK CROSS CONTAMINATION

Use White WypAlls for Applications Involving Food Contact and Blue WypAlls for Everything Else.

X70 WorkHorse® Rags

Versatile and economical alternative to cloth, rags and towels.

- Long-lasting performance that extends usage of wipe and reduces waste.
- Pound-for-pound, absorbs more oil and water than cloth or rags.
- Cleans oil, grime and solvent with just one wipe.
- Available in Brag® Boxes, Pop-Up® Boxes or Jumbo Rolls.



ITEM NO.	PRODUCT	QTY.	CASE
1540 0737	Brag® Box	200 Wipes/Box, 1 Box/Case	\$59.95
1540 0343	Jumbo Roll.	870 Wipes/Roll, 1 Roll/Case	151.85
1540 4145	Pop-Up® Box	100 Wipes/Box, 10 Boxes/Case	224.04

X60 Teri® Wipers

Have no adhesives or binders, so they won't leave behind anything besides a clean surface.

- Designed to replace and out-perform rags, for increased sanitation and less laundering.
- Reinforced for extra scrubbing and cleaning power, but soft enough for use on the face and hands.



ITEM NO.	PRODUCT	QTY.	CASE
1540 0736	Brag® Box	252 Wipes/Box, 1 Box/Case	\$39.95
1540 0410	Small Roll, 4-Ply.	130 Wipes/Roll, 6 Rolls/Case	217.70
1540 9050	Pop-Up® Box	126 Wipes/Box, 10 Boxes/Case	146.64
1540 4955	Jumbo Roll.	1,100 Wipes/Roll, 1 Roll/Case	126.85
1540 0150	Perforated Roll.	130 Wipes/Roll, 12 Rolls/Case	200.13

X50 Wipers

- Combines versatile performance with economical design for light-duty tasks.
- Reinforced for strength when wet or dry.
- 1/4 fold wipes: 10 inches x 12-1/2 inches.
- Pop-Up box wipes: 9 inches x 12-1/2 inches.



ITEM NO.	PRODUCT	QTY.	CASE
1540 5025	1/4 Fold Wipes.	26 Wipes/Pack, 32 Packs/Case	\$73.45
1540 3550	Pop-Up® Box	176 Wipes/Box, 10 Boxes/Case	130.84
1540 5015	Jumbo Roll.	1,100 Wipes/Roll, 1 Roll/Case	92.32

L40 Wipers

General-purpose wiper is soft enough to use on face and hands.

- Light-weight double re-creped design for high-surface softness.
- Inner layer of sponge-like cells that absorb liquids, lubricants and oils quickly and efficiently.



ITEM NO.	PRODUCT	QTY.	CASE
1540 5009	Jumbo Roll.	750 Wipes/Roll, 1 Roll/Case	\$86.08
1540 0571	1/4 Fold Wipes.	56 Wipes/Box, 18 Boxes/Case	147.98
1540 5790	Pop-Up® Box	100 Wipes/Box, 9 Boxes/Case	170.69

L30 Economizer® Wipers

Light-weight wiper with a cloth-like feel.

- Strong, yet soft enough for personal use.
- Light-weight double re-creped design for high surface softness.
- Reinforced grid provides strength for wet surface wiping and cleaning.
- Available in folded packs or Pop-Up® boxes.



ITEM NO.	PRODUCT	QTY.	CASE
1540 5812	1/4 Band Folder Wipers.	90 Wipes/Pack, 12 Packs/Case	\$92.45
1540 0355	Pop-Up® Box	120 Wipes/Box, 6 Boxes/Case	98.96

L10 Utility Wipers

Strong and durable light-duty wipe.

- Perfect for spray and wipe applications or for absorption of small liquid spills.
- Convenient disposable wipe – just use it and throw it away.
- Available in Pop-Up® boxes only.
- 2,250 wipes total.



ITEM NO.	PRODUCT	QTY.	CASE
1540 5320	Pop-Up® Box	125 Wipes/Box, 18 Boxes/Case	\$168.82

KimWipes® Delicate Task Wipers

Extra low lint wiper.

- Anti-static dispensing reduces lint and electrostatic discharge.
- 1-ply. • 4-1/2 inches x 8-1/2 inches.
- 16,800 wipes total.



ITEM NO.	PRODUCT	QTY.	CASE
1540 7948	Task Wipers.	280 Wipes/Box, 60/Boxes/Case	\$274.29

FREE GROUND SHIPPING*
when you place an order for \$500 or more from THIS BUYERS GUIDE!

*FREE SHIPPING does NOT include UPS Next Day Air, UPS 2nd Day or UPS 3rd Day Select. Certain items may not qualify. This offer is good only on orders shipped UPS Ground in the 48 contiguous states. Based on dimensional weight, we will determine the most efficient means of shipment, either UPS or LTL. Products may ship by truckline.



J-Fill® QuattroSelect® Dispensing System

Wall-mounted dispensing system that accurately dispenses four different products into bottles or buckets. This system is safer, more reliable and more accurate than any other chemical dispensing platform in the industry.

- Simple bottle installation. Simply select four cleaning products from the list below.
- One-handed low flow bottle filling, or use the hose to fill a bucket.
- Remote high flow bucket/autoscrubber fill gun. • SmartValve™ product selection.
- No metering tip installation — bottles come pre-tipped to ensure dilution accuracy and cost control.
- Easy to repair, quick change manifold. • Powder-coated locking steel doors to prevent misuse.
- Product identification windows. • Drip tray with drain hose.
- Meets ASSE 1055-B back-flow prevention requirements.



- Unit Dimensions: 24-1/4 inches H x 18-1/2 inches W x 7-1/2 inches D.
- Weight: 15 pounds.
- Low Flow Rate: 1.5 gpm.
- High Flow Rate: 3.1 gpm.
- Water In-Let Hose: 4 feet.
- Remote Bucket Fill Hose: 8 feet.
- Drip Tray Drainage Hose: 8 feet.
- Water Pressure: 30-85 psi.
- Water Flow: Less than 2.0 gpm.
- Water Temperature: 50-100 °F.



Simple installation.



Remote high flow bucket/autoscrubber fill gun.



SmartValve™ product selection.



Low flow bottle filling option.

Safety Data Sheets (SDS)



Scan this QR code with your mobile device for a listing Diversey Safety Data Sheets.



Scan this QR code with your mobile device for a listing Bunzl Safety Data Sheets.

<https://bunzlhasds.appsint.com/SDSLibrary/>

ITEM NO.	PRODUCT	F.O.B. FACTORY EACH
1520 6426	QuattroSelect® w/Safe Gap	CALL FOR PRICING
1520 4386	QuattroSelect® w/Air Gap	CALL FOR PRICING

ITEM NO.	CHOOSE 4 CHEMICALS/CLEANERS FOR YOUR J-FILL DISPENSING SYSTEM	pH	DILUTION RATE	FINISHED BOTTLE	FINISHED PER CASE OF 2
1520 1512	A. Alpha-HP® Multi-Surface Cleaner	0.8	1:64	43 gallons	86 gallons
1520 0904	B. Crew® Bathroom Cleaner and Scale Remover	4.38	1:18	12.5 gallons	25 gallons
1520 8763	C. Crew® Restroom Floor/Surface SC Non-Acid Disinfectant	7.25	1:256	170 gallons	340 gallons
1520 5783	D. Glance® HC Glass Cleaner	12	1:40	27.1 gallons	54.2 gallons
1520 1690	E. Glance® NA Glass Cleaner	7	1:64	43 gallons	86 gallons
1520 0771	F. GP Forward™™ SC General Purpose Cleaner	11.4	1:128	85 gallons	170 gallons
1520 6034	G. J-512™™ Sanitizer	7.9	1:512	339 gallons	678 gallons
1520 0789	H. PERdiem® General Purpose Cleaner w/Hydrogen Peroxide	2	1:64	43 gallons	86 gallons
1520 0209	I. Spitfire® SC Power Cleaner	13.6	1:16	11.25 gallons	22.5 gallons
1520 0839	J. Stride® Citrus HC Neutral Cleaner	7.2	1:375	248 gallons	496 gallons
1520 4329	K. Virex® II 256 Germicidal Cleaner	10.2	1:256	170 gallons	340 gallons

Call 800-456-5624 For Pricing and To Order.



NOTE: All chemicals/cleaners are 2.5-liter bottle concentrates. Packaged 2 bottles per case.

Enviro Terra™ Acid Replacement Cleaner

A totally natural cleaner that combines the high performance of acids with the mildness of liquid dish soap.

- Same cleansing power of acids, without the unpleasant side effects such as skin burns and invisible toxic fumes.
- Effectively removes calcium, lime, rust and other deposits typically found in descaling and rust removal applications.
- Special clinging action allows longer dwell time on vertical surfaces – easily cleaning complex surfaces like piping, valves and crevices without leaving film or residue.
- Perfect product for manufacturing equipment, building maintenance, food services and washrooms.
- Not classified as a hazardous material. In fact, it is biodegradable.
- Non-toxic, non-corrosive, non-fuming, non-caustic and non-flammable.



Penny dipped in Enviro Terra for less than 30 seconds. No scrubbing!



Safe on skin!



Apply With Industrial Foamer
▶ SEE PAGE 158

▶ 6 BOTTLES PER CASE.

ITEM NO.	PRODUCT	GALLON
2117 01351	1-Gallon Bottle.	\$27.01

CHEMICAL INFORMATION

pH, pH (Neat)

pH is a measure of the acidity or alkalinity of an aqueous solution. Solutions with a pH less than 7 are considered acidic and solutions with a pH greater than 7 are considered to be alkaline or basic. Neat refers to a solution that is undiluted from its concentrated form.

Cationic

Refers to a solution that has greater protons than electrons resulting in a positive charge. Cationic sanitizers are self-foaming and generally used for external or environmental sanitizing.

Solvent Cleaner

Solvent cleaners are used in conjunction or as a replacement for alkaline cleaners. Solvent cleaners are good for removing oils, fats, resins and glues in the food industry.

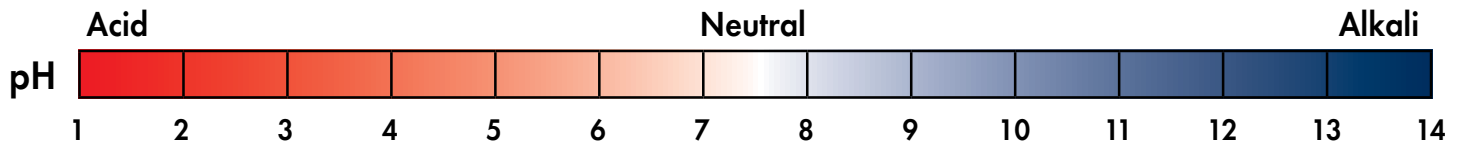

CHEMICALS: PRODUCTION AREAS

Chemical Color Code System: ●●●●●●

- **ACIDIC** — A solution that has a pH less than 7. Acidic solutions in the sanitation industry are used to remove organic soils such as mineral and scale deposits and returning shine or luster to stainless steel surfaces.
- **ALKALINE** — A solution that has a pH greater than 7. Alkaline solutions in the sanitation industry are used to remove soils such as fats, greases and proteins.
- **CHLORINATED** — Chemicals that contain sodium hypochlorite (NaOCl). This compound is contained in sanitation chemicals to remove protein soils.
- **CAUSTIC** — Caustics typically refer to cleaning chemicals that contain sodium hydroxide. These chemicals have a very high pH and are used for heavy-duty cleaning applications such as CIP, smokehouses, etc.
- **QUATERNARY** — Refers to a particular type of sanitizer containing ammonium chloride. Quat sanitizers are self-foaming and provide a bacteriostatic residual film which provides microbial defense for a period of time after it has been applied to an equipment surface.
- **MILD** — Refers to products that are a neutral pH chemical.

NSF RATING CODES

CODE	APPLICATION	CODE	APPLICATION
A1	General cleaning agents for all surfaces and areas.	D2	Partial immersion: Designed for areas with limited space. Subject to outside temperature variables.
A3	Acid Cleaners for all departments.	L2	Enzymatic compounds for use in sewer and/or drain lines.
A4	Floor and wall cleaners for use in all areas.	E1	Odorless hand washing or sanitizing compounds requiring rinse with potable water after use.
A5	Floor and wall cleaners for subfreezing temps.	E2	One step hand washing or sanitizing compounds requiring rinse with potable water after use.
A7	Metal polishes – non-food contact	E3	Hand sanitizing compounds. No rinse required after use.
A8	Degreaser and Carbon Remover for cooking and smoking equipment and related surfaces.	E4	Hand creams, lotions and cleansers. Use only when leaving plant.
B1	Laundry products – food contact.		

NO RETURN ALL ITEMS ON PAGES 134-144 ARE **NON-RETURNABLE CLEANING PRODUCTS** **NO RETURN**

HD Plusfoam

Heavy-Duty foaming caustic cleaner/degreaser for carbonized soil.

- Highly caustic, alkaline foam product for use in highly soiled areas.
- Effective as a heavy-duty smokehouse cleaner.
- Apply in areas of tenacious burnt-on soiling, such as oils fryers, ovens or smoke chambers.
- Concentrated.
- pH 13



ITEM NO.	PRODUCT	EACH
1520 5103	HD Plusfoam, 5 Gallon	\$138.06

Dibac®

Liquid chlorine sanitizer.

- Non-foaming liquid sodium hypochlorite product used to sanitize all types of food and beverage equipment.
- Concentrated.
- pH 12.4



ITEM NO.	PRODUCT	EACH
1520 6528	Dibac®, 1 Gallon, 4/Case	\$95.69
1520 6530	Dibac®, 5 Gallon	75.29
1520 6529	Dibac®, 55 Gallon	467.32

Nonstick

Acid circulation cleaner.

- Low-foaming liquid blend of acids.
- Ideal for spray and circulation cleaning.
- Effectively removes a wide variety of organic soiling and scale deposits.
- Removes hard cheese soils that stick to molds.
- Concentrated.
- pH 2



ITEM NO.	PRODUCT	EACH
1520 4012	Nonstick, 55 Gallon	\$792.02

Acifoam

Acid Foam cleaner removes scale and mineral deposits.

- Designed for daily and periodic application in food and meat processing industries.
- Concentrated.
- pH 1.8



ITEM NO.	PRODUCT	EACH
1520 6103	Acifoam, 5 Gallon	\$205.34

Easyfoam

Chlorinated foaming cleaner/degreaser.

- High-foaming chlorinated liquid detergent designed for general purpose cleaning.
- Effective on food soiling and protein removal.
- Phosphate-free.
- Concentrated.
- pH 13



ITEM NO.	PRODUCT	EACH
1520 9013	Easyfoam, 55 Gallon	\$822.71

Oxofoam

Chlorinated foaming cleaner/degreaser.

- Chlorinated foam liquid cleaner designed for daily use.
- Effective for removal of heavy fat and protein buildup.
- Can be applied via foam, spray or soak.
- Concentrated.
- pH 13



ITEM NO.	PRODUCT	EACH
1520 8013	Oxofoam, 55 Gallon	\$1,050.45

Dioklor®

Chlorinated circulation cleaner/degreaser.

- Non-phosphated, liquid chlorinated alkaline detergent designed for circulation cleaning in dairy and food processing plants.
- Concentrated.
- pH 13.8



ITEM NO.	PRODUCT	EACH
1520 6538	Dioklor®, 55 Gallon	\$684.94

NO RETURN ALL ITEMS ON PAGES 134-144 ARE **NON-RETURNABLE CLEANING PRODUCTS** **NO RETURN**

Purell® Food Processing Surface Sanitizer

Kills 99.9999% of germs on surfaces, reducing the risk of cross contamination.

- Ready to use food contact surface sanitizer delivers industry leading germ kill combined with the EPA's lowest allowable toxicity profile in an NSF D2 no-rinse food contact formula that is free of harsh chemicals and fumes.
- Alcohol only active ingredient is non-corrosive and dissipates quickly.
- Formulated with approved EPA ingredients for Food Contact Sanitizing solutions that are also recognized as GRAS Direct Food Substances by the FDA.
- Use on food and dairy processing equipment, cutting implements, conveyors, scales, sinks, counters, stainless utensils, device buttons and more! • Sanitizes gloves and footwear in 10 seconds.



ITEM NO.	PRODUCT	EACH
3540 1035	50-Gallon Drum, Clear, Lemon Scented	\$989.75
6710 00051	1-Gallon EMPTY, Unlabeled Jug	4.95
3540 06631	Purell® Surface Sanitizer Secondary Tags, 4" x 3.75"	1.95
6710 00281	Drum Pump (Not Pictured)	14.95

J-512® Sanitizer

Concentrated mild sanitizer.

- No-rinse sanitizer suitable for use in dairies, food processing, pharmaceutical, breweries and beverage operations.
- Sanitizes food contact and other hard nonporous surfaces and equipment.
- An effective bactericide, virucide and fungicide.
- Phosphate-free. • Concentrated.

pH 7.75

▶ 4 GALLONS PER CASE.



ITEM NO.	PRODUCT	CASE
1520 6669	J-512®, 1 Gallon	\$150.95

Divosan® Spectrum Sanitizer

Concentrated neutral quaternary sanitizer.

- No-rinse sanitizer for use in dairies, food processing, pharmaceutical, breweries and beverage operations.
- Sanitizes food contact and other hard nonporous surfaces and equipment.
- An effective bactericide, virucide and fungicide.
- Phosphate-free. • Concentrated.
- Dilution rate: 1 ounce per 4 gallons of water.

pH 7

▶ 4 GALLONS PER CASE.



ITEM NO.	PRODUCT	CASE
1520 6561	Divosan® Spectrum, 1 Gallon	\$94.95

TOTAL SOLUTIONS® Sanitizers

Meets EPA and USDA guidelines for D2 no-rinse sanitizer.



▶ SEE PAGES 129 -131 For Multipurpose Wipes and Towels

A. Ready-To-Use Quart Bottles

- Pre-mixed solution — just add a sprayer to the bottle and you are ready!

▶ 12 QUARTS PER CASE

ITEM NO.	PRODUCT	EACH
2117 01691	Quart Bottles (Includes 1 Trigger Sprayer w/Case Purchase)	\$5.31
6710 00071	Replacement Trigger Spray Pump, White	1.98

B. Pre-moistened Surface Sanitizing Wipes

- Pre-moistened, ready to use. • Kills 99.9% of bacteria in seconds.

ITEM NO.	PRODUCT	SIZE	QTY.	CASE/TUB
2117 5003	Canister of 100 Wipes	6" x 10"	Case of 6	\$72.77
2117 50511	Tub of 500 Wipes	6" x 8"	Each	35.70
2117 1566	Refill Rolls, 250 Wipes per Roll	6" x 8"	Case of 2	30.14

C. Vanquish "One Step" Concentrate

Disinfectant — Sanitizer — Cleaner — Fungicide — Deodorizer

- Mixed with water, one gallon bottle makes 64 gallons.

▶ 4 BOTTLES PER CASE.

ITEM NO.	PRODUCT	EACH
2117 01751	1 Gallon	\$33.54
2117 0176	55 Gallon	1,104.93



ALL ITEMS ON ► PAGES 134-144 ARE NON-RETURNABLE CLEANING PRODUCTS



Pine Brite

General purpose cleaner/deodorant.

- Pine scented.
- Effective performance.
- Excellent rinsability leaves surfaces film free.
- Concentrated.
- Dilution rate varies.



► 4 GALLONS PER CASE.

ITEM NO.	PRODUCT	CASE
6129 6737	1 Gallon.....	\$81.85

Pine-Sol® Disinfectant Cleaner

- Deodorizes, disinfects and kills 99.9% of germs.
- Concentrated.
- Dilution rate: 1/4 cup per gallon of water.
- Long lasting fresh scent.



► 6 BOTTLES PER CASE.

ITEM NO.	PRODUCT	CASE
3838 1773	60 oz.....	\$81.80

Misty® Clear Lemon Disinfectant

- One step disinfectant, germicidal detergent and deodorant.
- Biodet ND32 dual quat based.
- Concentrated.
- Dilution rate: 4 ounces per gallon of water.
- Lemon fragrance.



► 4 GALLONS PER CASE.

ITEM NO.	PRODUCT	CASE
7507 4280	Misty Lemon, 1 Gallon....	\$85.13

Mr. Clean® Antibacterial Summer Citrus™ Cleaner

- Disinfects and kills 99% of bacteria.
- Safe to use on appliances, floors and countertops.



► 9 BOTTLES PER CASE.

ITEM NO.	PRODUCT	CASE
1690 0782	28 oz.....	\$80.31

Ready-To-Use Disinfectant Cleaner

No mixing required.

- Effective as a disinfectant, cleaner, degreaser or deodorizer.
- EPA Registered disinfectant for H1N1.
- Non-acid formula is safe on most hard surfaces.



► 6 BOTTLES PER CASE.

ITEM NO.	PRODUCT	CASE
6129 6739	Disinfectant, 1 Quart.....	\$53.03

Lemon Cleaner Disinfectant

Germicidal detergent and deodorizer.

- Recommended for floors, walls and toilet facilities.
- Kills virus type 1 (HIV-1, associated with AIDS).
- Lemon scented.
- Concentrated.
- Dilution rate:1:64.



► 4 GALLONS PER CASE.

ITEM NO.	PRODUCT	CASE
1520 7668	Lemon Cleaner, 1 Gallon....	\$72.24

NO RETURN ALL ITEMS ON PAGES 134-144 ARE **NON-RETURNABLE CLEANING PRODUCTS** **NO RETURN**

3.7% Powdered Chlorine Bleach, 50 Pounds

- Cleans and removes stains.
- Safe for nylon.
- Caution: eye and skin irritant.



ITEM NO.	PRODUCT	BOX
6129 6655	Chlorine Bleach, 50 lb.	\$174.95

Liquid Chlorine Bleach

- Cleans and removes stains. • Caution: eye and skin irritant.
- Safe for nylon.



▶ 6 BOTTLES PER CASE.

ITEM NO.	PRODUCT	CASE
5000 20015	A. 5.25% Sodium Hypochlorite, 1 Gallon	\$38.06
3838 0966	B. Clorox Bleach (3/Case), 121 oz.	107.68

Misty® Foaming Disinfectant

Hospital-type, quat-based disinfectant cleaner and deodorizer.

- When used as directed, it kills Staph, Salmonella, Pseudomonas and HIV-1 AIDS virus on hard surfaces.
- High-foaming action with excellent cleaning power.
- 360° valve allows can to spray upside down.
- Effective against antibiotic-resistant strains VRE, VISA, VRSA, MRSA, and CA-MRSA.



WARNING: See page 2. www.P65Warnings.ca.gov

▶ 12 CANS PER CASE.

ITEM NO.	PRODUCT	CASE
7507 5020	20 oz. Aerosol Spray	\$95.04

Clorox® Clean-Up Bleach

- Disinfects and kills 99.9% of bacteria.
- Kills viruses that cause colds and flu.
- Removes tough stains, grease and grime.

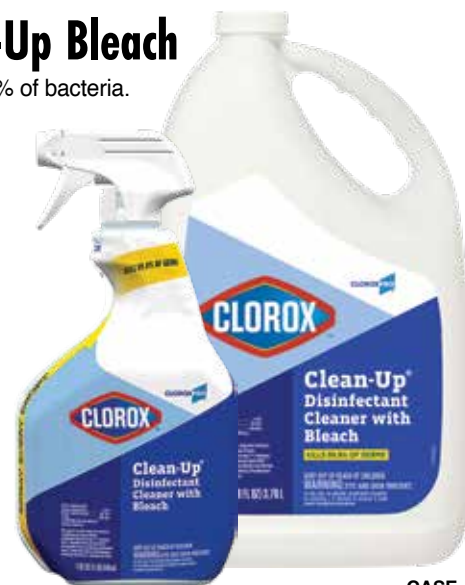

ITEM NO.	PRODUCT	CASE
3838 1266	32 oz. (9 Bottles/Case)	\$76.24
3838 1250	1 Gallon (4 Bottles/Case)	92.07



FREE GROUND SHIPPING
when you place an order for \$500
or more from **THIS BUYERS GUIDE!**

*FREE SHIPPING does NOT include UPS Next Day Air, UPS 2nd Day or UPS 3rd Day Select. Certain items may not qualify. This offer is good only on orders shipped UPS Ground in the 48 contiguous states. Based on dimensional weight, we will determine the most efficient means of shipment, either UPS or LTL. Products may ship by truckline.

NO RETURN ALL ITEMS ON PAGES 134-144 ARE **NON-RETURNABLE CLEANING PRODUCTS** **NO RETURN**

All-Purpose Liquid 707 Cleaner/Degreaser

For general cleaning anywhere heavy grease is a problem.

- Cuts through oils and greases.
- Pine-floral scented. • Institutional strength.
- Solvent based. • Concentrated.
- Dilution rate: Versatile with many dilutions and applications.



▶ 4 GALLONS PER CASE.

ITEM NO.	PRODUCT	CASE
6129 6699	1 Gallon	\$72.30

Terrifico™ General Purpose Cleaner/Degreaser

- For general cleaning of floors, walls, kitchen equipment and hoods and anywhere heavy grease is a problem.
- Lavender-pine scent provides a pleasant work environment.
- Institutional strength.
- Low use cost. • Solvent based.
- Cuts through oils and greases.
- Concentrated.
- Dilution rate: 1 ounce per 1-1/2 gallons of water.



▶ 4 GALLONS PER CASE.

ITEM NO.	PRODUCT	CASE
6129 6752	1 Gallon	\$94.95

Quickline™ T-A-P Orange™

Citrus neutral cleaner.

- Heavy-duty degreaser/cleaner in a convenient, ready-to use form.
- Free rinsing — use on any surface not harmed by water.
- Citrus fragrance.



▶ 6 BOTTLES PER CASE.

ITEM NO.	PRODUCT	CASE
6129 6692	1-qt. Spray Bottle	\$80.83

Hi-Voltage Degreaser

50 pounds makes 2,000 gallons of cleaning solution.

- Removes grease and fat accumulations quickly and thoroughly.



ITEM NO.	PRODUCT	EACH
3032 3700	10 lb Box	\$29.95
3032 3701	50 lb Box	139.95

Quickline™ Showdown™

All purpose cleaner and degreaser.

- Controlled foaming for less wiping.
- Aggressive solvent formula — compare to 409.
- Free rinsing — use on any surface not harmed by water.



▶ 6 BOTTLES PER CASE.

ITEM NO.	PRODUCT	CASE
6129 6691	1-qt. Spray Bottle	\$60.01

SHOP 24/7
bunzlpd.com

Where you can find out what's on sale, find updated product information, reviews and pricing.



Need Help?
Chat With Us
Online!

STAY CONNECTED WITH US:



NO RETURN ALL ITEMS ON PAGES 134-144 ARE **NON-RETURNABLE CLEANING PRODUCTS** **NO RETURN**

Oven, Grill and Smokehouse Cleaner

Removes grease, soot, tar and other accumulations from smokehouse walls, floors and ceilings.

- With a pH of >12.5 and caustic formulation, it offers the performance of traditional caustic oven, grill and smokehouse cleaners.
- Thickened formula sticks to vertical surfaces to allow for longer dwell time and better cleaning.
- Highly effective on grease, fats, oils, carbon, dirt and baked-on deposits on food prep and cooking surfaces such as ovens, grills, deep fryers, smokehouses and meat curers.
- Keep away from heat, open flames, sparks.
- Biodegradable.



ITEM NO.	PRODUCT	CASE
2117 0433	1-Gallon Bottles (4/Case)	\$80.53
2117 0434	5-Gallon Pail	106.15

H.D. Oven and Grill Cleaner

- Ready to use; no mixing required.
- Powerful Alkaline formula removes burnt-on food, grease and animal fats.
- Use on ovens, grills and stove tops.



▶ 4 BOTTLES PER CASE.

ITEM NO.	PRODUCT	CASE
6129 6718	1 Gallon	\$96.04

Powder Fryer Cleaner

For use only in deep fat fryers.

- Non-abrasive. Does not scratch surfaces.
- Alerts operator to neutralize the surface.
- No scent. Non-foamer.
- Free flowing powder.
- Applied with a long handled brush.
- Concentrated.
- Dilution rate:
Straight to 2-3 ounces per gallon of water.



▶ 4 BOXES PER CASE.

ITEM NO.	PRODUCT	CASE
6129 6717	3-3/4 lb Box	\$76.39

Freezer Cleaner

Safe, effective concentrate for cleaning frozen food processing areas.

- Cleans at temperatures down to -44 °F.
- Odorless. • Fast acting
- Corrosion inhibitors.
- Dilution rate: 1:1 or use straight.



▶ 4 BOTTLES PER CASE.

ITEM NO.	PRODUCT	CASE
6129 6714	1 Gallon	\$178.19

Quickline™ TKO™ Oven and Grill Cleaner

- Ready to use; no mixing required.
- Powerful Alkaline formula removes burnt-on food, grease and animal fats.
- Use on ovens, grills and stove tops.



▶ 6 BOTTLES PER CASE.

ITEM NO.	PRODUCT	CASE
6129 6693	1-qt. Spray Bottle	\$66.62

Roubaix™/MC Multi-Purpose Cleaner/Degreaser



Great for meat room cleaning.

- A blend of wetting agent and emulsifying agents gives it the ability to penetrate even the toughest soils.
- Solventized cleaner with all the characteristics of a detergent plus solvent to help degrease and clean tougher soils.
- Can be sprayed or foamed on surfaces to be cleaned.
- Safe on most surfaces.
- Anionic liquid for general purpose medium to heavy-duty applications.
- Concentrated.
- Dilution rate varies.

● pH 11.85



ITEM NO.	PRODUCT	EACH
1520 1455	5-Gallon Pail	\$136.87
1520 1412	55-Gallon Drum	717.65

NO RETURN ALL ITEMS ON ► PAGES 134-144 ARE **NON-RETURNABLE CLEANING PRODUCTS** **NO RETURN**

Stride® Citrus Neutral General Purpose Cleaner

Green Seal™ certified non-alkaline general purpose cleaner does not require rinsing.

- Bag in a box cleaner with pleasant citrus scent.
- Neutral pH, so it cleans without damage.
- Cleans nearly all washable surfaces.
- Can be used in buckets, spray bottles or in automatic scrubbing machines because it is a low foaming product.
- Concentrated.
- Dilution rate varies.



ITEM NO.	PRODUCT	EACH
1520 3908	5-Gallon Box	\$52.95

TOTAL SOLUTIONS® Multi-Purpose Towels

- Versatile, waterless cleaner cuts through tar, grease, wax, paint, lubricants and adhesives.
- Non-scratching, towels contain emollient and natural oils so they won't crack or dry skin.
- Can use instead of soap and water and won't leave filmy residue.



► 6 CANISTERS PER CASE.

ITEM NO.	PRODUCT	EACH
2117 15391	70-Wipe Canister	\$24.45

GP Forward™/MC General Purpose Cleaner

- High-performance, all-purpose commercial cleaner for use on all water-safe surfaces.
- Removes most dirt, grit, grease and soap scum without leaving behind any film or residue.
- Pleasant citrus scent. • No rinsing required



► 4 BOTTLES PER CASE

ITEM NO.	PRODUCT	CASE
1520 4519	GP Forward™/MC, 1 Gallon	\$81.35

PERdiem® General Purpose Cleaner with Hydrogen Peroxide

Multi-use cleaner/degreaser

- Concentrated general purpose cleaner based on Accelerated Hydrogen Peroxide (AHP) technology for high-productive cleaning.
- Phosphorous-free.
- Effective general purpose cleaning for oils and fats on most surfaces.
- Concentrate.
- Dilution rate varies.

● pH 2



► 4 GALLONS PER CASE.

ITEM NO.	PRODUCT	CASE
1520 0786	PERdiem®, 1 Gallon	\$178.95

Challenge General Purpose Cleaner

- Safely and effectively removes animal grease and blood soils.
- Requires rinse with potable water if used in food processing areas.
- Low odor and pleasant to use.



► 4 GALLONS PER CASE.

ITEM NO.	PRODUCT	CASE
6129 6703	1 Gallon	\$109.15

Shureclean Plus™/MC

Neutral foaming general purpose cleaner.

- Neutral, high-foaming liquid detergent
- Effective general purpose cleaning for oils and fats on most surfaces.
- Concentrate.

● pH 5.8



ITEM NO.	PRODUCT	EACH
1520 3102	Shureclean Plus™/MC, 5 Gallon	\$153.40

NO RETURN ALL ITEMS ON PAGES 134-144 ARE **NON-RETURNABLE** CLEANING PRODUCTS **NO RETURN**

Spic And Span® Floor Cleaner with Bleach

- 2- in-1 cleaning and sanitation, saves time and labor.
- Caution: eye and skin irritant.



▶ 45 PER CASE

ITEM NO.	PRODUCT	CASE
1690 2010	2.2 oz.	\$94.75

Suma® Stop Slip™/MC Traction Treatment

- Wet look with durability and resistance to scuffs.
- Concentrate. • Dilution rate: 1:4 with water.



▶ 4 BOTTLES PER CASE

ITEM NO.	PRODUCT	CASE
1520 4678	1 Gallon	\$115.51



Progress™ Carpet Extraction and Bonnet Cleaner

- Low-foaming carpet cleaner.
- Concentrate formulated for hot water extraction or "steam" cleaning machines.
- Contains optical brighteners to improve carpet appearance.
- Safe for use on color-fast carpets, rugs and fabrics.



▶ 4 BOTTLES PER CASE

ITEM NO.	PRODUCT	CASE
6129 6682	1 Gallon	\$131.11

Carefree® Floor Finish/Sealer

Simplifies floor care programs.

- For all floor types.
- Works with any equipment.
- Meets ASTM D-2047 slip-resistance requirements.



▶ 4 BOTTLES PER CASE

ITEM NO.	PRODUCT	CASE
1520 5432	1 Gallon	\$314.54



Misco Genesis™ GX-2004+ Ultra High Speed Floor Finish

- High solids resulting in fewer coats required. • Acts as a sealer and a finish.
- Very durable and designed for high traffic areas.
- Selective maintenance — can be burnished if desired.

ITEM NO.	PRODUCT	BOX
6129 6677	5 Gallons	\$211.31

Misco Genesis™ Heavy-Duty Floor Stripper

- Heavy-duty formula for the toughest floor finishes. • Speed stripping action requires very little scrubbing.
- Non-ammoniated. • Concentrate. • Dilution rate: 1:11 with water.



ITEM NO.	PRODUCT	EACH
6129 6679	5 Gallons	\$215.89



NO RETURN **ALL ITEMS ON ► PAGES 134-144 ARE NON-RETURNABLE CLEANING PRODUCTS** **NO RETURN**

Handy Man Drain Cleaner and Opener

Ready to use formula.

- Pour 16 ounces or 1/2 bottle to unclog drain.
- Powerful, fast acting alkaline formula saves labor and time.
- Heavier than water. Displaces water over clogs.



► 12 BOTTLES PER CASE.

ITEM NO.	PRODUCT	CASE
6129 6720	1 qt.	\$180.18

Bacterial Digestant

Ready to use formula. Use 10-20 ounces per night for effective drain maintenance.

- Effectively combats clogs caused by soap, hair, food, grease and other common wastes.
- Safe and easy to use in all plumbing and septic systems.
- Eliminates odors and prevents drain clogs.



ITEM NO.	PRODUCT	CASE
6129 6701	1 Gallon (4/Case)	\$107.93
6129 6702	5 Gallons	208.65

Brite Stainless Steel Polish

- Water-based formula cleans, shines and protects.
- Use on chrome, aluminum, brass and copper.



► 12 CANS PER CASE.

ITEM NO.	PRODUCT	CASE
7500 4062	Aerosol, 16 oz.	\$73.23

Stainless Steel Polish

- Liquid polish.
- Non-abrasive won't scratch surfaces.
- Spearmint scented.
- Provides protective coating.
- Non-flammable.
- Aids in soil removal.

► 6 BOTTLES PER CASE.

ITEM NO.	PRODUCT	CASE
6129 6748	Liquid, 32 oz.	\$152.97



Flare Stainless Steel Cleaner and Polish

- Oil-based formulation helps seal out corrosion.
- Restores original brilliance to stainless steel.



► 12 CANS PER CASE.

ITEM NO.	PRODUCT	CASE
7500 4061	Aerosol, 15 oz.	\$84.91

Glaze Lemon Furniture Polish

- Protects furniture against water marks, scratches and stains.
- Blend of beeswax and carnuba wax.
- May also be used on plastic and vinyl.

► 12 CANS PER CASE.

ITEM NO.	PRODUCT	CASE
7500 4065	Aerosol, 20 oz.	\$71.18



NO RETURN ALL ITEMS ON PAGES 134-144 ARE **NON-RETURNABLE CLEANING PRODUCTS** **NO RETURN**

Limón Pot and Pan Detergent

Powerful grease cutting formula with a pleasant lemon scent.

- Super-concentrated formulated for handwashing and ideal for the greasiest dishes, glassware, cutlery, pots and pans, utensils and glassware.
- Super-concentrated, high-sudsing dishwashing formula is great at cutting through grease.
- For institutional and food service environments.
- Provides dish liquid with long-lasting suds and outstanding cleaning performance.
- Specially-formulated to leave sink areas smelling clean and fresh.
- pH balanced to be gentle on hands.
- Rinses clean for a great shine.



▶ 2 BOTTLES PER CASE.

ITEM NO.	PRODUCT	CASE
1520 1993	1 Gallon	\$49.95

Dawn® Manual Pot and Pan Detergent

- Tough on grease.
- Fast-activating formula.



ITEM NO.	PRODUCT	CASE
1690 5112	38 oz. (8/Case)	\$92.95
1690 0339	1 Gallon (4/Case)	144.70

Lime-Out Delimer/Descaler

Concentrated cleaner designed especially for dishwashing machines.

- Safely and effectively dissolves and removes lime scale buildup dishwashers and other kitchen equipment.
- Green color; no fragrance. • Multi-use concentration.
- Dilution rate: Straight to 2 ounces per gallon of water.



▶ 4 BOTTLES PER CASE.

ITEM NO.	PRODUCT	CASE
6129 7359	1 Gallon	\$194.54

Special Pink Detergent

Light-duty equipment and pot and pan detergent.

- Neutral pH formula. • Mild to the hands.
- Pink color. • Pleasant lemon scent.
- No corrosion. • Safe on all surfaces.



▶ 4 BOTTLES PER CASE.

ITEM NO.	PRODUCT	CASE
6129 6746	1 Gallon	\$67.71

Scotch-Brite™ All-Purpose Scouring Pad 9000

All-purpose scouring pads clean surfaces without scratching.

- Thick, hand-size scouring pad cleans most types of surfaces without scratching. Specially designed for cleaning hot griddles with mirror or highly polished finishes. Ideal for porcelain, ceramic, tile, stainless steel, glass and nonstick pans.
- Can be used with Scotch-Brite™ Multi-Purpose Pad Holder or 3M™ Twist-Lok Pad Holder (both sold separately).



NOTE:
Sold by case only.

▶ 40 PADS PER CASE.

ITEM NO.	PRODUCT	SIZE	CASE
6655 2955	All-Purpose 9000	4" x 5-1/4"	\$64.85

Scotch-Brite™ Stainless Steel Scrubber 84

FDA-approved stainless steel.

- Heavy-duty wide band construction prevents rusting, corroding and splintering, even when used with chemicals.
- Long-lasting durability and cutting strength.
- 50-gram stainless steel scrubbers.



Heavy-duty, wide band construction.



▶ 12 PER CASE.

ITEM NO.	PRODUCT	CASE
6655 0884	Stainless Steel Scrubber 84	\$36.19

NO RETURN ALL ITEMS ON ► PAGES 134-144 ARE **NON-RETURNABLE CLEANING PRODUCTS** **NO RETURN**

TOTAL SOLUTIONS® Glass Wipes

One step glass cleaner.

- Pre-moistened alcohol- and ammonia-free wipes remove dust, dirt, oil and grease smudges, water spots, fingerprints and smoke film from any glass surface.
- Won't leave behind streaks or sticky film that can cloud visibility.
- Non-flammable, no VOC's and is safe on just about any surface including colored or tinted windows.

► 70 WIPES PER DISPENSER - 6 PER CASE.



ITEM NO.	PRODUCT	EACH
2117 15581	Glass Wipes	\$12.75

Hi-Valu Laundry Detergent, 40 Pounds

- An economical but effective, high-efficiency powdered laundry detergent for all types of machine washable laundry.
- Gives a high degree of alkalinity to the suds cycle water allowing more complete soil removal.
- Citrus fragrance.



ITEM NO.	PRODUCT	EACH
7300 0043	40 lb Bucket	\$118.15

All Temperature Powdered Laundry Detergent, 50 Pounds

- May be used in commercial and domestic washers.
- Controlled foaming. • Fresh lemon fragrance.
- Concentrated. • Dilution rate: 3/4 cup per 50 pound load.



ITEM NO.	PRODUCT	EACH
6129 6700	50 lb Box	\$108.93

Glass Cleaner

Ready-to-use formula.

- Can be used as an all purpose cleaner, eliminating need for multiple chemical.
- Heavy-duty, streak-free cleaning.
- Helps control dust and fingerprints.
- Non-ammonia with no harsh odors; may be used on plexiglass surfaces.
- Aerosol: Hazmat.



HAZMAT

► AEROSOL: 12 PER CASE ► GALLON: 4 PER CASE.

ITEM NO.	PRODUCT	CASE
7500 4049	Aerosol, 19 oz.	\$50.05
7500 4051	1 Gallon	43.66



Laundry Detergent Powder, 25 Pounds

Economical, biodegradable, low phosphate.

- Optical brighteners and borax stain removers for grease and soiled laundry.
- Water softening ingredients assure excellent performance even in hard water.
- Pleasant lemon scent.



ITEM NO.	PRODUCT	EACH
2117 2126	25 lb Bucket	\$106.22



SIGN UP FOR OUR eDEALS

Get exclusive offers not found anywhere else!

eDEAL SIGN-UP FORM AVAILABLE ON OUR WEBSITE.

www.bunzlpd.com

24-Ounce Spray Bottles

- 9-3/4-inch dip tube.
- Bottles can easily be marked to identify contents.
- Adjustable spray pattern with full off position.
- Replacement pump available (sold separately, listed below)
- Chemical resistant.



Bottles are labeled with safety information and bilingual check off grid (printed in English/Spanish)

ITEM NO.	PRODUCT	EACH
6710 01205	24-oz. Spray Bottles, Each with Spray Pumps (3/Pack)	\$10.31
6710 02461	Replacement Trigger Spray Pump, Red	1.95
6710 00071	Replacement Trigger Spray Pump, White	1.98

32-Ounce Spray Bottle

- 9-3/4-inch dip tube.
- Adjustable spray pattern with full off position.
- Chemical resistant.



Bottles have embossed graduations marks with dilution rates.

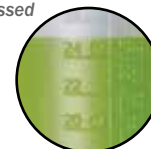

ITEM NO.	PRODUCT	EACH
6710 01251	32-oz. Graduated Spray Bottle	\$3.11
6710 00071	Replacement Trigger Spray Pump, White	1.98

Deluxe Carry Caddy

- Holds up to eight 32-ounce spray bottles.
- Ergonomic handle design.



Ideal for carrying cleaning supplies. Sold separately.

ITEM NO.	PRODUCT	EACH
1770 54001	Deluxe Carry Caddy	\$23.65

Pump Dispensers for Gallon Bottles

- Pumps from 0.25 ounce to 1 ounce.
- Pump fits any 1 gallon bottle.



ITEM NO.	PRODUCT	EACH
6710 61001	1 oz.	\$2.95
6710 11091	0.25 oz.	3.07

ELIMINATE Cross Contamination



Solution covers sole, sides and arch area.



Mat grip pattern provides non-slip surface.

► WWW.BUNZLPD.COM
Additional Boots, Shoes, Insoles and Boot Wash Accessories

High-Wall Disinfectant Boot Dip Mat

2-inch wall height, solutions cover sole, sides and welt/arch of boot.

- Use wherever cross-contamination is a concern.
- Holds up to 22 quarts of solution.
- Mixed with water, one bottle makes 64 gallons — enough solution to fill mats over 11 times!

NOTE: We recommend Total Solutions "One Step" Sanitizer. SEE BELOW.

ITEM NO.	PRODUCT	DIMENSIONS	EACH
4480 3239	Boot Dip Mat	.32' x 39" x 2"	\$115.45

TOTAL SOLUTIONS® Vanquish "One Step"

Disinfectant, sanitizer, cleaner, fungicide and deodorizer

- Mixed with water, one gallon bottle makes 64 gallons!
- Meets EPA and USDA guidelines for D-2 rated sanitizers.



ITEM NO.	PRODUCT	EACH
2117 01751	1 Gallon	\$33.54
2117 0176	55 Gallon	1,104.93



Watersaver Junior Insulated Nozzle

Less than 2/3 the weight of a standard industrial nozzle.

- Variable spray pattern. • Water saving nozzle, low rate: 5 gpm.
- Constructed of bronze and stainless steel.
- Insulated black rubber cover with yellow directional arrows.
- Instant shut off when trigger is released.
- Rated at 150 psi, up to +180 °F.



SWIVEL INCLUDED! Ready to connect to standard male GHT.

VARIABLE SPRAY NOZZLES

Trigger lever controls variable spray pattern.



Wide spray. Narrow spray. Tight stream.

ITEM NO.	PRODUCT	EACH
3566 11511	Nozzle and Swivel, 3/4" GHT.	\$104.95
3013 10121	Repl. Swivel Adaptor, 3/8" male NPT x female GHT ...	24.25

Hog Wash Nozzle

Designed for use with cold water.

- Replaceable 2-inch bronze shower head.
- Maximum washing pressure: 200 psi. • Overall length: 8 inches.
- Connects directly to 3/4-inch ID hoses.
- Automatically shuts off when handle is released.



ITEM NO.	PRODUCT	EACH
4503 9151	Bronze Shower Nozzle	\$144.95

Stainless Steel Hose Clamp

- For use with barb adaptors.
- Adjustable 7/16 inch to 1 inch.



ITEM NO.	PRODUCT	EACH
3095 0553	Stainless Steel Hose Clamp	\$2.95

Light-Weight Aluminum Spray Nozzle

Cost-saving industrial spray nozzle.

- Variable spray pattern. • Insulated replaceable rubber cover.
- Instant shut-off when trigger is released. • Weight: 1-4/5 pounds.
- Rated at 150 psi, up to +180 °F, flow rate: 7 gpm.



We recommend use with a 1/2-inch NPT x female GHT, swivel adaptor, sold separately.

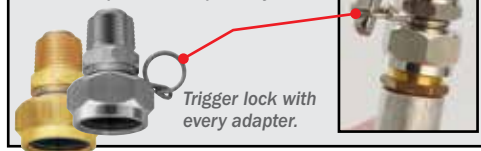

ITEM NO.	PRODUCT	EACH
3566 01511	Aluminum Nozzle.	\$112.45
3566 9122	Replacement Rubber Cover	50.95
3566 09661	Replacement Barrel Assembly	35.75
3013 10111	Opt. Brass Swivel Adapter 1/2" male NPT x 3/4" female GHT. .	25.35
3013 00111	Opt. Stainless Steel Swivel Adapter 1/2" male NPT x 3/4" GHT	31.15

Plastic Shower Nozzle

Designed for use in food service and processing industry.

- Washers and o-rings are made from high temperature resistant Viton material.
- Highly corrosion resistant.
- Leak-proof with ergonomic handle.
- Light-weight and durable.
- Rated at 185 °F (85 °C). Maximum water pressure 100 psi.

SANI-LAV
COLUMBIA PRODUCTS



ITEM NO.	PRODUCT	EACH
3013 10031	Orange	\$110.85
3013 10171	White	110.85



Insulated Hot Water Nozzles

Ideal for industrial use with hot or cold water.

- NOT for high pressure. Rated at 100 psi, up to 180 °F (82 °C).
- Insulated, molded santoprene grip for comfort.
- Instant shut off at nozzle.
- Rust-resistant stainless steel spring.
- Male hose threaded front for attaching accessories.
- Use with city water pressure only. NOT for high pressure.
- Water-saver flow control.

Standard-Duty Nozzle with Plastic Handle

- Brass stem.

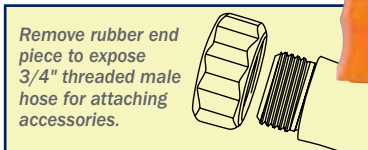
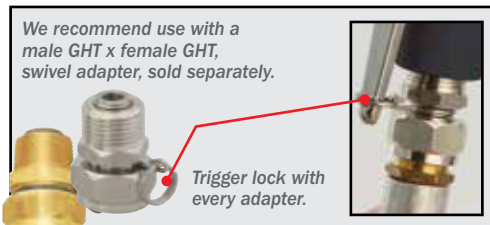

ITEM NO.	COLOR
3013 30021	Orange
3013 40231	Black
3013 40241	White
3013 40251	Red
3013 40261	Blue
3013 40271	Green
3013 40281	Yellow

EACH
\$13.75

ITEM NO.	PRODUCT	EACH
3013 00171	Optional Brass Swivel Adapter, Male GHT x Female GHT	\$26.55
3013 21031	Optional Stainless Steel Swivel Adapter, Male GHT x Female GHT	35.93



Heavy-Duty Nozzle with Stainless Steel Handle

Stainless steel handle allows for more heavy-duty applications.



Remove rubber end piece to expose 3/4" threaded male hose for attaching accessories.



ITEM NO.	COLOR
3013 22021	Orange
3013 22181	Black
3013 22171	White

EACH
\$49.65

VARIABLE SPRAY NOZZLES

Trigger lever controls variable spray pattern.

Wide spray.

Narrow spray.

Tight stream.



Straight Nozzle

- Easily attaches to any standard hose.
- 6.6 mm, 10 gpm.
- Triggerless design for ease of handling and direct spraying capability.



Female GHT x Male GHT.



ITEM NO.	PRODUCT	EACH
3013 00141	Straight Nozzle, Includes On/Off Valve	\$43.95
3013 10161	Replacement Brass Valve	31.15
3013 21021	Replacement Stainless Steel Valve	73.95





M-70 Series Nozzles



Our premium heavy-duty industrial spray nozzle.

- Insulated replaceable rubber cover. • Variable spray pattern.
- Rated at 150 psi, +180 °F, flow rate: 7 gpm. • Field repairs are quick and easy.
- Instant shut-off when trigger is released. • Weight: 2.9 pounds.

ITEM NO.	PRODUCT	EACH
3047 0070	M-70 Nozzle w/Black Cover	\$229.15
3047 0075	M-75 Nozzle w/White Cover	229.15
3047 00691	M-77 Nozzle w/Red Cover	229.15
3095 0553	Stainless Steel Hose Clamp	2.95
3013 10111	Opt. Brass Swivel Adapter 1/2" NPT x Female GHT	25.35
3013 00111	Opt. Stainless Steel Swivel Adapter 1/2" NPT x Female GHT	31.15



We recommend use with a 1/2 inch NPT x female GHT, swivel adapter, sold separately.

Trigger lock with every adapter.



▶ SEE PAGE 151
Item# 3095 0553

Attach to standard garden hose with stainless steel hose clamp, sold separately.

M-70 Series Replacement Parts

ITEM NO.	PRODUCT
3047 0020	A. Replacement Cover, Black
3047 1020	Replacement Cover, White
3047 0026	Replacement Cover, Red
3047 0072	B. Replacement Body
3047 4167	C. Replacement Lever Arm
3047 4168	D. Replacement Stainless Steel Seat
3047 4174	E. Replacement Lock Screw
3047 4175	F. Replacement Stem Guide
3047 0032	G. Replacement Body Sealing O-Ring
3047 4171	H. Replacement Lever Arm Screw
3047 01031	I. Replacement Cartridge and Cage
3047 2100	J. 1/2" Barrel Type Adapter
3047 4170	K. Replacement Lever Arm Bushing



Vikan® Spray Gun

By applying a variable amount of tension on the rubber insulated trigger, the user can control the pressure of the water jet.

- Suitable for many cleaning applications including rinsing off work surfaces and walls after chemical foaming.
- The water jet can also be adjusted using the screw at the end of gun.
- An arrow on the water gun indicates the spray direction of the water jet.
- 5-7/10 inches L x 7-1/10 inches W x 2-1/4 inches H.
- Maximum Temperature: 203 °F. • Rubber on brass/stainless steel body.



ITEM NO.	COLOR	EACH
5281 00331	White	\$148.45
5281 03591	Yellow	
5281 00321	Red	
H710 00871	Blue	
5281 01451	Green	
5281 03381	Black	



Swivel-Pro Hose Adapter

Increases nozzle control and flexibility, while maximizing operator comfort and safety.

- Allows circular, horizontal and vertical movements of the nozzle without repositioning heavy hose.
- Minimizes stress on the wrist and forearm.
- Rubber coated boot for additional heat protection.
- For applications up to 50 psi and 200 °F.



Swivel-Pro adaptor allows for rotation and pivoting motion for ease of nozzle use.



ITEM NO.	PRODUCT	F.O.B. FACTORY EACH
3047 9012	1/2"	\$214.75
3047 9013	5/8"	214.75
3047 9014	3/4"	214.75

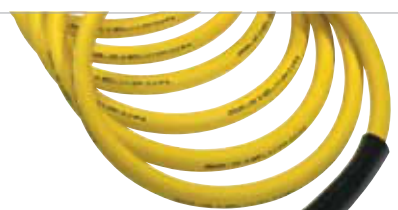

NEED HOSE?
From General purpose to reinforced hot water — we've got the right hose for you!

For Hoses ▶ SEE PAGES 152-153

Mid-Sized Hot Water Nozzles

Designed for use in the food processing industry and built to withstand the harshest working conditions.

- Heavy-duty body with stainless steel and brass components.
- Replacement parts available. • 3/4-inch female GHT.
- Trigger controlled variable spray pattern that instantly shuts off when trigger is released.
- Insulated rubber cover with direction arrows.
- Maximum water temperature: 200 °F/93 °C
- Maximum working pressure: 150 psi. • Flow rates: 2.5 - 7 gpm.



SANI-LAV
COLUMBIA
PRODUCTS

VARIABLE SPRAY NOZZLES

Trigger lever controls variable spray pattern.



Wide spray.



Narrow spray.



Tight stream.

Brass Body

ITEM NO.	COLOR	EACH
3013 30011	Orange	
3013 21001	White	
3013 21011	Black	
3013 00951	Red	
3013 00971	Yellow	\$84.25

Aluminum Body

ITEM NO.	COLOR	EACH
3013 89011	Orange	
3013 89031	White	
3013 89021	Black	
3013 01271	Red	
3013 01241	Yellow	\$75.05

Stainless Steel Body

and Components

ITEM NO.	COLOR	EACH
3013 89111	Orange	
3013 01171	White	
3013 01191	Black	
3013 01001	Red	
3013 01151	Yellow	\$116.13

Mid-Sized Nozzle Replacement Parts

ITEM NO.	PRODUCT	EACH
3013 27001	A. Barrel Replacement Kit for Brass Models.	\$43.95
3013 01621	Barrel Replacement Kit for Stainless Steel Models	69.25
3013 27021	B. Handle Replacement Kit for Models N1, N1B and N1W	24.25
3013 27011	C. Replacement Cover for Non-Threaded Tip Nozzles, Safety Orange.	35.75
3013 94611	Replacement Cover for Non-Threaded Tip Nozzles, Black	35.85
3013 01761	Replacement Cover for Non-Threaded Tip Nozzles, White	35.85
3013 01831	Replacement Cover for Non-Threaded Tip Nozzles, Red	35.85
3013 00921	Replacement Cover for Threaded Tip Nozzles, Safety Orange	32.35
3013 01821	Replacement Cover for Threaded Tip Nozzles, Black	32.35
3013 01811	Replacement Cover for Threaded Tip Nozzles, White	32.35
3013 01871	Replacement Cover for Threaded Tip Nozzles, Red	32.35
3013 21031	D. Stainless Steel Swivel Adapter	35.93
3013 00171	E. Brass Swivel Adapter	26.55



Large Heavy-Duty Insulated Hot Water Spray Nozzles



Brass swivel hose barb INCLUDED!

5 gpm

ITEM NO.	COLOR
3013 00121	Safety Orange
3013 00081	White
3013 00091	Black
3013 01721	Red

9 gpm

ITEM NO.	COLOR
3013 00071	Safety Orange
3013 00051	White
3013 00061	Black
3013 01711	Red

EACH
\$172.45

Large Nozzles Replacement Parts

ITEM NO.	PRODUCT	EACH
3013 01631	A. Barrel Replacement Kit.	\$61.15
3013 01611	B. Handle Replacement Kit.	39.25
3013 01791	Cover, Safety Orange	38.05
3013 01781	Cover, Black	38.05
3013 01751	Cover, White	38.05
3013 01771	Cover, Red	38.05
3013 21051	SS Swivel Adapter.	40.65
3013 10201	Brass Swivel Adapter	36.85

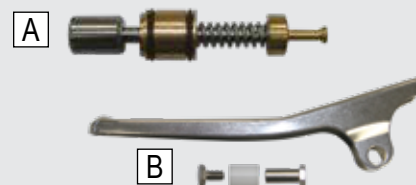

NOTE: These nozzles connect directly to garden hose threads with no adapter needed OR add a swivel adapter (sold separately) to extend hose life and prevent kinking. See ordering information above.

NP1 Sprayer Nozzle

Ergonomic design for easy use, weighing only 1.6 pounds.

- Constructed from stainless steel for durability with a reinforced nylon cover.
- Featuring a trigger controlled variable spray pattern that is ideal for any wash-down application.
- 150 psi, up to 200 °F, flow rate: 8.9 gpm at 100 psi.

SANI-LAV
COLUMBIA
PRODUCTS



INCLUDED: Stainless steel swivel hose adapter 3/4-inch GHT, 3/4-inch hose barb.

ITEM NO.	PRODUCT	EACH
3013 01991	NP1 Sprayer Nozzle, Orange	\$194.35

HydroPro Nozzle

Ergonomically designed handle.

- Easy-to-pull trigger adjusts and locks-in spraying pattern in one smooth movement. No pressure maintenance needed on trigger.
- 100% stainless steel housing with replaceable nylon outer cover stands up to abrasion and impact.
- Rated at 150 psi, +180 °F, flow rate: 7 gpm.



1/2-inch Female NPT inlet.

Strahman

MADE IN USA



INCLUDED: 3/4-inch Swivel Barb!



Attach to standard garden hose with stainless steel hose clamp, sold separately.

Item# 3095 0553 ▶ SEE PAGE 151

ITEM NO.	PRODUCT	EACH
3047 5374	HydroPro Nozzle w/Black Cover	\$384.32
3095 0553	Stainless Steel Hose Clamp	2.95

Insulated Hot Water Spray Nozzle

For use with garden hoses.

- Made of durable stainless steel with molded urethane handle.
- Recommended for use with water up to 180 °F (79 °C).
- Handle remains cool during operation.
- Water flow rate thru nozzle is 4 gpm at 40 psi.

ADAPTER INCLUDED! Ready to connect to standard male GHT.



INCLUDES 15° V-Jet 1/4-inch nozzle tip. Order 25° nozzle tip separately.

1/4 turn-off valve minimizes hand fatigue.

ITEM NO.	PRODUCT	EACH
2900 4014	Insulated Spray Nozzle, Includes 15° Nozzle Tip	\$103.10
2900 15601	Replacement 15° Nozzle Tip	15.40
2900 25501	Optional 25° Nozzle Tip	29.65

Hose Adapters and Accessories

Swivel adapters allow the nozzle to rotate separately from the hose. Swivel adapters also prevent hoses from getting twisted and tangled.

GHT	Garden Hose Thread
NPT	National Pipe Thread
FPT	Female Pipe Thread
MPT	Male Pipe Thread
MNPT	Male National Pipe Thread

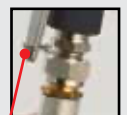

All adapters include a trigger lock.



Need help finding the right adapter or hose accessory?
CALL FOR MORE INFORMATION
800-456-5624

Hose Accessory Kit

A multi-hose kit that will solve all connection problems



ITEM NO.	PRODUCT	EACH
3538 5857	Hose Adapter Kit	\$311.25

Rubber Hose Bend Restrictor

Keeps hose cool to the touch and prevents hose damage around couplings.

- Length: 8 inches.
- Fits most 3/4 inch ID hoses.



ITEM NO.	PRODUCT	EACH
3538 3508	Bend Restrictor	\$5.12

Swivel Hose Adapters



ITEM NO.	PRODUCT	SIZE	EACH
3013 10111	A. Brass Swivel Adapter	1/2" Male NPT x 3/4" Female GHT	\$25.35
3013 00111	B. Stainless Steel Swivel Adapter	1/2" Male NPT x 3/4" Female GHT	31.15
3013 00171	C. Brass Swivel Adapter	3/4" Male NPT x 3/4" Female GHT	26.55
3013 21031	D. Stainless Steel Swivel Adapter	3/4" Male NPT x 3/4" Female GHT	35.93
3013 10121	E. Junior Swivel Adapter, Brass	3/8" Male NPT x 3/4" Female GHT	24.25
3013 01641	Junior Swivel Adapter, Stainless	3/8" Male NPT x 3/4" Female GHT	35.83

NOTE: Adapter E is for use with the Watersaver Junior Nozzle. > SEE PAGE 146

Swivel Hose Barb Adapters



ITEM NO.	PRODUCT	SIZE	EACH
3013 10221	A. Stainless Steel Swivel Hose Barb Adapter	1/2" NPT x 5/8" Hose Barb	\$44.17
3013 1122	B. Brass Swivel Hose Barb Adapter	1/2" NPT x 5/8" Hose Barb	31.31
3013 00151	C. Stainless Steel Swivel Hose Barb Adapter	1/2" NPT x 3/4" Hose Barb	34.82
3013 10151	D. Brass Swivel Hose Barb Adapter	1/2" NPT x 3/4" Hose Barb	27.89
3013 10211	E. Brass Swivel Hose Barb Adapter	1/2" NPT x 1/2" Hose Barb	35.75
3013 21051	F. Stainless Steel Swivel Hose Barb Adapter	3/4" GHT x 3/4" Hose Barb	40.65
3013 10201	G. Brass Swivel Hose Barb Adapter	3/4" GHT x 3/4" Hose Barb	36.85
3013 00221	H. Stainless Steel Swivel Hose Barb Adapter	1/2" MNPT x 1/2" Hose Barb	42.96

On/Off Flow Control Valve

• 3/4-inch male GHT x 3/4-inch female GHT.

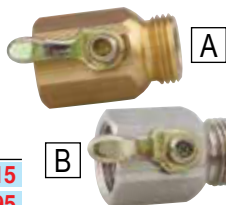

ITEM NO.	PRODUCT	EACH
3013 10161	A. Brass Valve	\$31.15
3013 21021	B. Stainless Steel Valve	73.95

Repair Couplers

• Male GHT x female GHT, 3/4-inch hose barb.



ITEM NO.	PRODUCT	EACH
3538 3122	Brass Coupler	\$21.84

Quick Connect Set

• 3/4-inch male GHT x 3/4-inch female GHT.

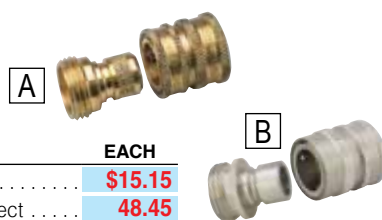

ITEM NO.	PRODUCT	EACH
3538 6361	A. Brass Connect	\$15.15
3013 21041	B. Stainless Steel Connect	48.45

Non-Swivel Hose Adapters

Brass

3/4-inch female GHT x 1/2-inch Male NPT



ITEM NO.	SIZE	EACH
3013 10131	Brass Adapter	\$26.55

Stainless Steel

3/4" Female GHT x 1/2" Male NPT



ITEM NO.	SIZE	EACH
3013 01511	Stainless Steel Adapter	\$32.43

Brass Hose Barb

1/2-inch NPT x 3/4-inch Hose Barb



ITEM NO.	SIZE	EACH
3013 10141	Brass Barb Adapter	\$25.48

Stainless Steel Hose Barb

1/2-inch MNPT x 3/4-inch Hose Barb



ITEM NO.	SIZE	EACH
3013 01501	SS Barb Adapter	\$38.36

Stainless Steel Hose Clamp

- For use with barb adapters.
- Adjustable 7/16 inch to 1 inch.



ITEM NO.	PRODUCT	EACH
3095 0553	Stainless Steel Hose Clamp	\$2.95

Brass Adaptors

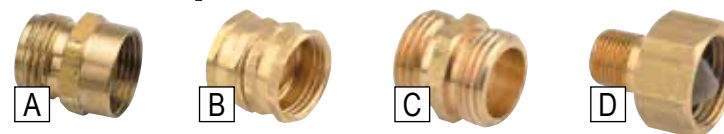

ITEM NO.	PRODUCT	EACH
3538 0006	A. 3/4" Male GHT to Female NPT	\$8.96
3538 0002	3/4" Female GHT to Male NPT	8.96
3538 1003	B. 3/4" Female GHT to Female GHT	12.82
3538 1008	C. 3/4" Male GHT to Male GHT	8.97
3538 0030	D. 3/8" Male NPT to 3/4" Female GHT	10.18

3/4-Inch ID Single-Ply General Purpose Hose

- Recommended for hot water washdown and light-duty applications.
- Red EPDM cover is resistant to weathering, abrasion and oil.
- Withstands temperatures to 180 °F.

Medium-weight single-ply reinforced for hot and cold water mixing.



Coupled with female and male garden hose thread.

ITEM NO.	PRODUCT	EACH
3538 3025	25' Hose	\$83.05
3538 3050	50' Hose	128.65
3538 3075	75' Hose	181.25
3538 0105	100' Hose	244.35

3/4-Inch ID Non-Marking Hot Water Hose

Reinforced with multiple textile spirals.

- Recommended for food plant wash-down requiring hose with sanitary white cover.
- Withstands temperatures up to 212 °F.
- Working pressure 200 psi, max pressure 300 psi.



Heavy-weight four-ply reinforced for high temp conditions.



Coupled with female and male garden hose thread.

ITEM NO.	PRODUCT	EACH
3538 0025	25' Hose	\$128.65
3538 0050	50' Hose	233.85
3538 1375	75' Hose	321.65
3538 0008	100' Hose	708.75

5/8-Inch ID Single-Ply All-Purpose Hose

- Recommended for water temperatures up to 170 °F.
- Red EPDM cover is resistant to weathering, abrasions and oil.

Light-weight single-ply reinforced for hot and cold water mixing.

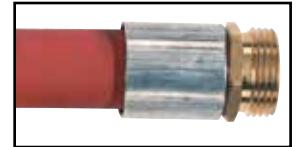

Coupled with female and male garden hose thread.

ITEM NO.	PRODUCT	EACH
3538 9031	25' Hose	\$64.25
3538 04461	50' Hose	109.85

3/4-Inch ID Wrapped Reinforced Yellow Hot Water Washdown Hose

Reinforced with steel wire braid.

- Designed for general clean-up where cold water is mixed with steam.
- Plated steel couplings with two power crimp ferrules.
- Highly-resistant to abrasion, animal fat and vegetable oil.
- Recommended for water temperatures up to 180 °F (93 °C).
- Pre-coupled hose assemblies with garden hose couplings at each end.
- Rated at 1,000 psi.



Hoses are braided steel reinforced.

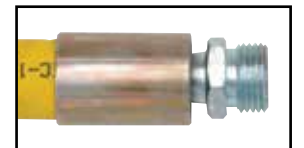

Plated steel coupling is power crimped to last longer.

ITEM NO.	PRODUCT	SIZE	EACH
3538 1025	25' Hose	3/4" ID w/GHT Couplings Each End	\$258.35
3538 1050	50' Hose	3/4" ID w/GHT Couplings Each End	451.35
3538 8475	75' Hose	3/4" ID w/GHT Couplings Each End	643.25
3538 4100	100' Hose	3/4" ID w/GHT Couplings Each End	836.15

**NEED ASSISTANCE?
800-456-5624**



Our experienced customer service representatives are available to answer your questions, find the products you are looking for, check product availability, as well as take your order.



Hot Water Packinghouse Hose

Multiple textile spirals reinforces hose and extends hose life. FREE WITH THIS HOSE — rubber insulators that keep the hose cool to the touch.

- Couplings are securely attached to each end of the hose with no sharp edges and are covered by a heavy-duty reinforcement insulator to prevent failure at the base of the hose and to keep the ends cool to the touch.
- Hose assemblies are pre coupled with garden hose couplings on each end. • Withstands 500 psi.
- Withstands temperatures up to 212 °F. • Highly-resistant to cuts and abrasions.
- Available in 3/4 inch ID and 1/2 inch ID.

FREE rubber insulator keeps hose cool to the touch.



Double braided nylon reinforced.



ITEM NO.	LENGTH	SIZE	EACH
3538 7108	25'	1/2" ID w/GHT Couplings Each End	\$155.45
3538 7109	50'	1/2" ID w/GHT Couplings Each End	258.35
3538 7100	100'	1/2" ID w/GHT Couplings Each End	451.35
3538 2025	25'	3/4" ID w/GHT Couplings Each End	180.05
3538 2050	50'	3/4" ID w/GHT Couplings Each End	302.85
3538 2075	75'	3/4" ID w/GHT Couplings Each End	451.35
3538 4085	85'	3/4" ID w/GHT Couplings Each End	451.35
3538 0100	100'	3/4" ID w/GHT Couplings Each End	688.85

Safety Air Nozzle and Hose

- Air nozzle (blow gun) constructed from heavy-duty plastic for greater durability.
- Nozzle has 1/4-inch NPT standard inlet (fits air hoses listed below).
- Red 300 psi air hose has male connections at each end.
- Choose from either 1/4-inch NPT or 3/8-inch NPT in lengths of 25 feet or 50 feet.



ITEM NO.	LENGTH	SIZE	EACH
3538 0004	A. Safety Air Nozzle	1/4" NPT Female Inlet	\$39.77
3538 6600	B. Air Chuck	1/4" Female Inlet	5.12
3538 2526	C. Air Hose	25' Length x 1/4" NPT Male End	38.55
3538 2525	Air Hose	50' Length x 1/4" NPT Male End	71.25
3538 3725	Air Hose	25' Length x 3/8" NPT Male End	37.35
3538 2527	Air Hose	50' Length x 3/8" NPT Male End	64.25
3538 3003	D. Female Quick Coupler	1/4" Female End	10.18
3538 3203	Female Quick Coupler	1/4" Male End	10.18
3538 3113	E. Male Quick Coupler Plug	1/4" Female End	3.91
3538 3103	Male Quick Coupler Plug	1/4" Male End	2.48

Long John Safety Air Gun

- Air gun blows air to safely clean inaccessible and hard-to-reach areas.
- Efficient nozzle boosts thrust up to 200% over conventional air guns.
- Limits static pressure to less than 30 psi should the tip become blocked.
- Ergonomic pistol-grip handle provides maximum user comfort.
- Body constructed of durable cast aluminum. • Meets OSHA standards.
- Zinc alloy nozzle has a 1/4-inch FNPT inlet. • Air usage: 34 cfm.
- Output thrust: 2 pounds. • Noise level: 107 dB.

ITEM NO.	LENGTH	WEIGHT	EACH
4676 5012	12" Extension	0.8 lb	\$34.05
4676 5018	18" Extension	0.8 lb	36.25
4676 0024	24" Extension	0.9 lb	38.45
4676 00361	36" Extension	1-1/5 lb	41.75
4676 5048	48" Extension	1.4 lb	43.95
4676 90601	60" Extension	1-1/2 lb	51.65
4676 0072	72" Extension	1.7 lb	57.15

Available in 7 different lengths.



Stainless Steel Wall-Mount Hose Holder

- Heavy-duty stainless steel construction. • Easy to clean.
- Suitable for wet or harsh environments.



Hose sold separately.

ITEM NO.	PRODUCT	EACH
2990 00581	Stainless Steel Hose Holder	\$134.85



M5000 Instant Hot Water Mixing Station

Temperature indicating, instant hot water mixing station. Mix steam and cold water safely.

- Automatic shut-off.
- Requires 50 to 80 psi water pressure and 80 to 150 psi steam pressure.
- Dual-range dial thermometer standard.
- Maximum operating temperature 200 °F (93 °C).
- Specify steam pressure: Low (80-95 psi), Med. (96-130 psi) or High (131-150 psi).

NOTE: Hose sold separately.



ITEM NO.	PRODUCT	F.O.B. FACTORY EACH
3047 5000	M5000 and Rack Only.	\$2,960.95
3047 1026	25' Hose Assembly	774.05
3047 0100	Stainless Steel Hose Rack.	209.25

Budget Mixing Station for Hot and Cold Water

Low-cost, maintenance-free hose station with heavy-duty globe.

- Economy unit with 125# globe and check valves and hose rack.

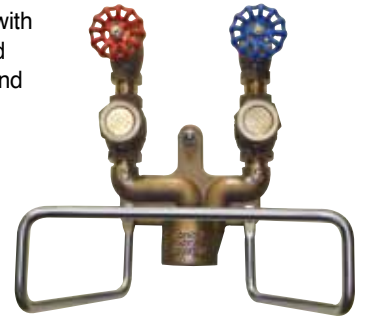

ITEM NO.	PRODUCT	F.O.B. FACTORY EACH
3035 0800	Budget Hose Station, Bronze	\$582.05

Econo-Mix

A low cost solution for hot and cold water mixing.



- Economical solution for mixing hot and cold water.
- Dial thermometer ensures that water temperature is being held at the required set point.
- Rated 200 psi with no minimum water pressure required.
- Removable, stainless steel hose rack can be mounted remotely or as part of the hose station.
- UL approved.



ITEM NO.	PRODUCT	F.O.B. FACTORY EACH
3035 2135	Econo-Mix	\$684.15

SteamMaster 2000

Temperature indicating, instant hot water mixing station. Mix steam and cold water safely.

- Automatic shut-off in event of cold water failure.
- Requires 50 to 80 psi water pressure and 80 to 94 psi steam pressure.
- Dual-range dial thermometer standard.
- Maximum operating temperature 200 °F (93 °C).
- Steam enters the blending chamber via a steam diffuser, yielding quieter operation.



NOTE: Hose and nozzle sold separately.

ITEM NO.	PRODUCT	F.O.B. FACTORY EACH
3566 3221	SteamMaster 2000 Only	\$1,747.00
3566 3222	With 25' Hose and Nozzle	2,219.10

M-1 Hot and Cold Mixing Station

Designed to mix hot and cold water in any desired amount.

- Equipped with a temperature gauge to measure water temperature.
- Maximum pressure: 150 psi
Maximum temperature: 200 °F (90 °C)
- Standard globe valves.
- High-low adjustable flow rate.

▶ SEE PAGES 152-153
Hose Sold Separately



ITEM NO.	PRODUCT	F.O.B. FACTORY EACH
3013 2024	M1 Mixing Station	\$672.45

GunJet® High-Pressure Spray Nozzle

Includes built-in hose swivel and adjustable spray nozzle.



1/4-inch FPT outlet.

- Maximum operating pressure: 4,000 psi.
- Maximum operating temperature: 150 °F.
- Strainer is easily removed for cleaning or screen replacements.
- Ergonomically designed handle is made of long-lasting, high-impact nylon.
- Adjustable spray pattern from solid stream to 80° spray.
- Capacity: 10 gpm.

Bottom trigger pivot reduces operator fatigue.

Built-in inlet swivel connection, 3/8-inch NPT (F) eliminates hose twisting.



Optional 18-inch wand with rubber safety cover.

ITEM NO.	PRODUCT	EACH
3065 03751	Nozzle and Spray Wand Tip	\$319.04
3065 03761	18" Extension Wand	118.97

Rear Inlet High-Pressure Nozzle



- Molded plastic handles feature a textured grip for operator safety and remain cool during washdown, requiring no special gloves or insulating cover.
- Use with water temperatures up to 200 °F (93 °C).
- Wand with adjustable spray nozzle sold separately.
- 3/8-inch FPT inlet and 1/4-inch FPT outlet.
- Water flow rate is 8 gpm at 2,000 psi maximum.



Rear loading inlet.

Lock-out.

Optional 36-inch spray wand.

NOTE: Additional tips sold separately. Use any type "B" tips. SEE BELOW.

ITEM NO.	PRODUCT	EACH
3026 0515	Rear-Loading High-Pressure Nozzle	\$35.95
2990 11321	36" Wand and Adjustable Spray Nozzle	77.20

GunJet® High-Pressure Nozzle

- Trigger lock allows continuous spraying.
- Heavy-duty brass inlet body and tip retainer.
- Nylon valve seat and stainless stem.
- 1/2-inch FPT inlet and 1/8-inch FPT outlet.
- Recommended for water temperatures up to 200 °F (93 °C).
- Water flow rate is 15 gpm at 800 psi maximum.
- Order nozzle tip separately.

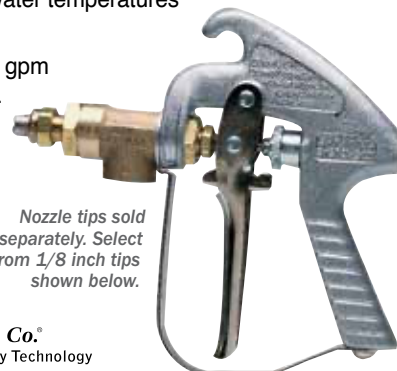

Nozzle tips sold separately. Select from 1/8 inch tips shown below.



Optional 18-inch extension wand.

ITEM NO.	PRODUCT	EACH
3065 03671	Pressure Gun Only	\$204.08
3065 58281	18" Extension Wand	123.34

GunJet® High-Pressure Nozzle Tips

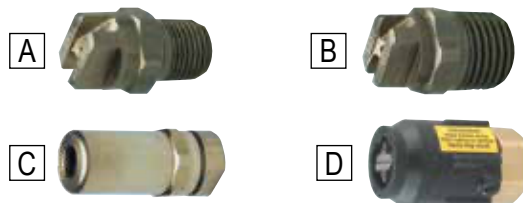

ITEM NO.	PRODUCT	EACH
3065 00231	A. 15°, 1/8" MPT Nozzle Tip	\$12.32
3065 00241	25°, 1/8" Nozzle Tip	12.31
3065 00251	40°, 1/8" Nozzle Tip	12.31
3065 15041	B. 15°, 1/4" MPT Nozzle Tip	12.30
3065 98491	25°, 1/4" Nozzle Tip	12.30
3065 98501	40°, 1/4" Nozzle Tip	12.30
3065 26681	C. 15°, 1/4" FPT Oscillating Spray Tip, Brass	120.46
3065 26671	D. 80°, 1/4" FPT Adjustable Nozzle	167.53

High-Pressure Accessories

ITEM NO.	PRODUCT	EACH
3538 1038	A. 3/8" FPT Brass Swivel	\$16.67
3538 6045	1/4" FPT Brass Swivel	14.14
2900 2114	B. 1/4" FPT to Female GHT Ball Valve	41.05
3538 0038	C. 3/8" FPT Straight Quick Disconnect Adapter	16.67
3538 04381	D. 3/8" FPT Male End Plug Valve	7.65
3538 81321	E. 1/4" Brass Close Nipple	2.48
3538 81331	3/8" Brass Close Nipple	2.48
3538 0003	F. 3/8" FPT Straight Quick Disconnect Adapter w/Auto Shut Off	54.95
3538 71971	G. 3/8" FPT Male End Plug Valve w/Auto Shut-Off	18.95



Use with (C) quick disconnect adapter.

Use with (F) straight quick disconnect adapter with auto shut-off.

Cam Spray Indoor*/Outdoor Cold Water Pressure Washers



A. X Cart Cold Water Pressure Washer

High-pressure dependability and portability.

- Maximum temperature: 160 °F.
- Industrial coated steel frame with 10-inch tires.
- Fully enclosed 7.5 hp motor rated at 3,000 psi; 4 gpm.
- Triplex plunger pump, ceramic plungers and stainless steel valves.
- Low pressure chemical injection for application of concentrate liquid detergents and is activated by using the low pressure detergent nozzle.
- 35-foot power cord with ground fault circuit interrupter.
- 37 inches x 23-1/2 inches x 36 inches.
- Shipping weight: 265 pounds.
- 50-foot pressure hose.



B. Hand Carry Cold Water Pressure Washer

High-pressure dependability and easy maintenance.

- Fully enclosed 2.0 hp motor rated at 1,450 psi; 2 gpm.
- 2-piece gun/wand with variable pattern tip, 0-60° spray pattern.
- Triplex plunger pump, ceramic plungers and stainless steel valves.
- Variable pressure adjustment, low-pressure chemical injection for application of concentrated liquid detergents and is activated by a hi-low pressure adjustable nozzle on the trigger gun.
- 35-foot power cord with ground fault circuit interrupter.
- Maximum temperature: 160 °F.
- 18 inches x 12 inches x 11 inches.
- Shipping weight: 68 pounds.
- 25-foot pressure hose.



F.O.B. FACTORY

ITEM NO.	PRODUCT	MFR. NO.	EACH
3437 3000	A. 3,000 psi, Portable	3000XAR	\$7,612.35
3437 1501	B. 1,450 psi, Hand-Held	1500ADE	1,901.30
3437 2078	Replacement Hose for 1500ADE, 25'		116.56



NOTE: We recommend use with our Challenge General Purpose Cleaner.

▶ SEE PAGE 140

▶ 4 BOTTLES PER CASE.

ITEM NO.	PRODUCT	CASE
6129 6703	1 Gallon	\$109.15

Non-Marking High-Pressure Hose

- Reinforced with wire-braid.
- Rated at 3,000 psi to temperatures up to 170 °F.
- 3/8-inch NPT connectors on 3/8-inch ID hose.
- One swivel and one straight fitting.
- Bend restrictors at each end.

Available with 1/2-inch or 3/8-inch NPT male connectors on both ends.



ITEM NO.	PRODUCT	INSIDE DIMENSIONS	EACH
3538 20821	75' Hose	1/2" ID	\$385.95
3538 80761	25' Hose	3/8" ID	115.75
3538 98371	50' Hose	3/8" ID	163.75
3538 0015	75' Hose	3/8" ID	325.05



FREE GROUND SHIPPING
when you place an order for \$500
or more from
THIS BUYERS GUIDE!

*FREE SHIPPING does NOT include UPS Next Day Air, UPS 2nd Day or UPS 3rd Day Select. Certain items may not qualify. This offer is good only on orders shipped UPS Ground in the 48 contiguous states. Based on dimensional weight, we will determine the most efficient means of shipment, either UPS or LTL. Products may ship by truckline.

5-Liter Pump-Up Foam Unit

- Comfortable grip handle with trigger for quick on/off control.
- Ability to switch between short and long wand assembly.
- Natural color tank for easy visibility of product levels.
- Product level fill markings in gallons and liters.
- Viton pump seals for chemical compatibility.
- Polypropylene tank and pump head.
- Maximum portability for small jobs.
- Compact unit with manual pump.
- Pressure relief valve for safety.



F.O.B. FACTORY

ITEM NO.	PRODUCT	EACH
0846 00451	5-Liter Pump-Up Foamer	\$333.65

Portable Foam Units

Choose from 10- or 20-gallon units.

- Stainless steel wand assembly and fluid fittings.
- Quick change pump — no tools required.
- Hinge plate assembly for easy access.
- Inline strainer for debris protection.
- Hinged fill cap. • Large drain in front of tank.
- Santoprene diaphragm pump.
- 10-gallon unit includes 20 feet of 1/2-inch discharge foam hose.
- 20-gallon unit includes 30 feet of 3/4-inch discharge foam hose.



F.O.B. FACTORY

ITEM NO.	PRODUCT	DIMENSIONS	SHIPPING WT.	EACH
0846 2010	10-Gallon Unit	44" x 17" x 19"	43 lb.	\$1,778.75
0846 2020	20-Gallon Unit	47" x 22" x 17"	56 lb.	1,889.95

1.5-Liter Pump-Up Foam Unit

- View stripe for easy visibility of product level.
- Comfortable grip handle with trigger for quick on/off control.
- Viton pump seals for chemical compatibility.
- Polypropylene tank and pump head. • Maximum portability for small jobs.
- Stability base with gripping notches. • Compact unit with manual pump.
- Nozzle with 110° fan tip. • Pressure relief valve for safety.



ITEM NO.	PRODUCT	EACH
0846 00391	1.5 Liter Pump-Up Foamer	\$106.95

3-Gallon Pump-Up Foamer

A portable foam applicator for applying foaming chemicals to any surface

- Creates rich, clinging foam that adheres to surfaces longer to maximize chemical effectiveness.
- Projects the ideal amount of foam for small or large jobs requiring maximum portability.
- Fill the tank with ready-to-use chemical solution, pump it up and foam.
- Use the "quick change" valve to pressurize with an air compressor instead of pumping (must disconnect airline during operation).
- Heavy-duty, easy-grip trigger gun with locking latch.
- Wide fan pattern nozzle for fast application.
- Stainless steel nozzle, 1/4 inch.
- Requirements: Ready-to-use chemical solution. Temperature up to 120 °F. Accepts compressed air up to 45 PSI.



Includes:

- Heavy-Duty 3-Gallon Polyethylene Tank with UV Inhibitor
- Tank Stabilizing Base
- Heavy-Duty Manual Pump
- Viton/Nitrile Seals and O-Rings
- Tube of Silicone Grease
- Pressure Relief Valve
- Compressed Air "Quick Charge" Valve
- Machined Foamer Body
- 6-foot Discharge Hose
- Heavy-Duty Trigger Gun with Viton Internal Seals
- Polypropylene 10" Wand and Stainless Steel Fan Nozzle

ITEM NO.	PRODUCT	SHIPPING WT.	EACH
7981 51131	3-Gallon Pump-Up Foamer	10 lb.	\$251.28

The Ultimate Industrial Foamer/Sanitizer Solution

Designed for cleaning, degreasing or disinfecting. Water pressure operated.

- Rated at 180 °F (82 °C).
- Maximum pressure: 100 psi.
- Washers and o-rings are made from high temperature resistant Viton material.



Foamer Unit

Foamer Kit Includes:

- Foamer Lid — for items that need more dwell time.
- Standard-Duty Nozzle
- 96-Ounce Container
- Quick-Disconnect Coupler
- Internal Lafferty Air Injector
- Colored Flow-Rate Nozzles

Includes multiple colored nozzles which determine flow rate of foamer.



Sanitizer Unit

Sanitizer Kit Includes:

- Sanitizer Lid — for a liquid sanitizer or a rinse.
- Standard-Duty Nozzle
- 96-Ounce Container
- Quick-Disconnect Coupler
- Colored Flow-Rate Nozzles

ITEM NO.	PRODUCT	EACH
3013 30031	Foamer Unit	\$98.15

ITEM NO.	PRODUCT	EACH
3013 10181	Sanitizer Unit	\$98.15

Foamer and Sanitizer Unit Accessories

A. Ergonomic Mid-Size, Insulated Hot Water Spray Nozzles

- Designed for use in the food service and processing industry.
- Brass main body. • Quality built with stainless steel and brass parts.
- Insulated rubber cover with yellow direction arrows.
- Maximum working pressure: 150 psi. • Rated 200 °F (93 °C).
- Variable spray pattern. • 3/4-inch female GHT inlet. • Weight: 1.7 pounds.

SEE FACING PAGE.
For Recommended Chemicals



B. 48-Ounce Container

- The ideal size for smaller jobs.

C. Foamer Unit Replacement Lid

D. Sanitizer Unit Replacement Lid

E. Quick-Disconnect Coupler

- Quickly connects nozzle to foamer or sanitizer top.

F. On/Off Flow Control Valve

G. Swivel Adapters

- Extends hose life by preventing kinks.



Outlet cover can be unscrewed to attach to coupler SHOWN BELOW.



Use optional adapters to attach garden hose to nozzle.



ITEM NO.	PRODUCT	EACH
3013 30011	A. Ergonomic Mid-Size, Insulated Hot Water Spray Nozzle	\$84.25
3013 02481	B. 48-oz. Container	34.65
3013 60021	C. Foamer Unit Replacement Lid	52.25
3013 00701	D. Sanitizer Unit Replacement Lid	45.75
3013 50021	E. Quick-Disconnect Coupler	26.58
3013 10161	F. On/Off Flow Control Valve (Male GHT to Female GHT)	31.15
3013 00171	G. Brass Swivel Adapter, 3/4" GHT, 3/4" GHT	26.55
3013 21031	Stainless Steel Swivel Adapter, 3/4" GHT, 3/4" GHT	35.93

Bunzl C-R-S Cleaning System

Bunzl's Clean-Rinse-Sanitize System makes production area cleaning fast and easy!



Place cleaning/foaming agent (with metering tip) in one container and sanitizer (with metering tip) in the second container – then disinfect with

THREE EASY STEPS!

- 1. Clean:** Attach nozzle to foaming unit with quick disconnect coupler. Then spray foam on area to be cleaned.
- 2. Rinse:** Disconnect nozzle and rinse foam away using spray nozzle.
- 3. Sanitize:** Attach nozzle to sanitizing unit with quick disconnect coupler. Then spray sanitizing solution on area to be sanitized.



C-R-S System Includes:

- Foaming Unit Lid
- Sanitizing Unit Lid
- (2) 96-Ounce Containers
- Standard-Duty Orange Nozzle
- Quick Disconnect Coupler
- (2) Chemical Dilution Metering Tips



Scan this QR code with your mobile device to see how easy it is to use the C-R-S Cleaning System!



1. CLEAN/FOAM

2. RINSE

3. SANITIZE

ITEM NO.	PRODUCT
3013 29601	C-R-S Bundle

KIT
\$122.45

Recommended Chemicals

Roubaix™/MC Multi-Purpose Foam Cleaner

- Spray or foam onto surfaces to degrease and clean tough soils.
- Safe on most surfaces.
- Anionic liquid for general purpose medium to heavy-duty applications.
- pH 11.85



ITEM NO.	PRODUCT	EACH
1520 1455	5-Gallon Pail	\$136.87
1520 1412	55-Gallon Drum	717.65

Divosan® Spectrum Sanitizer

Concentrated neutral quaternary sanitizer.

- Sanitizes food contact and other hard nonporous surfaces and equipment.
- Dilution rate: 1 ounce per 4 gallons of water.
- An effective bactericide, virucide and fungicide.
- Phosphate-free. • Concentrate.
- pH 7

▶ 4 GALLONS PER CASE.



ITEM NO.	PRODUCT	CASE
1520 6561	Divosan® Spectrum, 1 Gallon	\$94.95

ProTwin Cleaning and Sanitizing Station

The ProTwin automatically mixes and dispenses concentrate chemicals for surface cleaning applications.

- Foam, rinse and sanitize with one ProTwin unit – up to 140 °F (60 °C) tolerance.
- Separate selectable chemical positions eliminate risk of chemical crossover.
- Insures accurate and proportionate dosing.
- Intuitive ergonomic design for user friendly options.
- A single spray gun is used all ProTwin applications.
- Adjustable spray pattern



ProTwin System Includes:

- ProTwin Station
- Foam Wand
- Blue Spray Gun w/Quick Connect
- 25-Foot Red Hose
- 6-Foot Heavy-Duty Goodyear® Hose
- Colored Flow-Rate Nozzles

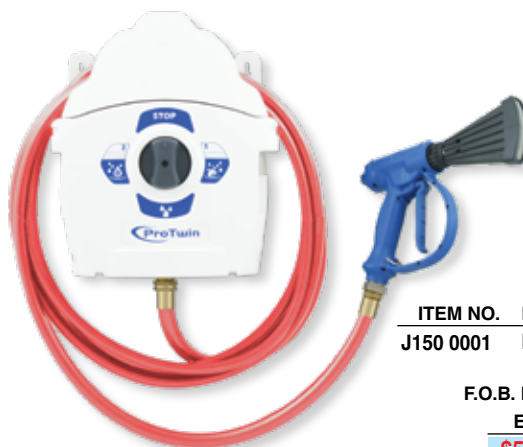

ITEM NO.	PRODUCT
J150 0001	ProTwin Station

F.O.B. FACTORY
EACH
\$528.93

PERFORMANCE	PRESSURE	DILUTION RATE	FLOW RATE
Maximum	85 psi	6.5:1	(Rinse) 4.2 gpm
Minimum	22 psi	1429:1	(Prod) 2.4 gpm

Recommended Chemicals

Roubaix™/MC Multi-Purpose Foam Cleaner

- Spray or foam onto surfaces to degrease and clean tough soils.
- Safe on most surfaces.
- Anionic liquid for general purpose medium to heavy-duty applications.
- pH 11.85



ITEM NO.	PRODUCT	EACH
1520 1455	5-Gallon Pail	\$136.87
1520 1412	55-Gallon Drum	717.65

Divosan® Spectrum Sanitizer

Concentrated neutral quaternary sanitizer.

- Sanitizes food contact and other hard nonporous surfaces and equipment.
- Dilution rate: 1 ounce per 4 gallons of water.
- An effective bactericide, virucide and fungicide.
- Phosphate-free. • Concentrate.
- pH 7



► 4 GALLONS PER CASE.

ITEM NO.	PRODUCT	CASE
1520 6561	Divosan® Spectrum, 1 Gallon	\$94.95

Timed Uni-Body™ Entryway Foam Sanitizer

Turn anti-bacterial chemicals into rich foam that clings to surfaces and fills in gaps and cracks to create a barrier to contamination. Great for HACCP use!

- Manual override switch provides instant foam when needed.
- Requires compressed air and 35-125 psi water.
- For doorways up to 3-4 feet wide.
- Adjustable foam and delay cycle timers.
- Requirements/Specifications:
Compressed Air: Up to 3 cfm.
Water Pressure: 35-125 psi.
Water Temperature: Up to 160 °F.
Water Flow Rate: 1.34 gpm @40 psi.
Dilution Ratio: 306:1 to 6:1 @ 40 psi.
Discharge Hose/Plumbing: 3/4-inch ID
Length: 10 to 50 feet.
Electrical: 120 VAC.

► SEE PAGES 133-135
For More Cleaners and Sanitizers

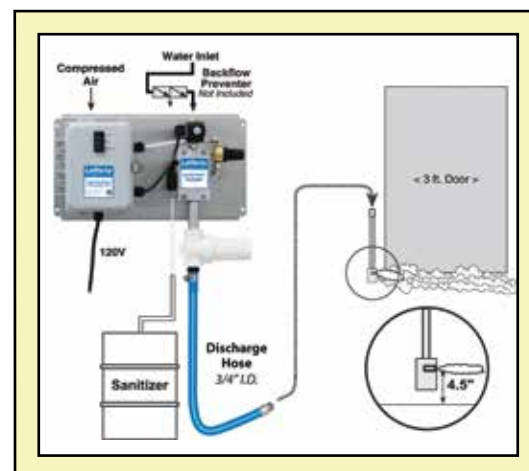

ITEM NO.	PRODUCT	EACH
7981 0001	Entryway Foam Sanitizer	CALL

PURELL® E3 Rated Sanitizing Wipes

Sanitizes hands while removing light soils and dirt.

- Kills 99.99% of most common germs that may cause illness.
- Non-linting, durable, textured wipe for superior cleaning.
- Canister allows one wipe to be removed at a time.
- Available in two sizes: 100 and 270 wipe canisters.
- Formulated to dry quickly.



ITEM NO.	PRODUCT	QTY.	CASE
3540 9111	A. 100-Wipe Canister	12/Case	\$86.41
3540 9116	B. 270-Wipe Canister	6/Case	91.47

SCRUBS® Hand Sanitizer Wipes

A highly effective skin sanitizing formula and an abrasive, non-scratching towel combine for a one-step sanitizing system.

- Replaces alcohol gels, which do not remove contaminants.
- Helps reduce the risk of infection and disease.
- Kills 99.9% of germs including MRSA.
- Prevents cross-contamination.
- 6 inches x 8 inches.
- Dissolves bio-film.



▶ 6 CANISTERS PER CASE.

ITEM NO.	PRODUCT	EACH
3112 09855	85-Wipe Canister	\$9.95

SHOP 24/7 bunzlpd.com

Where you can find out what's on sale, find updated product information, reviews and pricing.

STAY CONNECTED WITH US:



Need Help? Chat With Us Online!



GOJO® Scrubbing Towels

Formulated to lift heavy dirt and grime from skin pores without dryness or irritation.

- Dual textured with a scrubbing side for removing tough soils and a smooth side for quick dirt absorption.
- Pre-moistened with a GOJO® heavy-duty cleaning solution.
- Contains skin conditioners to help prevent dryness and irritation.
- For use anywhere heavy duty cleaning is required; no water needed.
- 72-count bucket features SimPul™ Nozzle Technology, which virtually eliminates roping, providing one towel every time.



ITEM NO.	PRODUCT	EACH
3540 63965	72-Count Bucket	\$16.91
3540 63985	170-Count Bucket (2 Pack)	66.29

NSF "E" CATEGORY CODES

Good Manufacturing Practices dictate that these products are to be located a sufficient distance from the processing line and placed in satisfactory dispensers to preclude accidental food product contamination.

CODE	DESCRIPTION	REQUIREMENTS
E1	Handwashing Products	<ul style="list-style-type: none"> Approved for use throughout the plant. After use, hands must be thoroughly rinsed with potable water. Hands need not be washed prior to using. Use with PURELL® E3 Rated Instant Hand Sanitizer prior to handling food.
E2	One-Step Handwashing and Sanitizing Products	<ul style="list-style-type: none"> Approved for use throughout the plant. Approved for hand/food contact after handwashing. Hands need not be washed prior to using. After use, hands must be thoroughly rinsed with potable water.
E3	Hand Sanitizing Products	<ul style="list-style-type: none"> Approved for use throughout the plant. Approved for hand/food contact after handwashing. Hands must be washed and thoroughly rinsed prior to using. Hands need not be rinsed with potable water following use. For use in combination with GOJO® E2 Foam Handwash.
E4	Hand Creams, Lotions and Cleansers	<ul style="list-style-type: none"> Use in federally inspected meat and poultry plants is limited to: toilets, dressing rooms and non-processing areas. Employees who process inspected meat, fish and poultry products should use only when leaving the plant.

Alpet E3 Plus Waterless Hand Sanitizer

Reduces bacteria on hands or gloves when used as directed. Meets all current FDA requirements for hand sanitizers in food handling environments.

- Approved E3 alcohol rinse sanitizer allows worker to directly touch meat after use.
- Formulated with emollients to soften and improve skin condition.
- Kills 99.9999% (LOG6) of 26 tested pathogens in 15 seconds (including Staphylococcus Aureus, Listeria monocytogenes, Escherichia coli, E. coli O157:H7 and more).
- Meets HACCP guidelines for consistent measurable results.
- Reduces the risk of cross contamination. • Kosher certified.



ATOMIZATION - The CDC says that 40% to 50% of pathogens on the hands are on the nails and cuticles, where most hand washing misses. Atomized sanitizers saturate the nails and cuticles, with a consistent amount of sanitizer each time it is used.



NOTE: Spray pump, bottle and atomizer pump sold separately.



Scan this QR code with your mobile device to watch a video about Alpet E3 Sanitizer usage and benefits.



ITEM NO.	PRODUCT	EACH
0031 0112	1-Liter Bottle (6/Case)	\$95.33
0031 9008	Atomizer Spray Pump for 1-Liter Bottle	7.62
0031 90141	Refill, 1 Gallon	38.16
E542 10701	Atomizer Spray Pump for 1-Gallon Bottle	5.75

GOJO® Green Certified Foam Hand Cleaner

Be environmentally responsible without sacrificing product performance.

- A mild, biodegradable foam soap formula certified by Green Seal™ and EcoLogo™ to meet their joint standard (GS-41/CCD-104) for hand cleaners and hand soaps.



▶ 6 PER CASE.

ITEM NO.	PRODUCT	EACH
3540 15021	7.5 fl. oz.	\$6.23

Purell® Advanced Hand Sanitizer Gel



- Kills 99.99% of most common germs that may cause illness.
- Leaves no residual fragrance or harmful residue.
- Use to supplement routine handwashing.
- No water or towels needed.
- Non-toxic and dye-free.

NOTE: This product is NOT E3 rated.

▶ TWELVE, 12-OUNCE BOTTLES PER CASE.



ITEM NO.	PRODUCT	CASE
3540 0206	12-oz. Bottle w/Pump	\$80.05





Purell® Advanced E3 Rated Instant Hand Sanitizer

No rinse hand sanitizer for use in between hand washes or in conjunction with E1 or E2 product.



- Effective against common spoilage and food borne pathogens.
- Kills 99.99% of most common germs that may cause illness.
- Meets guidelines for use in food processing facilities and listed with NSF International.
- Leaves no residual fragrance or harmful residue.

Dispensers

▶ 6 PER CASE.

ITEM NO.	PRODUCT	EACH
3540 20061	A. Purell® NXT® Space Saver™ (Dispenser for 3540 2163)	\$28.86
3540 21061	B. Purell® FMX (Dispenser for 3540 5193)	21.95



Hand Sanitizers

ITEM NO.	PRODUCT	EACH
3540 2163	C. Hand Sanitizer Gel, 1,000 mL Refills (8/Case)	\$129.87
3540 1162	D. Hand Sanitizer Foam, 1,200 mL Refills (4/Case)	142.35



Purell® Advanced E3-Rated Instant Hand Sanitizer and TFX™ Touch Free Dispenser

Use as a no-rinse adjunct to handwashing.



- Effective against germs that may cause illness.
- Meets guidelines for use in USDA and US federally regulated food processing facilities.
- Dispenser is touch-free and automatically dispenses the correct amount of sanitizer.

ITEM NO.	PRODUCT	EACH
3540 20021	A. TFX Touch-Free Dispenser	\$105.45
3540 9302	B. E3 Hand Sanitizer Foam, 1,200 mL (2/Case)	110.68
3540 2003	C. E3 Hand Sanitizer Gel, 1,200 mL (4/Case)	110.57



SIGN UP FOR OUR eDEALS

Get exclusive offers not found anywhere else!

eDEAL SIGN-UP FORM AVAILABLE ON OUR WEBSITE.

www.bunzlpd.com

Manual Foam Soap Dispenser, 2,000 mL

- Unlike pump soaps, one push delivers a generous portion of E2 foam; eliminating waste and allowing almost 3,000 hand washes per refill with 2,000 mL system.
- Dispenser is easy to install and 100% moisture tolerant for washdowns.
- Ideal for high-traffic areas.



▶ 6 PER CASE.

ITEM NO.	PRODUCT	EACH
7500 03221	Soap Dispenser, Gray/White	\$21.25

E2 Foam Sanitizing Soap, 2,000 mL

A one-step foaming hand wash and sanitizing soap.

- E2 formula has a rich, smooth lather that effectively removes animal fats and oils and rinses very quickly.
- Meets USDA regulated food processing environment requirements.
- Non-irritating, fragrance-free.
- Does not contain triclosan.



**NOTE: Fits 2,000 mL dispensers.
Sold separately. SEE ABOVE**

▶ 2 PER CASE.

ITEM NO.	PRODUCT	CASE
7500 4247	E2 Foaming Soap, 2,000 mL	\$98.05

Antimicrobial Foaming White Hand Soap, 2,000 mL

**NOTE: Fits 2,000 mL dispensers.
Sold separately. SEE ABOVE**



▶ 2 PER CASE.

ITEM NO.	PRODUCT	CASE
7500 4240	2,000 mL Hand Soap	\$76.95

Foaming Hand, Hair and Body Wash, 2,000 mL

- Ideal for high-traffic areas.
- Sealed body is sanitary and helps lock out germs.
- Spa-quality body wash and hair shampoo has a cucumber melon fragrance.
- Dispenser is easy to install and 100% moisture tolerant for washdowns.



**NOTE: Fits 2,000 mL dispensers.
Sold separately. SEE ABOVE**

▶ 2 PER CASE.

ITEM NO.	PRODUCT	CASE
7500 4241	2,000 mL Hand, Hair and Body Wash.	\$76.95

FMX-20™ Manual Foam Soap Dispenser, 2,000 mL

- Unlike pump soaps, one push delivers a generous portion of E2 foam; eliminating waste and allowing almost 3,000 hand washes per refill with 2,000 mL system.
- Dispenser is easy to install and 100% moisture tolerant for wash downs.
- Ideal for high-traffic areas.
- E2 soap removes fats, oils and other food processing soils.



▶ 6 PER CASE.

ITEM NO.	PRODUCT	EACH
3540 70091	GOJO® 2,000 mL Soap Dispenser, Gray/White	\$24.65

▶ 2 PER CASE.

ITEM NO.	PRODUCT	CASE
3540 0169	GOJO® E2 Foaming Soap, 2,000 mL	\$87.55

GOJO® HAND MEDIC® ADX™ Professional Skin Conditioner

Helps maintain the skin's natural protective barrier with no greasy feel.

- Use before work, after handwashing and at night.
- Dermatologist-tested.
- Silicone- and fragrance-free.
- Meets E4 guidelines.



▶ 6 PER CASE.

ITEM NO.	PRODUCT	EACH
3540 87821	700 mL Dispenser	\$24.65

▶ 4 PER CASE.

ITEM NO.	PRODUCT	CASE
3540 8745	685 mL Refills	\$98.05

GOJO® Manual Dispensers

- Heavy-duty bag-in-box dispenser with large sight window shows the product inside and makes it easy to see when it's time to refill.
- One hand, push-style operation.
- Portion control helps reduce waste.
- Compatible with GOJO® brand refills.



ITEM NO.	PRODUCT	EACH
3540 0021	A. GOJO® Pro™ TDX™ 2,000 mL Dispenser	\$39.65
3540 0004	B. GOJO® Pro™ TDX™ 5,000 mL Dispenser	50.42

GOJO® E2 Sanitizing Lotion Soap

Handwashing and sanitizing compound.

- Can be used by plant personnel before returning to the processing line.
- One step hand washing and sanitizing. Eliminates the need to use a sanitizing compound after washing.
- Refills are recyclable.
- Does not contain triclosan.



NOTE: Fits 2,000 mL dispensers. Sold separately. SEE ABOVE

ITEM NO.	PRODUCT	QTY	CASE
3540 1070	2,000 mL E2 Lotion Soap	4 Boxes/Case	\$127.65

GOJO® MULTI GREEN® Hand Cleaner

- Multi-purpose hand cleaner removes light to medium industrial soils and dirt.
- Contains a natural, citrus solvent cleaner and non-abrading scrubbing particles.
- SANITARY SEALED™ refill helps prevent contamination.

ITEM NO.	PRODUCT	CASE
3540 0018	2,000 mL Multi-Green (4/case)	\$110.79
3540 0042	5,000 mL Multi-Green (2/case)	173.93



NOTE: Fits 2,000 mL or 5,000 mL dispensers. Sold separately. SEE ABOVE

Bag-In-Box Dispenser, 800 mL

- Heavy-duty bag-in-box dispenser with display window shows the product inside and makes it easy to see when it's time to refill.
- ADA-compliant, one hand, push operation reinforces mounting with each use.
- Portion control helps reduce waste.



▶ 12 DISPENSERS PER CASE.

ITEM NO.	PRODUCT	EACH
7500 42101	800 mL Dispenser	\$29.65

GOJO® NATURAL* ORANGE™ Pumice Hand Cleaner

- Lotion formula with pumice scrubbing particles clean soils and grease.
- *Natural citrus ingredient.
- SANITARY SEALED™ refill helps prevent contamination.
- Fresh dispensing valve with each refill.



NOTE: Fits 5,000 mL dispensers. Sold separately. SEE ABOVE

ITEM NO.	PRODUCT	CASE
3540 5602	5,000 mL (2/Case)	\$91.75



GOJO® Premium Lotion Soap

A high-performance, mild lotion soap for general handwashing

- Gently removes dirt and germs.
- Dye Free with Waterfall fragrance.
- Naturally-derived moisturizer.



ITEM NO.	PRODUCT	QTY	CASE
3540 1374	800 mL Premium Lotion Soap	12 Boxes/Case	\$68.10



GOJO® TFX™ Touch Free Dispenser, 1,200 mL

Automatically dispenses the perfect amount of foam soap needed.

- Nothing for the user to touch, preventing cross-contamination.
- Dispenser features an extra-large site window making it easy to see when it's time to refill.
- Fully ADA-compliant.
- Requires two AA batteries.

▶ SEE PAGE 566
Batteries Sold Separately



ITEM NO.	PRODUCT	EACH
3540 30141	GOJO® TFX™ Touch Free Soap Dispenser	\$132.51

GOJO® E2 Foam Sanitizing Soap, 1,200 mL

A one-step foaming hand wash and sanitizing soap formulated for the food processing industry.

- Removes fats, oils and other food processing soils. • Effective against common spoilage and food borne pathogens.
- Meets guidelines for use in USDA federally regulated food processing facilities and listed with NSF International.
- Effective degreasing agent is dye-free and fragrance-free. • Kosher certified.



ITEM NO.	PRODUCT	2 PER CASE
3540 10231	GOJO® E2 Foam Sanitizing Soap, 1,200 mL	\$112.73

NOTE: Use with GOJO® TFX™ Touch-Free Dispenser. SHOWN ABOVE.

GOJO® NATURAL* ORANGE™ Pumice Hand Cleaner

- Lotion formula with scrubbing particles clean soils and grease.
- *Natural citrus ingredient.



▶ SEE PAGE 165
For 5,000 mL dispenser.
Sold separately.

ITEM NO.	PRODUCT	CASE
3540 5602	A. 5,000 mL (2/Case)	\$91.75
3540 0054	B. 1 Gallon (4/Case)	94.85

WorkHorse® E2 Foaming Antimicrobial Hand Soap

One step hand wash formulated to work with a pump system or in foaming soap dispensers.

- Rich, smooth lather effectively removes animal fats and oils.
- Meets or exceeds all USDA requirements for an E2 hand soap.
- Non-irritating, fragrance-free foam rinses quickly.



▶ 4 PER CASE.

ITEM NO.	PRODUCT	CASE
L231 0004	1 Gallon (4/Case)	\$89.95

ITEM NO.	PRODUCT	EACH
L231 00071	Foaming Hand Pump	\$12.95

Pump Dispensers for Gallon Bottles

- 1-ounce dispenser: pumps from 0.25 ounce to 1 ounce increments.
- Pump fits any 1-gallon bottle.



Adding a pump makes the 1-gallon bottle a perfect portable dispenser.

ITEM NO.	PRODUCT	EACH
6710 61001	1 oz.	\$2.95
6710 11091	0.25 oz.	3.07



SIGN UP FOR OUR eDEALS

Get exclusive offers not found anywhere else!

eDEAL SIGN-UP FORM AVAILABLE ON OUR WEBSITE.

www.bunzlpd.com

E4 Coconut Hand Soap

- Removes grease, dirt, ink and carbon.
- No abrasive, caustic or solvent material.
- Safe as a water soluble lubricant in food areas.



▶ 6 BOTTLES PER CASE.

ITEM NO.	PRODUCT	EACH
2117 02641	Coconut Hand Soap ...	\$21.25

E4 Antibacterial Hand Soap

- Contains Triclosan, an anti-bacterial agent that works continuously to prevent the spread of microbe-borne skin diseases.
- Skin conditioners soothe damaged skin and promote healing.



▶ 6 BOTTLES PER CASE.

ITEM NO.	PRODUCT	EACH
2117 02681	Antibacterial Soap.....	\$24.34

NSF E2 RATING CODE

ONE-STEP HANDWASHING AND SANITIZING PRODUCTS

Approved for use throughout the plant.

Approved for hand/food contact after handwashing.

Hands need not be washed prior to using.

After use, hands must be thoroughly rinsed with potable water.

SEE CHART ON ▶ PAGE 162
For Additional USDA Rating Codes

NEED ASSISTANCE?

Our experienced customer service representatives are available to answer your questions, find the products you are looking for, check product availability, as well as take your order.

800-456-5624

Hands-Free Industrial Dispensing System

Eliminate cross-contamination easily.

- Suitable for wet or dry environments.
- Holds a variety of 1-gallon plastic pump containers.
- Stainless steel.



Adjustable fork allows for different sized bottle or pump to be used.



A

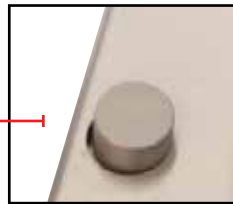

B

Single button, pushed by the foot, allows the soap to dispense.

ITEM NO.	PRODUCT	EACH
0031 0006	A. Wrist-Activated Dispenser	\$143.90
2990 01651	B. Foot-Activated Dispenser Stand	566.95

Pump Dispensers for Gallon Bottles

- 1-ounce dispenser: pumps from 0.25 ounce to 1 ounce increments.
- Pump fits any 1-gallon bottle.



Adding a pump makes the 1-gallon bottle a perfect portable dispenser.

ITEM NO.	PRODUCT	EACH
6710 61001	1 oz.	\$2.95
6710 11091	0.25 oz.	3.07

FREE GROUND SHIPPING*
when you place an order for \$500
or more from THIS BUYERS GUIDE!

*FREE SHIPPING does NOT include UPS Next Day Air, UPS 2nd Day or UPS 3rd Day Select. Certain items may not qualify. This offer is good only on orders shipped UPS Ground in the 48 contiguous states.

Based on dimensional weight, we will determine the most efficient means of shipment, either UPS or LTL.

Products may ship by truckline.

Hand and Nail Brush Kit

- 5-inch x 2-inch brush has dual level bristles for more thorough cleaning.
- Kit includes: brush, tether cord, wall mount hook for easy storage and bilingual instruction sheet with proper usage and cleaning technique.



ITEM NO.	PRODUCT	EACH
6387 22791	Hand and Nail Brush Kit	\$20.84

Hand and Nail Brush

- Features long and short polypropylene stiff bristles.
- White plastic block style, 1-1/2 inches x 3-1/2 inches.



ITEM NO.	PRODUCT	EACH
6387 39001	Hand and Nail Brush	\$2.36

Stainless Steel Wall Mount Gallon Bottle Dispenser Holder

- Gallon bottle slips easily into holder and is held securely in place.
- Holds a standard 1-gallon plastic soap container.
- 6-1/2 inches L x 6-1/2 inches W x 12 inches H.



ITEM NO.	PRODUCT	EACH
2990 2687	Gallon Bottle Dispenser Holder . . .	\$80.15

Stainless Steel Wall Mount Holder with Pump Soap Dispenser

- 16-ounce pump bottle can be refilled with soaps and easily cleaned and replaced.
- Electropolished to enhance corrosion resistance.
- 2-7/8 inches x 2-7/8 inches x 5-1/2 inches H.

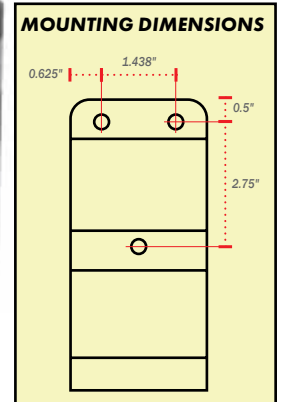

ITEM NO.	PRODUCT	EACH
3013 0563	SS Holder and Pump Soap Dispenser	\$43.85
3013 5631	Replacement 16 oz. Bottle and Pump.	11.55

QuikFlo™ Automatic Faucet Control

Avoid cross-contamination, hands don't touch faucet handles.

- Push stainless steel rod for instant water flow, release for instant shut-off.
- Fits all faucets (dual-threaded), installs in minutes.



ITEM NO.	PRODUCT	EACH
E538 30031	3-1/2" (Fits Regular Faucets)	\$40.25
E538 30051	5" (Fits Tall Faucets)	34.95

CLEAN HANDS. Guaranteed.



Remove 99.9% of pathogens with CleanTech® fully-automated handwashing stations.



Effective
Clinically proven to remove 99.9% of harmful pathogens from hands in 12-seconds. No need to sanitize!

Easy to Use
Standardizes the hygiene process and makes compliance monitoring documentation effortless.

Eco-Friendly
Uses up to 75% less water and produces up to 75% less waste while maximizing energy efficiency.



Scan this code with your smartphone to learn more about CleanTech®.



F.O.B. FACTORY

ITEM NO.	PRODUCT	MFR. NO.	NOTES
4435 0001	A. CleanTech® 500EZ Automated Handwashing Station	500EZ	Single Bay
4435 0002	B. CleanTech® 2000S Automated Handwashing Station	2000S	Single Bay w/Self-Clean Feature
4435 0011	C. UltraPure Hand Hygiene Solution (Case of 4, 1-Gallon Bottles)	202	Used in ALL Handwashing Systems
4435 0010	UltraPure Hand Hygiene Solution (One, 2.5-Gallon Jug)	202-10L	Used in ALL Handwashing Systems
4435 0009	D. SelfClean Solution (Case of 4, 1-Gallon Bottles)	301	Used for Self-Clean feature in 4435 0002. Also used for the Footwear Sanitizing Pan



Multiple Styles Available

CALL 800-456-4524 FOR MORE INFORMATION

www.bunzlpd.com



Sani-Lav Wall Mount Hand-Wash Sinks

Certified NSF/ANSI 372 low-lead and NSF/ANSI Standard 2 Food Equipment

- Includes accessories, fixtures, wall mounting bracket and strainer assembly with basket.
- Heavy-duty 18- and 16-gauge construction.

SANI-LAV
COLUMBIA
PRODUCTS



All models available with AC or battery-powered sensors.

Single Knee Pedal Valve: Includes easy-to-use single pedal mixing valve delivers a pre-set pressurized stream of water.

Battery-Powered Sensor: Hands-free, sanitary design. No handles to turn or pedals to push.



ITEM NO.	OVERALL DIMENSIONS	INSIDE BOWL DIMENSIONS	GAUGE	FINISH	WATER ACTIVATED	EACH
3013 0605	A. 16" x 11" x 13"	11" x 14" x 5"	18	Electropolished	Single Knee Pedal Valve	\$538.23
3013 0088	16" x 11" x 13"	11" x 14" x 5"	18	Electropolished	Double Knee Pedal Valve	674.30
3013 1605	16" x 11" x 13"	11" x 14" x 5"	18	Electropolished	Industrial Faucet w/4" Swing Levers	563.05
3013 0196	16" x 11" x 13"	11" x 14" x 5"	18	Electropolished	Battery Powered Sensor	1,523.05
3013 5051	B. 19" x 18" x 16-1/2"	14" x 17" x 7"	18	Electropolished	Single Knee Pedal Valve	920.77
3013 0505	19" x 18" x 16-1/2"	14" x 17" x 7"	18	Electropolished	Double Knee Pedal Valve	988.78
3013 0080	19" x 18" x 16-1/2"	14" x 17" x 7"	18	Electropolished	Industrial Faucet w/4" Swing Levers	1,241.20
3013 1505	19" x 18" x 16-1/2"	14" x 17" x 7"	18	Electropolished	Battery Powered Sensor	1,787.23
3013 0081	C. 20" x 17-1/2" x 16-1/2"	14" x 17" x 7"	16	Satin	Single Knee Pedal Valve	1,179.75
3013 0082	20" x 17-1/2" x 16-1/2"	14" x 17" x 7"	16	Satin	Double Knee Pedal Valve	1,154.81
3013 0083	20" x 17-1/2" x 16-1/2"	14" x 17" x 7"	16	Satin	Industrial Faucet w/4" Swing Levers	1,129.99
3013 0087	20" x 17-1/2" x 16-1/2"	14" x 17" x 7"	16	Satin	Battery Powered Sensor	1,920.72
3013 0086	D. 23" x 20-1/2" x 19-1/2"	17" x 20" x 9"	16	Satin	Single Knee Pedal Valve	1,438.75
3013 0084	23" x 20-1/2" x 19-1/2"	17" x 20" x 9"	16	Satin	Double Knee Pedal Valve	1,414.45
3013 0093	23" x 20-1/2" x 19-1/2"	17" x 20" x 9"	16	Satin	Industrial Faucet w/4" Swing Levers	1,531.15
3013 0028	23" x 20-1/2" x 19-1/2"	17" x 20" x 9"	16	Satin	Battery Powered Sensor	2,140.15
3013 0089	E. 22" x 19" x 14"	19" x 15-1/2" x 5"	16	Satin	Single Knee Pedal Valve	1,285.05
3013 0197	22" x 19" x 14"	19" x 15-1/2" x 5"	16	Satin	Double Knee Pedal Valve	1,216.85
3013 0090	22" x 19" x 14"	19" x 15-1/2" x 5"	16	Satin	Industrial Faucet w/4" Swing Levers	1,175.15
3013 0085	22" x 19" x 14"	19" x 15-1/2" x 5"	16	Satin	Battery Powered Sensor	1,765.75

SANI-LAV
COLUMBIA
PRODUCTS

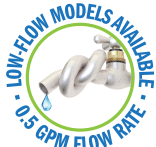

Sani-Lav Floor Mount Hand-Wash Sinks

Certified NSF/ANSI 372 low-lead and NSF/ANSI Standard 2 Food Equipment

- Heavy-duty 18- and 16-gauge construction.
- Includes accessories, fixtures and strainer assembly with basket.



All models available with AC or battery-powered sensors.



Battery-Powered Sensor: Hands-free, sanitary design. No handles to turn or pedals to push.



Double Foot Pedal Valve: Includes easy-to-use pedals that deliver a pressurized stream of water.

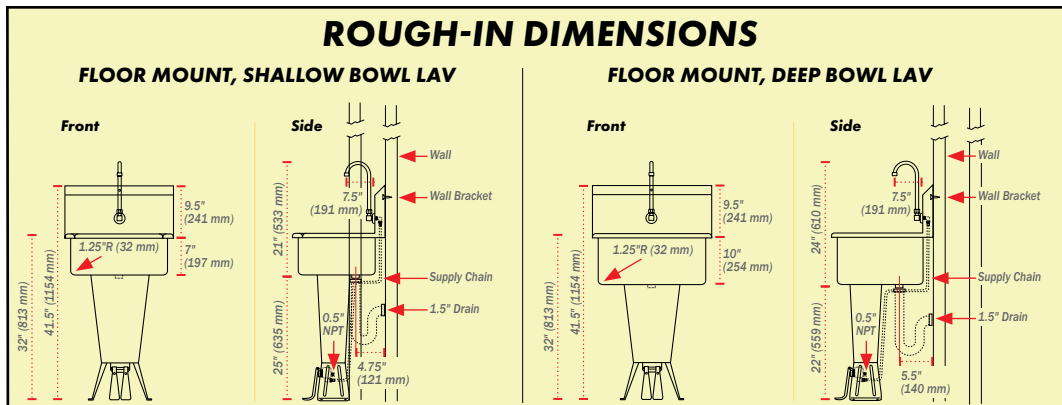

ITEM NO.	OVERALL DIMENSIONS	INSIDE BOWL DIMENSIONS	GAUGE	FINISH	WATER ACTIVATED	EACH
3013 5011	A. 19" x 18" x 41-1/2"	14" x 17" x 7"	18	Electropolished	Single Foot Pedal Valve	\$1,297.05
3013 0501	19" x 18" x 41-1/2"	14" x 17" x 7"	18	Electropolished	Double Foot Pedal Valve	1,085.15
3013 0099	19" x 18" x 41-1/2"	14" x 17" x 7"	18	Electropolished	Industrial Faucet w/4" Swing Levers	1,299.62
3013 1501	19" x 18" x 41-1/2"	14" x 17" x 7"	18	Electropolished	Battery Powered Sensor	1,870.25
3013 0130	B. 21" x 20" x 41-1/2"	16" x 19" x 10"	18	Electropolished	Single Foot Pedal Valve	1,522.52
3013 0521	21" x 20" x 41-1/2"	16" x 19" x 10"	18	Electropolished	Double Foot Pedal Valve	1,221.65
3013 0136	21" x 20" x 41-1/2"	16" x 19" x 10"	18	Electropolished	Industrial Faucet w/4" Swing Levers	1,494.69
3013 0139	21" x 20" x 41-1/2"	16" x 19" x 10"	18	Electropolished	Battery Powered Sensor	2,282.25
3013 0113	C. 20" x 17-1/2" x 43-1/2"	14" x 17" x 7"	16	Satin	Single Foot Pedal Valve	1,579.65
3013 0118	20" x 17-1/2" x 43-1/2"	14" x 17" x 7"	16	Satin	Double Foot Pedal Valve	1,515.59
3013 0120	20" x 17-1/2" x 43-1/2"	14" x 17" x 7"	16	Satin	Industrial Faucet w/4" Swing Levers	1,536.85
3013 0125	20" x 17-1/2" x 43-1/2"	14" x 17" x 7"	16	Satin	Battery Powered Sensor	2,284.55
3013 0143	D. 23" x 20-1/2" x 46-1/2"	17" x 20" x 9"	16	Satin	Single Foot Pedal Valve	1,818.85
3013 0148	23" x 20-1/2" x 46-1/2"	17" x 20" x 9"	16	Satin	Double Foot Pedal Valve	1,826.95
3013 0152	23" x 20-1/2" x 46-1/2"	17" x 20" x 9"	16	Satin	Industrial Faucet w/4" Swing Levers	1,955.68
3013 0153	23" x 20-1/2" x 46-1/2"	17" x 20" x 9"	16	Satin	Battery Powered Sensor	2,481.15



Stainless Steel Wall Mount Wash-Stations

Certified NSF/ANSI 372 low-lead and NSF/ANSI Standard 2 Food Equipment.

- Heavy-duty 16-gauge construction with a uniform satin finish.
- Water activation from chart below.
- Includes accessories and fixtures, wall mounting bracket, strainer assembly with basket.
- Chose either single knee pedal valve, double knee pedal valve, manual faucet, AC or battery-powered sensor.
- Chose 2, 3, 4, 5 or 6 person with the type of water activation.

SANI-LAV
COLUMBIA
PRODUCTS

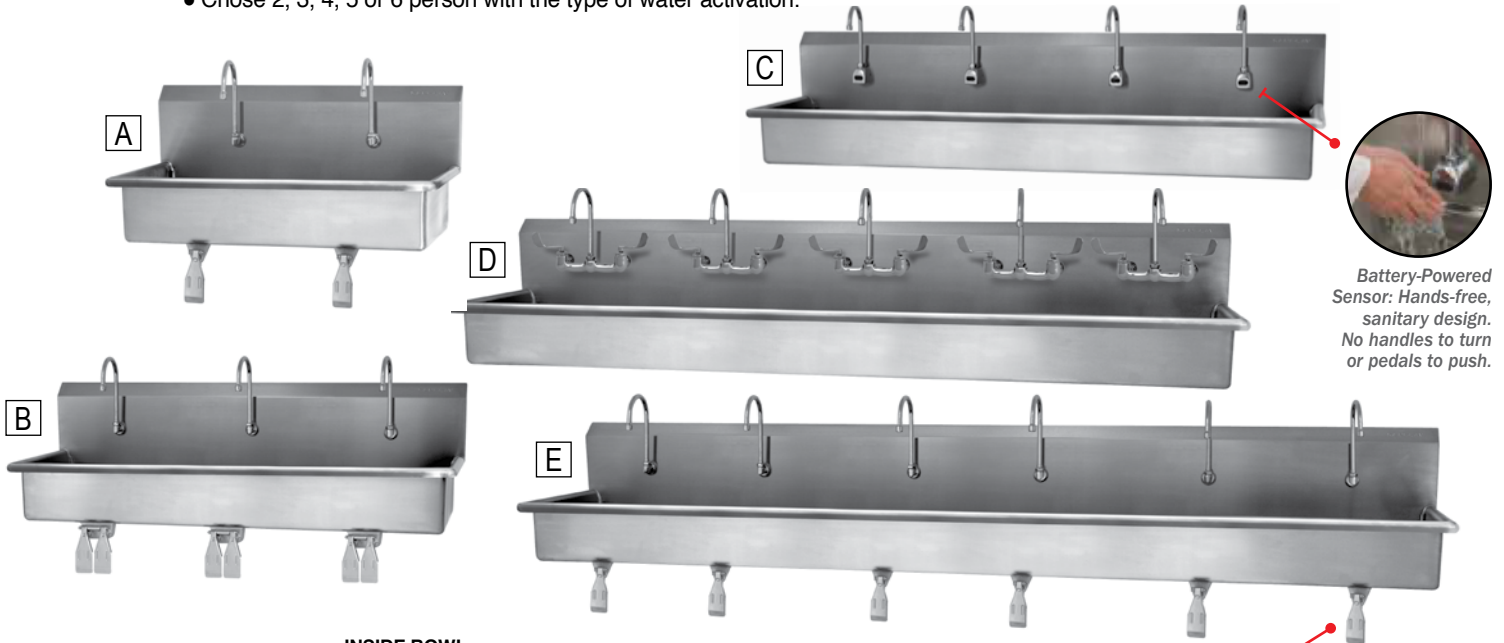

Battery-Powered Sensor: Hands-free, sanitary design. No handles to turn or pedals to push.



Single Knee Pedal Valve: Includes easy-to-use single pedal mixing valve delivers a pre-set pressurized stream of water.

ITEM NO.	OVERALL DIMENSIONS	INSIDE BOWL DIMENSIONS	STATIONS	WATER ACTIVATED	EACH
3013 0068	A. 40" x 20" x 18"	37" x 16-1/2" x 8"	2	Single Knee Pedal Valve	\$2,836.95
3013 5042	40" x 20" x 18"	37" x 16-1/2" x 8"	2	Double Knee Pedal Valve	2,871.65
3013 0096	40" x 20" x 18"	37" x 16-1/2" x 8"	2	Industrial Faucet w/4" Swing Levers	3,325.85
3013 0054	40" x 20" x 18"	37" x 16-1/2" x 8"	2	Battery Powered Sensor	4,507.95
3013 0067	B. 60" x 20" x 18"	57" x 16-1/2" x 8"	3	Single Knee Pedal Valve	3,529.15
3013 0052	60" x 20" x 18"	57" x 16-1/2" x 8"	3	Double Knee Pedal Valve	3,987.95
3013 0098	60" x 20" x 18"	57" x 16-1/2" x 8"	3	Industrial Faucet w/4" Swing Levers	4,049.25
3013 0027	60" x 20" x 18"	57" x 16-1/2" x 8"	3	Battery Powered Sensor	6,085.45
3013 0038	C. 80" x 20" x 18"	77" x 16-1/2" x 8"	4	Single Knee Pedal Valve	4,724.05
3013 0069	80" x 20" x 18"	77" x 16-1/2" x 8"	4	Double Knee Pedal Valve	4,556.55
3013 0109	80" x 20" x 18"	57" x 16-1/2" x 8"	4	Industrial Faucet w/4" Swing Levers	5,080.05
3013 0029	80" x 20" x 18"	57" x 16-1/2" x 8"	4	Battery Powered Sensor	9,218.15
3013 0116	D. 100" x 20" x 18"	97" x 16-1/2" x 8"	5	Single Knee Pedal Valve	6,196.35
3013 0114	100" x 20" x 18"	97" x 16-1/2" x 8"	5	Double Knee Pedal Valve	6,258.75
3013 0141	100" x 20" x 18"	97" x 16-1/2" x 8"	5	Industrial Faucet w/4" Swing Levers	6,567.35
3013 0510	100" x 20" x 18"	97" x 16-1/2" x 8"	5	Battery Powered Sensor	9,994.85
3013 0144	E. 120" x 20" x 18"	117" x 16-1/2" x 8"	6	Single Knee Pedal Valve	7,005.25
3013 0142	120" x 20" x 18"	117" x 16-1/2" x 8"	6	Double Knee Pedal Valve	7,069.95
3013 0145	120" x 20" x 18"	117" x 16-1/2" x 8"	6	Industrial Faucet w/4" Swing Levers	7,402.85
3013 0147	120" x 20" x 18"	117" x 16-1/2" x 8"	6	Battery Powered Sensor	11,538.65



ADA-Compliant Wall Mount Wash-Stations

ITEM NO.	OVERALL DIMENSIONS	INSIDE BOWL DIMENSIONS	STATIONS	WATER ACTIVATED	EACH
3013 0166	30" x 20" x 15"	27" x 16-1/2" x 5"	1	Battery Powered Sensor	\$2,177.15
3013 0154	30" x 20" x 15"	27" x 16-1/2" x 5"	1	Industrial Faucet w/4" Swing Levers	1,660.55
3013 0123	48" x 20" x 15"	27" x 16-1/2" x 5"	2	Battery Powered Sensor	3,607.75
3013 0126	48" x 20" x 15"	27" x 16-1/2" x 5"	2	Industrial Faucet w/4" Swing Levers	2,857.85
3013 0188	68" x 20" x 15"	27" x 16-1/2" x 5"	3	Battery Powered Sensor	4,702.25
3013 0128	68" x 20" x 15"	27" x 16-1/2" x 5"	3	Industrial Faucet w/4" Swing Levers	3,737.15



Stainless Steel Floor Mount Wash-Stations

Certified NSF/ANSI 372 low-lead and NSF/ANSI Standard 2 Food Equipment.

- Heavy-duty 16-gauge construction with a uniform satin finish.
- Water activation from chart below.
- Includes accessories and fixtures, strainer assembly with basket.
- Chose 2, 3, 4, 5 or 6 person with the type of water activation.
- Chose either single foot pedal valve, double foot pedal valve, manual faucet, AC or battery-powered sensor.

SANI-LAV
COLUMBIA
PRODUCTS



STAINLESS STEEL WASH STATIONS

ITEM NO.	OVERALL DIMENSIONS	INSIDE BOWL DIMENSIONS	STATIONS	WATER ACTIVATED	F.O.B. FACTORY
					EACH
3013 0033	A. 40" x 20" x 45"	37" x 16-1/2" x 8"	2	Single Foot Pedal Valve	\$3,704.85
3013 5040	40" x 20" x 45"	37" x 16-1/2" x 8"	2	Double Foot Pedal Valve	3,734.85
3013 0094	40" x 20" x 45"	37" x 16-1/2" x 8"	2	Industrial Faucet w/4" Swing Levers	3,847.05
3013 0060	40" x 20" x 45"	37" x 16-1/2" x 8"	2	Battery Powered Sensor	5,530.75
3013 0131	B. 60" x 20" x 45"	57" x 16-1/2" x 8"	3	Single Foot Pedal Valve	4,634.05
3013 0056	60" x 20" x 45"	57" x 16-1/2" x 8"	3	Double Foot Pedal Valve	4,719.45
3013 0132	60" x 20" x 45"	57" x 16-1/2" x 8"	3	Industrial Faucet w/4" Swing Levers	4,976.05
3013 0059	60" x 20" x 45"	57" x 16-1/2" x 8"	3	Battery Powered Sensor	6,971.75
3013 0133	C. 80" x 20" x 45"	77" x 16-1/2" x 8"	4	Single Foot Pedal Valve	6,136.25
3013 5080	80" x 20" x 45"	77" x 16-1/2" x 8"	4	Double Foot Pedal Valve	4,652.45
3013 0134	80" x 20" x 45"	77" x 16-1/2" x 8"	4	Industrial Faucet w/4" Swing Levers	6,607.75
3013 0061	80" x 20" x 45"	77" x 16-1/2" x 8"	4	Battery Powered Sensor	10,198.15
3013 0135	D. 100" x 20" x 45"	97" x 16-1/2" x 8"	5	Single Foot Pedal Valve	7,777.25
3013 0026	100" x 20" x 45"	97" x 16-1/2" x 8"	5	Double Foot Pedal Valve	7,721.75
3013 0137	100" x 20" x 45"	97" x 16-1/2" x 8"	5	Industrial Faucet w/4" Swing Levers	8,256.75
3013 0138	100" x 20" x 45"	97" x 16-1/2" x 8"	5	Battery Powered Sensor	10,656.95
3013 0140	E. 120" x 20" x 45"	117" x 16-1/2" x 8"	6	Single Foot Pedal Valve	8,716.75
3013 5120	120" x 20" x 45"	117" x 16-1/2" x 8"	6	Double Foot Pedal Valve	7,224.85
3013 0091	120" x 20" x 45"	117" x 16-1/2" x 8"	6	Industrial Faucet w/4" Swing Levers	9,234.35
3013 0198	120" x 20" x 45"	117" x 16-1/2" x 8"	6	Battery Powered Sensor	12,926.57

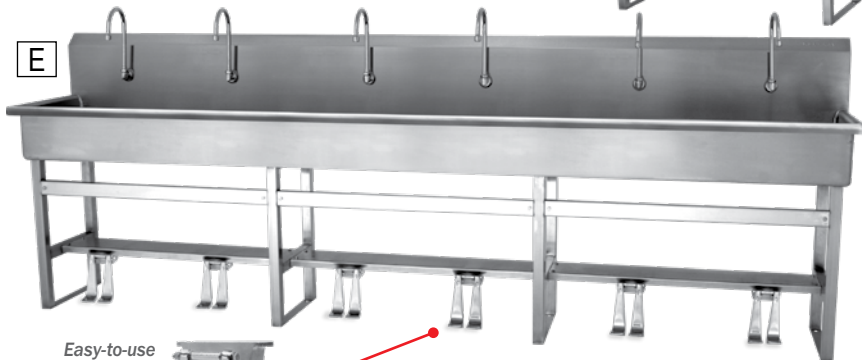

Easy-to-use double pedals deliver a pressurized stream of water.

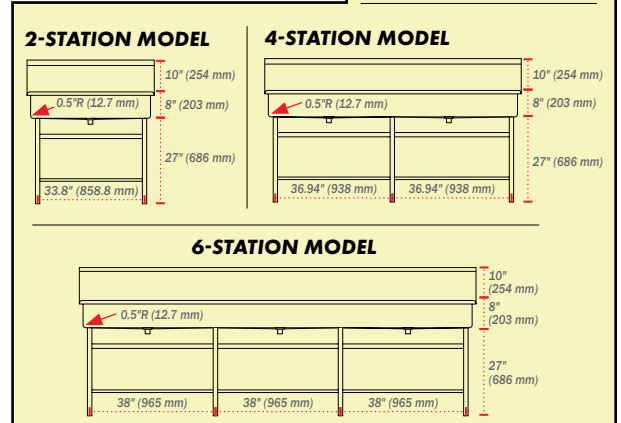
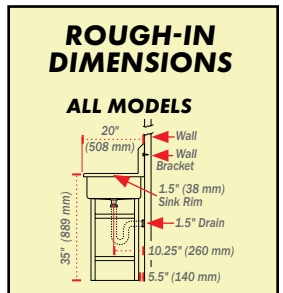

Stainless Steel Skullery Compartment Sinks

- Constructed of 16-gauge, type 304 stainless steel. • All seams are TIG welded and ground to a smooth #4 satin finish.
- Sink compartments are square cornered. • Leg sockets are welded directly to sink body providing proper load support.
- Backsplash is 8 inches tall with a 2 inch wide return. • Sanitary rolled rim is 1-1/2 inches wide and 2 inches tall. • Flood level is 14 inches.
- Unibody construction provides maximum durability. • Drain openings are 3-1/2 inches, recessed. • Basket drains are 1-1/2 inches IPS.
- Faucet holes are 1-1/8 inch diameter, drilled on 8 inch centers. (sold separately). • Drainboard(s) are pitched to drain into adjacent sink bowl.
- Sink legs are 1-5/8 inch diameter with adjustable feet. • Supply is 1/2 inch IPS, hot and cold.

One-Compartment Stainless Steel Sink



F.O.B. FACTORY

ITEM NO.	DIMENSIONS	WEIGHT	EACH
3048 8181	18" x 18" x 14"	38 lb.	\$674.96
3048 4242	24" x 24" x 14"	57 lb.	761.54

Two-Compartment Stainless Steel Sink



▶ SEE PAGE 177
Faucet Sold Separately



F.O.B. FACTORY

ITEM NO.	DIMENSIONS	WEIGHT	EACH
3048 8374	18" x 18" x 14"	71 lb.	\$966.91
3048 8242	24" x 24" x 14"	85 lb.	1,176.62

Three-Compartment Stainless Steel Sink

NOTE: NSF sinks available upon request.



▶ SEE PAGE 177
Faucet Sold Separately



F.O.B. FACTORY

ITEM NO.	DIMENSIONS	WEIGHT	EACH
3048 4183	18" x 18" x 14"	.81 lb.	\$1,267.19

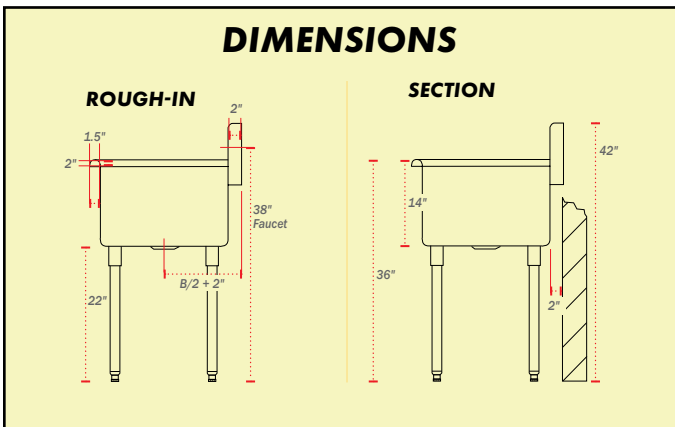



FREE GROUND SHIPPING
when you place an order for \$500
or more from **THIS BUYERS GUIDE!**

*FREE SHIPPING does NOT include UPS Next Day Air, UPS 2nd Day or UPS 3rd Day Select. Certain items may not qualify. This offer is good only on orders shipped UPS Ground in the 48 contiguous states. Based on dimensional weight, we will determine the most efficient means of shipment, either UPS or LTL. Products may ship by truckline.

Foot And Knee Pedal Valves

Certified NSF/ANSI 372 low-lead and NSF/ANSI Standard 2 Food Equipment.

- Start and stop the flow of water “hands-free” by pressing a foot or knee pedal to start the flow of water and release to stop the flow.
- Ideal for use in the food service industries. • Cast brass with stainless steel springs, pedals, bolts and nuts.
- Self-closing foot-operated valves eliminate the possibility of contamination from germ laden or dirty faucets.
- All valves are tested at 150 psi after assembly. • Lift-up pedals make for easy cleaning.



Model 3013 0105

1/2-Inch NPT Inlets

Model 3013 0112

1/2-Inch NPT Inlet

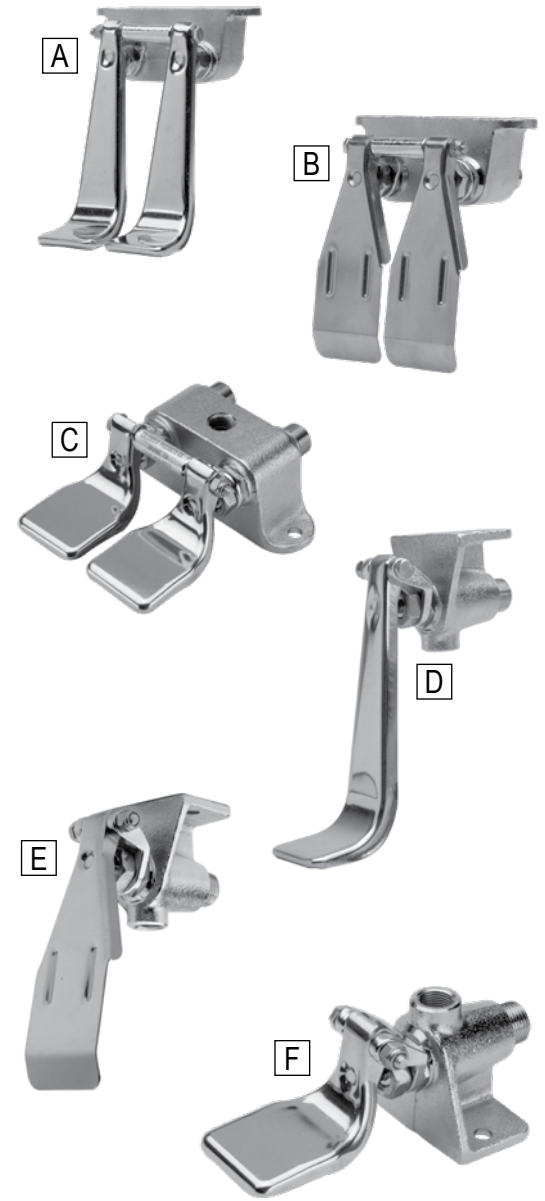
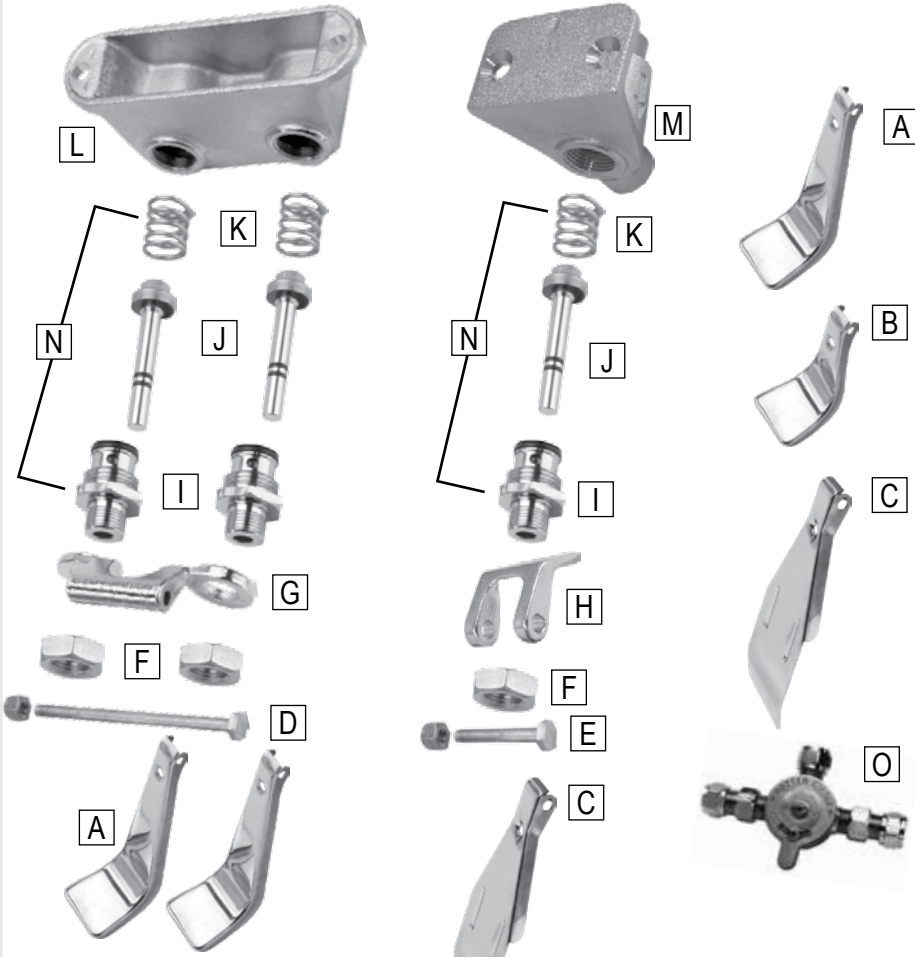

ITEM NO.	PRODUCT	EACH
3013 1041	A. Long Foot Pedal	\$25.45
3013 1042	B. Short Foot Pedal Valve	25.35
3013 1043	C. Knee Pedal	25.45
3013 1051	D. Bolt & Nut Set for Double Valves	3.35
3013 00391	E. Bolt & Nut Set for Single Valves	3.72
3013 1050	F. Jam Nut for All Valves	3.35
3013 1052	G. Double Valve Bracket	20.85
3013 10541	H. Single Valve Bracket	18.55
3013 1053	I. Threaded Insert for Single & Double Valves	38.05
3013 1055	J. Plunger Assembly for Single & Double Valves	25.35
3013 1056	K. Stainless Steel Spring for Single & Double Valves	8.05
3013 1057	L. Double Valve Body Only	147.75
3013 1058	M. Single Valve Body Only	97.05
3013 10611	N. Valve Repair Kit (Sold One Each and Fits Hot or Cold Side)	48.05
3013 0201	O. Manual Mixing Check Valve	55.78

ITEM NO.	PRODUCT	EACH
3013 0105	A. Double Foot Pedal Valve	\$190.65
3013 0111	B. Double Knee Pedal Valve	190.65
3013 01581	C. Short Double Foot Pedal	194.45
3013 0106	D. Single Foot Pedal Valve	171.05
3013 0112	E. Single Knee Pedal Valve	147.95
3013 11021	F. Short Single Foot Pedal Valve	188.45

Front Mount Replacement Gooseneck and Aerator

- Chrome plated, includes aerator.
- 5-3/4-inch swivel spout.
- Certified NSF Standard 2 Food Equipment and NSF/ANSI 372 low lead.
- LOW LEAD

▶ SEE PAGE 170-174
Fits Lavatories and Wash Stations



ITEM NO.	PRODUCT	EACH
3013 20031	Replacement Gooseneck	\$78.45
3013 1002	Replacement Aerator	5.25

Chrome-Plated Swivel Faucet, 5-3/4 Inch

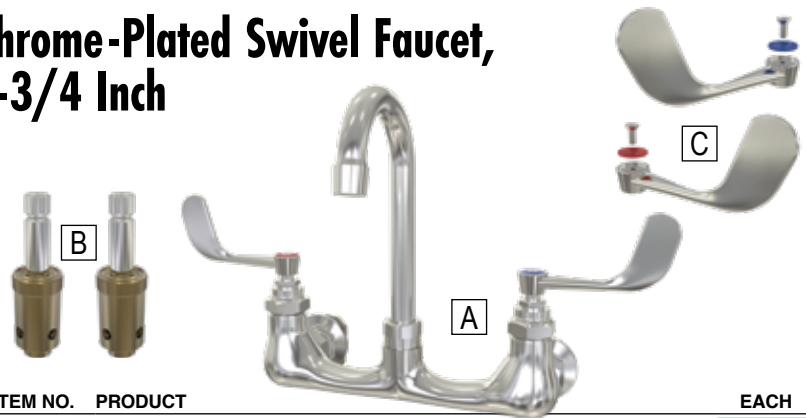

ITEM NO.	PRODUCT	EACH
3013 01651	A. 5-3/4" Spout, 8" In-Flow Center Set.	\$288.85
3013 01491	B. Faucet Valve Repair Kit Hot and Cold	51.85
3013 01551	C. 4" Wrist Handle Repair Kit Hot and Cold	35.17

Chrome-Plated, 12-Inch Swivel Faucet

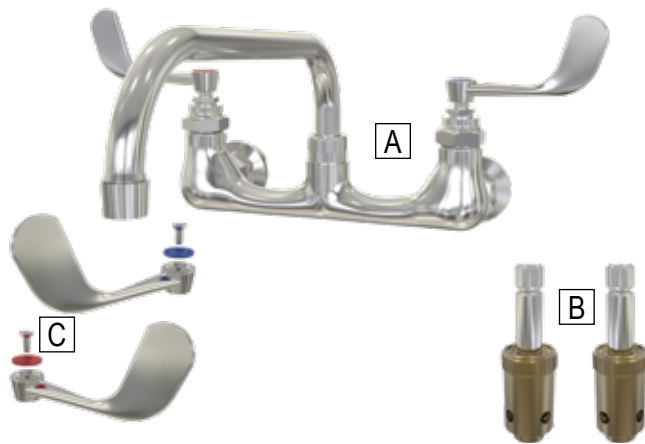

ITEM NO.	PRODUCT	EACH
3013 0205	A. 12" Spout, 8" In-Flow Center Set.	\$290.29
3013 01491	B. Faucet Valve Repair Kit Hot and Cold	51.85
3013 01551	C. 4" Wrist Handle Repair Kit Hot and Cold	35.17

Chrome-Plated, 5-Inch Swivel Faucet

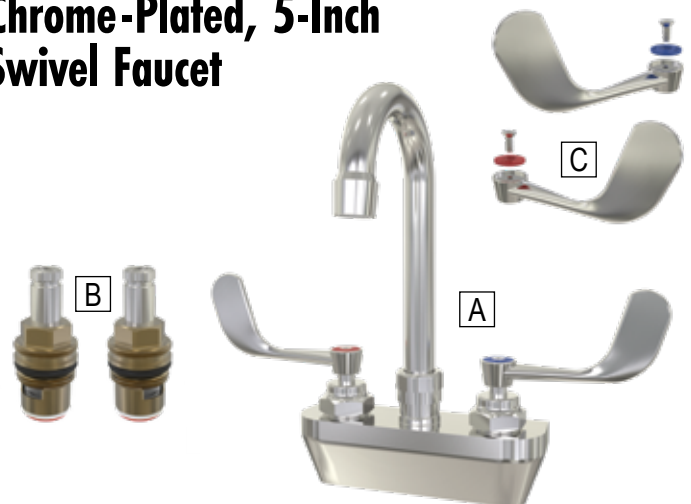

ITEM NO.	PRODUCT	EACH
3013 01851	A. 5" Spout, 4" In-Flow Center Set.	\$242.65
3013 01571	B. Faucet Valve Repair Kit Hot and Cold	34.65
3013 01551	C. 4" Wrist Handle Repair Kit Hot and Cold	35.17

Chrome-Plated Butterfly Faucet

- Adjustable inflow valves fit virtually any size sink.
- Handy hook for convenient filling of buckets or pails.
- GHT on nozzle, so hose can be easily attached to it. • Shipping weight: 7 pounds.



GHT threads for easy hose connection.



Bucket handle hang hook allows for hands-free filling.



Bottom installation.



Off-center installation.



Top installation.

ITEM NO.	PRODUCT	EACH
3569 69011	Adjustable Butterfly Faucet.	\$531.92

Knife Sterilizer Boxes

- All knife sterilizers are constructed of heavy-duty 16-gauge stainless steel.
- Electropolished finish to enhance corrosion resistance, improve surface finish and ease of cleaning.
- All knife sterilizers are NSF certified. • Heating element guards included.

Table Top or Wall Mount Sterilizer Box

- Includes removable slotted knife support.
- Overall height: 18 inches. • Overall width: 14-3/4 inches.
- Box size: 6 inches W x 12 inches L x 12 inches D.



NOTE:
Removable slotted knife support INCLUDED!



ITEM NO.	PRODUCT	EACH
3013 0567	Wall/Table Sterilizer Box w/Removable Slotted Knife Support	\$367.35
3013 0564	Replaceable Slotted Knife Support	98.25

Side of Sink, Counter Top or Wall Mount Sterilizer Box

- Box size: 6 inches W x 12 inches L x 12 inches D.
- Wall mounting bracket sold separately.



Optional slotted knife support sold separately.



ITEM NO.	PRODUCT	EACH
3013 0552	Side of Sink, Counter Top or Wall Mount Sterilizer Box.	\$214.85
3013 0564	Optional Slotted Knife Support	98.25
3013 7305	Optional Wall Mounting Bracket, 10" x 12" H	43.95

Sink or Wall Mount Sterilizer Box

- Box size: 5 inches W x 8 inches L x 8 inches D.



Optional wall mounting bracket does not include hardware.



Works best with any 1100 W box heater shown right.

NOTE:
Wall mounting bracket sold separately.



ITEM NO.	PRODUCT	EACH
3013 0555	Sink or Wall Mount Knife Sterilizer Box	\$168.18
3013 7305	Optional Wall Mounting Bracket, 10" x 12" H	43.95

Combo Knife Sterilizer Box with 1100 Watt Heating Element

- Box size: 5 inches W x 8 inches L x 8 inches D.
- Designed for sink or wall mount.



ITEM NO.	PRODUCT	EACH
3013 05581	Combo Knife Sterilizer Box w/Heating Element	\$254.40

Rust-Proof Knife Box Heaters

Guaranteed to heat faster and last longer than any competing heating elements!

- Stands up to day in, day out abuse. • Furnished with 6-foot grounded cord and plug. 110 V AC.
- Fits a 1-inch NPT and is supplied with thicker gasket. • Watertight, grounded cord.
- Pre-set thermostat maintains 180 °F hot water. • Will not rust!
- Waterproof for wash down.

SANI-LAV
COLUMBIA
PRODUCTS



Reinforced and sealed rustproof housing



Reinforced stainless cord connection, stainless jam nut and poly sealing washer.

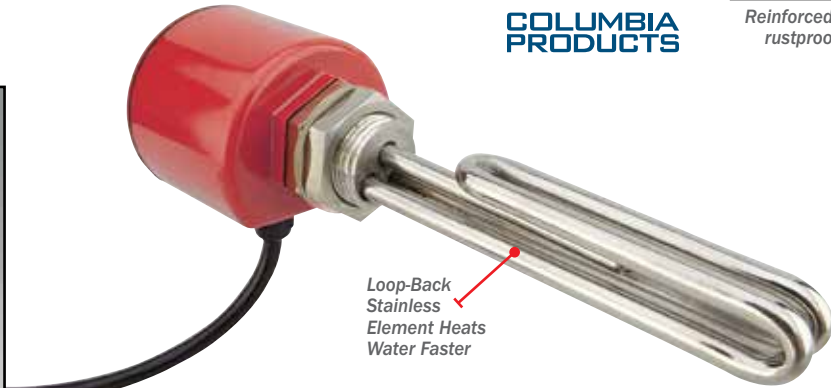

Loop-Back Stainless Element Heats Water Faster



Use with Knife Sterilizer box. Sold Separately.

ITEM NO.	PRODUCT	EACH
3013 11031	1100 Watt, 5" Element	\$95.85
3013 20001	2000 Watt, 6-1/4" Element	124.75

Stainless Steel Thermostatically Controlled Knife Sterilizer Box Heaters

- Furnished with 6-foot, 3-wire grounded cord and plug. 110 V AC.
- Stainless steel heating element and housing. • Water-resistant housing.

SANI-LAV
COLUMBIA
PRODUCTS



Furnished with a stainless lock nut and gasket to fit 1-inch NPT.



External thermostat control knob makes adjusting water temperature easy.

ITEM NO.	PRODUCT	EACH
3013 1100	1100 Watt, 5-1/2" Element	\$149.33
3013 1500	1500 Watt, 7" Element	156.72

Thermostatically Controlled Knife Sterilizer Box Heaters

- Furnished with 6-foot, 3-wire grounded cord and plug. 110 V AC. • Element with rubber cover is moisture proof.
- External thermostat control knob. • Made of plated copper.

MADE IN
USA



ITEM NO.	PRODUCT	EACH
3090 03391	1100 Watt, 5-1/2" Element	\$139.95
3090 81261	1100 Watt, 5-1/2" Element w/Rubber Cover	171.95
3090 06891	1500 Watt, 7" Element	144.95

Twin JRT Dispenser

- Locking mechanism to reduce theft.
- Stub roll feature to reduce waste.
- Back-up roll to reduce run-outs.
- Virtually indestructible.
- Translucent cover to monitor tissue supply.
- ADA-compliant.
- Holds two 9-inch diameter rolls.



NOTE: Use with the 2-Ply Jumbo Roll Tissue. SEE RIGHT.



Metal dual function lock that can become a keyless push button.

F.O.B. FACTORY

ITEM NO.	PRODUCT
K633 0017	Twin JRT Dispenser

EACH
\$96.74

2-Ply Jumbo Roll Tissue

- 1,000-foot rolls.
- Core: 3-3/10 inches.



NOTE: Use with the Twin JRT Dispenser. SEE LEFT.

▶ 12 ROLLS PER CASE - 48 CASES PER PALLET.

ITEM NO.	PRODUCT	CASE
K633 0007	1,000' Jumbo Tissue Roll	\$92.11

Premium Roll Towels

- 1,000-foot rolls.



NOTE: Use with the Towel Dispenser. SEE RIGHT.



▶ 6 ROLLS PER CASE - 55 CASES PER PALLET.

ITEM NO.	PRODUCT	CASE
K633 0005	1,000' Premium Roll Towels	\$136.13

Brown Roll Towels

- 800-foot rolls.

NOTE: Use with the Towel Dispenser. SEE RIGHT.



▶ 12 ROLLS PER CASE - 35 CASES PER PALLET.

ITEM NO.	PRODUCT	CASE
K633 0002	800' Brown Roll Towels	\$120.98

Towel Dispenser

- Smooth cut.
- Tested for 350,000 pulls.
- No clear plastic lens.
- Hands-free with back up push paddle.
- Touch only the towel you use.
- Sturdy cover for easier pressure washing.
- ADA-compliant.
- More water-resistant than other brands.
- Long paper tail and low pull force reduce tabbing.



Holds up to 1,000 feet of toweling to reduce maintenance

ITEM NO.	PRODUCT	F.O.B. FACTORY EACH
K633 0018	Towel Dispenser	\$59.18



**VIRTUALLY
INDESTRUCTIBLE**

Centerpull Dispenser

The simplest, most cost-effective, hands-free system available.

- Easy to load. • Portion controlling. • No moving parts to wear out.
- Waterproof. • Hands-free — touch only the towel you use. • Easy to mount, hard to dismount.
- No moving parts — no batteries to replace. • Reliable for hundreds of thousands of pulls.
- Removable backing plate for ease of installation. • ADA-compliant.



F.O.B. FACTORY
EACH

ITEM NO.	PRODUCT	F.O.B. FACTORY EACH
K633 0016	Centerpull Towel Dispenser	\$71.90

1-Ply Centerpull Towels

- 1,000-foot rolls.

**NOTE: Use with the
Centerpull Dispenser.
SEE ABOVE.**



▶ 6 ROLLS PER CASE - 55 CASES PER PALLET.

ITEM NO.	PRODUCT	CASE
K633 0019	1,000' Centerpull Towels	\$102.19

1-Ply Multi-Fold Towels

- Embossed for increased absorbency.
- Increased wet strength. • 9-1/8 inches x 9-1/2 inches.

**NOTE:
Use with the
Multi-Fold Towel
Dispenser.
SEE RIGHT.**



▶ 250 TOWELS PER PACK - 16 PACKS PER CASE.

ITEM NO.	PRODUCT	CASE
1410 0538	Multi-Fold Towels	\$49.72

Multi-Fold or C-Fold Towel Dispenser

- Holds up to 500 multi-fold or 300 C-fold towels.
- Fits towels up to 10-1/4 inches. • Double latch key lock.
- Durable steel base with transparent textured cover.
- Dimensions: 15-1/4 inches H x 11-1/4 inches W x 5-1/4 inches D.



**NOTE: Use with the
Multi-Fold Towels.
SEE LEFT.**

▶ 6 DISPENSERS PER CASE.

F.O.B. FACTORY

ITEM NO.	PRODUCT	CASE
7159 0175	Multi-Fold Towel Dispenser	\$252.00

2-Ply Bath Tissue

- 156.3 feet per roll.
- 500 sheets per roll.
- Sheet size: 4 inches x 3-4/5 inches.



▶ 96 ROLLS PER CASE.

ITEM NO.	PRODUCT	CASE
1410 1615	2-Ply Bath Tissue.....	\$95.84



Plastic Lever Action Paper Roll Dispenser

Uses 8-inch hardwound roll towels.

- Constructed of sturdy plastic and designed with an attractive translucent styling for a coordinated washroom appearance.
- Unit made to be wall-mounted.
- Shipping weight: 9 pounds.

NOTE: Use with roll paper.

ITEM NO.	DIMENSIONS	F.O.B. FACTORY EACH
1410 0087	11-3/5" x 10-3/5" x 15-2/5".....	\$87.60

In-Sight® Series-I Toilet Seat Cover Dispenser

- Dispenser minimizes run-out, waste and maintenance time by holding two packs of toilet seat covers.
- Center-located, heavy-duty dispensing lever dispenses one cover at a time.
- Fully enclosed for sanitation purposes.



NOTE: Use with Scott® Personal Seat Covers (Item# 1540 0379). SEE BELOW.



ITEM NO.	DIMENSIONS	F.O.B. FACTORY EACH
1540 9506	17-1/2" x 2-1/4" x 13-1/4".....	\$49.99

Scott® Personal Seat Covers, White

- Flushable covers offer sanitary protection and help reduce litter and clogging.
- Meets EPA guidelines for post consumer waste.



▶ 125 COVERS PER PACK - 24 PACKS PER CASE.

ITEM NO.	SIZE	CASE
1540 0379	15" x 18".....	\$153.09

Metered Spray Deodorizers

- 3,000 metered sprays per 6.5-ounce can.
- Neutralizes and deodorizes.
- Effective on smoke and restroom odors.

NOTE: Use with metered spray dispenser shown on the right.



ITEM NO.	FRAGRANCE
2595 0108	Vanilla
7500 4111	Apple
7500 4112	Fresh Linen
7500 4108	Cinnamon
7500 4109	Wild Flower
7500 4113	Cherry Berry
7500 4120	Mystic Mango
7500 4121	Ocean Mist

▶ 12 CANS PER CASE.

CASE
\$86.97

1/2-Fold Toilet Seat Covers

- Biodegradable covers, safe for all septic tanks.
- Covers will fit most seat cover dispensers.

NOTE: Sold by case only.



▶ 250 COVERS PER BOX - 20 BOXES PER CASE.

ITEM NO.	PRODUCT	CASE
7500 4370	1/2-Fold Toilet Seat Covers . . .	\$66.50

Metered Deodorant Spray Dispenser

- Attractive cabinet.
- Adjustable spray intervals.
- Effective control for up to 6,000 cubic feet.
- Requires two D batteries, not included. ➔

NOTE: Use with spray deodorizers. SEE LEFT.



ITEM NO.	PRODUCT	EACH
7500 4095	Metered Spray Dispenser	\$70.11

Stainless Steel Waste Receptacle

- Type 304 stainless steel with satin finish. • 6-2/5 gallon capacity.
- Surface mounted.
- Heavy-gauge removable liner.
- Bottom edges hemmed for safety.
- Dimensions: 18 inches H x 14 inches W x 6 inches D.

▶ SEE PAGES 256-262
Waste Bins and Trash Cans



ITEM NO.	PRODUCT	EACH
2293 0279	Waste Receptacle	\$150.07

Surpass® Facial Tissue

- Higher tissue count per box than standard tissue boxes.
- Meets EPA guidelines for post consumer waste.
- Tissue size: 7-8/10 inches x 8-3/10 inches.

▶ 100 TISSUES PER BOX - 30 BOXES PER CASE.



ITEM NO.	PRODUCT	CASE
1540 1340	Facial Tissue	\$65.01

Kleenex® Facial Tissue, White

- Premium quality, superior softness, strength and absorbancy.
- Tissue size: 7-8/10 inches x 8-3/10 inches.

▶ 100 TISSUES PER BOX - 36 BOXES PER CASE.



ITEM NO.	PRODUCT	CASE
1540 7606	Kleenex® Tissue	\$91.01

QT Hurricane Ozone Machine

The natural way to eliminate odors in meat lockers, meat markets, food storage areas, processing areas and garbage collection locations.

- No artificial chemicals and deodorizers that mask the smell and leave residue that can cause harm and taint food products.
- Produces ozone which ELIMINATES odors, leaving behind fresh, clean air.
- Accepted by the FDA as safe for direct contact with food.
- Treats area up to 20,000 square feet.
- 110 V. • Portable and quiet.
- Electrical cord length: 7-1/2 foot.
- Dimensions: 13 inches L x 9-1/4 inches W x 11-1/2 inches H.



Programmable Timer Switch — 7-day/6-cycle — deodorizes area up to 20,000 square feet.

ITEM NO.	PRODUCT	EACH
F765 00241	Hurricane Ozone Machine	\$859.00
F765 10461	Replacement Plates	19.95

VERDEdri™ Hand Dryer

High Speed, surface mounted, ADA-compliant hand dryer featuring HEPA filtration system and antimicrobial technology.



- 12 second dry time.
- HEPA filter reduces contaminants in the air while hand drying.
- Energy efficient, adjustable two speed controls to customize drying time, sound level and energy usage.
- Incorporates SteriTouch® antimicrobial technology to inhibit growth of bacteria, mold and fungus.
- Universal voltage — accepts 110- 220/208/ 220-240 VAC input.
- Dimensions: 13-3/10 inches H x 11-3/5 inches W x 3-9/10 inches D.



ITEM NO.	PRODUCT	F.O.B. FACTORY EACH
C313 09741	VERDEdri™, White Aluminum	\$676.95
C313 19731	VERDEdri™, Brushed Stainless Steel	753.95

Plug-In Ozone Machine

Designed to naturally eliminate odors.

- Treats areas up to 500 square feet (20 x 25 foot room).
- Runs 24/7 with less than 4 watts per hour — less than most night lights.
- Weight: > 1 pound. • Plugs into any wall outlet.
- Dimensions: 4 inches W x 6 inches H x 2 inches D.



ITEM NO.	PRODUCT	EACH
F765 10441	Plug-In Ozone Machine.	\$129.95

Hydroxyl Air Treatment Systems

Photo Catalytic Hydroxyl Generator Technology designed to treat the air inside the unit to help eliminate odors and destroy a wide range of bacteria in occupied areas.

- Color: ABS/PC black construction with brushed aluminum body.
- Compact and lightweight. • UVC Germicidal bulb.
- 25,000+ hours of chamber life expectancy. • 24-hour timer options.
- Dimensions and weight:
HG1500 - 13 inches L x 6-1/2 inches W x 8-1/2 inches H; 6 pounds.
HG2500 - 17 inches L x 8-1/5 inches W x 10 inches H; 8 pounds.

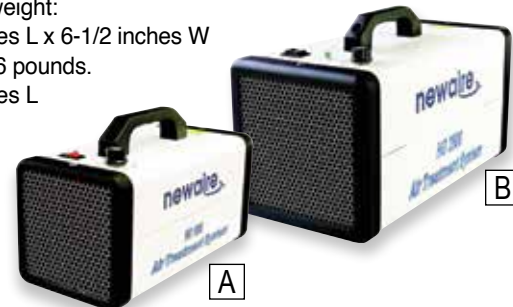

ITEM NO.	PRODUCT	ROOM CAPACITY	FAN VOLUME	EACH
F765 00011	A. HG1500.	1,500 sq. ft.	130 CFM	\$699.99
F765 00021	B. HG2500.	2,500 sq. ft.	212 CFM	899.99

Tampax® Vending Tampons



▶ 500 PER CASE.

ITEM NO.	PRODUCT	CASE
1450 1010	Tampax® Tampons.....	\$135.04

Maxithins® Sanitary Napkins

- 1 folded pad per box.
- Vending box: 3 inches L x 4-1/4 inches H x 1 inch D.



▶ 250 PER CASE.

ITEM NO.	PRODUCT	CASE
1450 0040	Maxithins®.....	\$69.63

Health Gards® Vinyl Urinal Screen

- Cherry scented.
- Odor control for at least 30 days.
- Prevents clogging and fits all urinals.

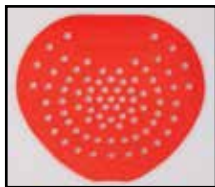

▶ 12 PER CASE.

ITEM NO.	PRODUCT	CASE
1450 3901	Vinyl Urinal Screen.....	\$28.65

Big Foot Door Pull

- Aluminum one-piece construction.
- Easy installation, mounting hardware included.
- Hands-free operation.



ITEM NO.	PRODUCT	EACH
H565 00261	One Size.....	\$34.35

Sanitary Napkin Receptacle

- Tight fitting lid.
- Removable rigid liner is easy to clean.
- Includes five waxed paper bags, see below.

ITEM NO.	PRODUCT	EACH
1770 8842	A. Sanitary Napkin Receptacle.....	\$117.95

Sanitary Disposable Bag

- Waxed bags for sanitary napkin receptacle.
- 8-3/4 inches L x 2-3/4 inches W x 8-1/2 inches D.

▶ 50 BAGS PER BUNDLE - 5 BUNDLES PER CASE.

ITEM NO.	PRODUCT	CASE
1770 8844	B. Sanitary Disposable Bags.....	\$82.55

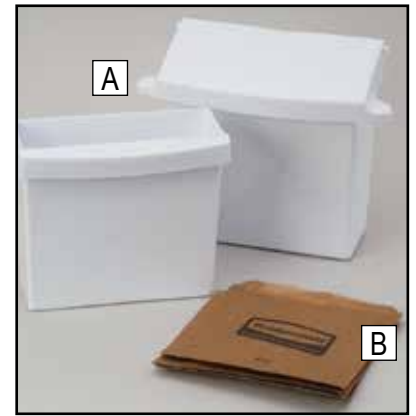

Gards® Maxi Sanitary Napkins

- 1 folded pad per box.
- Vending box: 3 inches L x 4-1/4 inches H x 1-1/8 inches D.



▶ 250 PER CASE.

ITEM NO.	PRODUCT	CASE
1450 2147	Gards®.....	\$73.34



Cherry Toilet Block

- Plastic hanger has a clip that holds block in place even during cleaning.
- Cellophane wrapped block.
- Fights odor up to 30 days.



▶ 12 PER BOX.

ITEM NO.	PRODUCT	BOX
3397 00695	4 oz. Toilet Block.....	\$41.66

Health Gards® Urinal Screen

- Cherry scented.
- Prevents drain clogs.
- Deodorizes up to 30 days.
- Meets CA Prop 65 requirements.



▶ 12 PER CASE.

ITEM NO.	PRODUCT	CASE
1450 0164	Urinal Screen.....	\$43.00

Disposable Urinal Floor Mat

- Backing grips to floor to prevent sliding.
- Contains fungicide and a neutralizing agent to fight germs and odors.

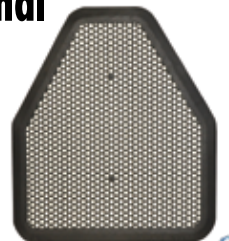

▶ 6 PER BOX.

ITEM NO.	PRODUCT	BOX
6710 0206	Urinal Floor Mat.....	\$81.95

Toilet Bowl Brush

- Brush is stain and odor resistant.
- Length: 14-1/2 inches.
- Durable plastic handle.
- Polypropylene bristles with 1-1/8 inch trim.



NOTE: Brush and holder sold separately.

ITEM NO.	PRODUCT	EACH
1770 63101	Toilet Bowl Brush.....	\$5.45
1770 63111	Brush Holder.....	5.35

Toilet Bowl Plunger

- Designed for toilets and drains.
- Large extended cup for best pressure application.
- 17-inch plastic handle is easy to clean and sanitize.



ITEM NO.	PRODUCT	EACH
6710 01741	Toilet Bowl Plunger.....	\$6.22



ALL ITEMS ON THIS PAGE ARE NON-RETURNABLE CLEANING PRODUCTS



Ultra BluZyme Toilet Bowl Cleaner

- Blue dye lets you know the products are working and indicates when it is time to replace.
- Environmentally Friendly — Naturally occurring bacterium eliminate organic materials that can cause odor and clog drains.
- Saves Time — No excess packaging to dispose of. Just place canister in toilet tank.



▶ 12 PER BOX.

ITEM NO.	PRODUCT	BOX
6710 0030	Ultra BluZyme, 9 oz.	\$49.95

Crew® Neutral NA Bowl and Bathroom Disinfectant

- Non-acid, multi-surface restroom disinfectant cleans, disinfects and deodorizes toilet bowls, urinals, sinks, faucets, walls, countertops and other bathroom surfaces in one easy step.
- Meets OSHA's bloodborne pathogen standard and kills HBV and HIV in one minute.
- Simple ready-to-use flip top bottle.



▶ 12 PER CASE.

ITEM NO.	PRODUCT	CASE
1520 1250	Crew, 1 qt.	\$64.95

Clorox® Toilet Bowl Cleaner with Bleach

- Kills toilet bowl germs.
- Removes tough rust and hard water stains while deodorizing with a fresh, clean scent.
- Coats toilet bowl to dissolve dirt and grime.



▶ 12 PER CASE.

ITEM NO.	PRODUCT	CASE
3838 9031	Clorox Cleaner, 24 oz.	\$367.31

Creme Cleanser

- Mild abrasive for tough cleaning jobs.
- Cleans and deodorizes.



▶ 12 PER CASE.

ITEM NO.	PRODUCT	CASE
6129 6710	Creme Cleanser, 1 qt.	\$93.94

Sargent® Toilet Bowl Cleaner

Ready to use.
No mixing required.

- High acid disinfectant toilet bowl cleaner with organic soil tolerance.



▶ 12 PER CASE.

ITEM NO.	PRODUCT	CASE
6129 6683	Sargent, 1 qt.	\$93.86

Emerel™ Multi-Surface Cleanser

- Use to scour tough stains and soils on sinks, toilet bowls, ceramic tiles, pots and pans.
- Off-white creme cleanser cleans without scratching.
- No mixing necessary, ready to use.



▶ 12 PER CASE.

ITEM NO.	PRODUCT	CASE
1520 0755	Emerel, 1 qt.	\$78.95

Liquid Comet with Bleach Cleanser

- Ready to use cleanser, bleaches tough stains.
- Solvents cut through grease and other soils.



▶ 8 PER CASE.

ITEM NO.	PRODUCT	CASE
1690 7017	Liquid Comet, 32 oz.	\$114.49

Comet Cleanser

- Bleaches out tough stains and removes soap scum.
- EPA registered disinfectants wipe out salmonella, staph and other germs.



▶ 24 PER CASE.

ITEM NO.	PRODUCT	CASE
1690 2987	Comet, 21 oz.	\$156.17

NEED ASSISTANCE?



Our experienced customer service representatives are available to answer your questions, find the products you are looking for, check product availability, as well as take your order.

800-456-5624



Food-Approved Drums
with **Optional Snap Down Lids**
and **Round Twist-On Dollies**

▶ SEE PAGES 257, 258 & 260

MATERIAL HANDLING

FIND IT FAST

Totes and Tote Dollies	188-201
ToteAll 2000® Molded Poly Boxes	188-189
Mega-Totes and Bulk Tubs and Dollies	198-199
ChillTotes™ and Freezer Baskets	200-201
Platters and Platter Dollies	202-205
Steamer Pans	204
Food Boxes, Dough Boxes and Dollies	206-207
Ingredient Bins	208-209
Utility Carts	210-211
Stock, Platform and Hand Trucks	212-215
Tilt Trucks	216-217
Combo Bins, Vats, Storage and Laundry Trucks	218-219
Collapsible Bins	220-221
Combo Caps, Liners, Bands and Cooler Ramp	222
Freezer Spacers, Slipsheets, Pallets and Movers	223-225
Ergo Stands and Dunnage Racks	226-227
Shelving and Storage Cabinets	228-230
Stainless Steel Buggies and Trucks	231-232
Receiving Desk	233
Work Tables	234-236
Table Tops and Cutting Boards	237
Wheels and Casters	238-241
Scrapers, Food Hoe, Shovels, Spades and Forks	242-247
Scrapers, Scoops and Food Containers	248-253
Buckets, Pails, Lids, Process Drum and Jugs	254-256
Drums, Dollies, Trash Cans, Liners and Accessories	256-263





ToteAll 2000® Molded Poly Boxes

• Max temp: 410 °F/210 °C.

50 Pound Capacity
Weighs only 3.8 pounds empty
1.3 cubic feet

90° cross stacking
via stacking grooves
built into bottom of tote.



Smooth interior and wide radius corners for easy cleaning.

Stacking grooves allows cross stacking.

Molded-in handles.

Reinforced nesting-stops prevent jamming.



Finely etched exterior resists cuts and scratches.

Wall thickness: 1/8"

All Colors Are FOOD APPROVED!

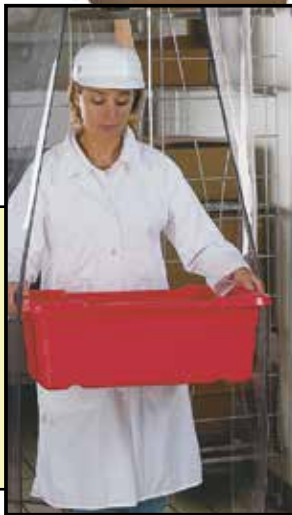

TOTE DIMENSIONS

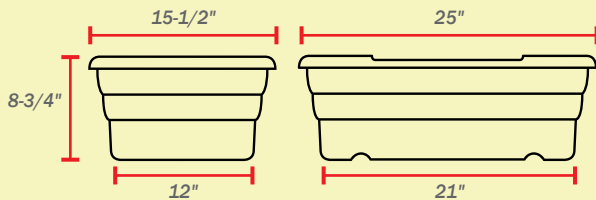

4:1 nesting ratio saves space.

ITEM NO.	COLOR
3195 06641	Orange
3195 2013	Tan
3195 46331	Yellow
3195 46351	Green
3195 46341	Blue
3195 00021	Purple
3195 46321	Red
3195 73041	Pink
3195 07071	White
3195 06621	Gray
3195 46361	Black

▶ 100 PER PALLET.

EACH

\$13.95

OUR TOTEALL 2000® POLY BOXES are a first-class product with ribs along the bottom lifting ledge to increase the strength of the ledge when it's used in tote dollies. These reinforcements make our first-class tote a level above our competitors.

ToteAll 2000® Poly Box Lids



ITEM NO.	PRODUCT	EACH
3195 73211	Lid, White.....	\$11.95
3195 59001	Lid, Gray.....	11.95

Economy Blemished Tote

- Resists cuts and scratches. • Cross stack and nestable.
- Easy to handle grips. • NOT food approved.
- Color: multi-colored. • Some may have imprinting.
- ToteAll 2000® lids (shown above) will fit these non-food totes.
- Dimensions:
13 inches x 8-1/2 inches ID;
15-1/2 inches x 25 inches x 8-3/4 inches OD.



NOTE: Lids sold separately. SEE ABOVE.

ITEM NO.	PRODUCT	EACH
3195 57761	Economy Blemished Tote.....	\$12.15

Poly Tote Liners



Clean-ups have never been easier! Liners are approved for food contact.

- Liners eliminate the need for cleaning totes — just pull off the used liner and throw away!
- Blue, 1.5 mil polyethylene liners fit all ToteAll 2000® totes.



CALL to request a FREE SAMPLE!

▶ 500 PER CASE.

ITEM NO.	PRODUCT	DIMENSIONS	CASE
E179 2215	Blue Tote Liners.....	22" x 15" x 20".....	\$181.98

ToteAll 2000® Imprinted Poly Boxes



- Our same famous poly boxes imprinted with "Edible" or "Inedible" verbiage.
- Dimensions:
13 inches x 22 inches x 8-1/2 inches ID;
15-1/2 inches x 25 inches x 8-3/4 inches OD.



ITEM NO.	PRODUCT
3195 01271	White, "Edible"
3195 01281	Grey, "Inedible"
3195 01291	Red, "Inedible"
3195 58761	Yellow, "Inedible"

▶ 100 PER PALLET.

EACH \$18.95



▶ SEE PAGE 206

FOR ADDITIONAL FOOD BOXES

Jumbo Poly Totes



- Injection molded will handle large quantities of product.
- Rugged, high-density polyethylene.
- Stainless steel bails form base for stacking.
- Capacity: 100 pounds. • Color: gray. • Weight: 9 pounds.



ITEM NO.	PRODUCT	DIMENSIONS	EACH
1695 0655	Tote w/o Bails	16-9/10" x 34-1/2" x 9-9/10"	\$164.18
1695 0653	Tote w/Bails	16-9/10" x 34-1/2" x 9-9/10"	154.42

Aluminum Tote



- Sturdy and light-weight. • Nest when not in use.
- Constructed of seamless aluminum alloy with an anodized finish.
- Capacity: 1.9 cubic feet; 75 pounds.
- Weight: 5 pounds.



ITEM NO.	PRODUCT	DIMENSIONS	EACH
1695 90371	Tote	26" x 15-1/2" x 8"	\$112.65
1695 0072	Lid	26" x 16" x 1"	63.25

Distribution Totes

The only tote accepted by many retail food operations.

- Complies with sanitation and material handling requirements of many retail food processors.
- Sturdy design has reinforced ribs and deep molded hand grips for convenient lifting and carrying.
- For use in refrigerated trailers, freezers and walk-in storage coolers.
- Withstand temperatures from -20 °F to 120 °F.
- Cross-stack and interlock on a 40 inch x 48 inch pallet.
- Stack with optional covers, nest when empty.
- Made of injection-molded polyethylene.
- FDA compliant.
- Color: beige.



ITEM NO.	PRODUCT	DIMENSIONS	WEIGHT	CAPACITY	EACH
1814 41681	Tote, Standard Size	.24" x 16" x 8.7"	3-3/4 lb	40 lb	\$24.95
1814 07681	Tote, Large Size	.24" x 16" x 10-3/4"	5 lb	55-60 lb	26.95
1814 07701	Lid, Standard Size	.24" x 16" x 1-1/2"	2-1/5 lb		14.37
1814 9014	Lid, Large Size	.24.3" x 16.3" x 1-4/5"	4 lb		17.95

Aluminum Tote Dolly

For use in moving and storing chicken boxes.

- One side of dolly is open for easy placement and removal of chicken boxes.
- Corners are open for easy cleaning.
- Equipped with four, 3-inch swivel casters.
- Strong and durable aluminum will not rust.
- Shipping weight: 12 pounds.



ITEM NO.	PRODUCT	DIMENSIONS	EACH
3775 6223	Aluminum Tote Dolly	23" x 16" x 6"	\$143.05

Tote with Hinged Lids

- Containers stack when closed or nest when open to provide efficient use of space.
- Heavily reinforced hinge elements reduce breaking and cracking.
- Pebble-grain bottom surface provides excellent conveyor traction.
- Cover recessed within the perimeter of container to protect against cover breakage while conveyed or shipped.
- Molded-in security tie holes.

Security holes are compatible with a variety of tote closures, from ties to padlocks.



GRAY ITEM NO.	BLUE ITEM NO.	OUTSIDE BASE DIMENSIONS	OUTSIDE TOP DIMENSIONS	HEIGHT	EACH
1814 11431	1814 11441	19-1/10" x 13-3/10"	21-9/10" x 15-1/5"	9"	\$25.36
1814 11821	1814 11831	18-3/5" x 12-9/10"	21-9/10" x 15-1/5"	12-9/10"	26.30
1814 12441	1814 12431	24-2/5" x 14-7/10"	26-9/10" x 12-9/10"	12-1/10"	28.95
1814 14021	1814 14031	25-4/5" x 18"	27-9/10" x 20-9/10"	15-1/5"	49.95

Transport Storage Tub

Approved for direct food contact.

- Meets all USDA specifications and can be used for meat, seafood, poultry, fishing, confectionery, bakery and grain applications.
- Tubs can be used as stand-alone items or with low steel undercarriages.
- Tub Dimensions: 46-1/2 inches L x 26 inches W x 16-1/5 inches H.
- Manufactured from high-density polyethylene.
- Can be used for transporting, freezing and storing.
- Snap tight lid keeps contents secure during transport.
- Capacity: 500 pounds, 8-Bushel.
- Color: white.

NOTE: Tub, lid and undercarriage all sold separately.



Remco
a Vikon company

ITEM NO.	PRODUCT	EACH
5281 0283	A. Tub	\$383.67
5281 02781	B. Lid	199.23
5281 6913	C. Steel Undercarriage	618.15

Super-Duty Brute® Totes with Lids

Approved for direct food contact.

- NSF Standard #2 commercial grade material withstands heavy-duty use.
- Ergonomic grip handles provide greater mobility.
- Handles have drain holes to reduce the risk of bacteria build up.
- Snap-tight lid keeps contents secure during transport.
- Reinforced rib constructed bottom allows product to be dragged.
- Stacks for efficient use of space.

14 gallon capacity:
400 pounds.

20 gallon capacity:
500 pounds.



▶ 6 PER CASE.

ITEM NO.	PRODUCT	DIMENSIONS	EACH
1770 30001	14 Gallon, Gray	27.9" x 17-2/5" x 10.7"	\$48.15
1770 30011	14 Gallon, White	27.9" x 17-2/5" x 10.7"	48.15
1770 31001	20 Gallon, Gray	27.9" x 17-2/5" x 15.1"	53.45
1770 31011	20 Gallon, White	27.9" x 17-2/5" x 15.1"	53.45



Palletote™ Shipping Containers

180° stack/nest shipping boxes.

- Durable, reusable boxes are ideal for shipping and many in-process material handling jobs.
- Made with USDA 3A (dairy) Sanitary Standards and Meat and Poultry Equipment Group Listed.
- Materials are FDA-compliant for food contact and certified to NSF 2 Standards.
- Injection-molded polyethylene for uniform wall thickness.
- Nestable or stack with lids.
- Recommended operating temp: -10 °F to 130 °F.
- Easy to clean.
- Color: gray.

Standard box: OD fits 6-up on 40 x 48 inch pallet.
Large box: OD fits 4-up on 40 x 48 inch pallet.



▶ 10 PER CASE.

ITEM NO.	PRODUCT	DIMENSIONS	EACH
1770 73241	Standard Box	19-1/2" x 15-1/2" x 10"	\$29.55
1770 47061	Standard Lid		27.75
1770 73301	Large Box	23-1/2" x 19-1/2" x 10"	37.85
1770 73281	Large Lid		30.95

Comfort Curve™ Color-Coded Tote Boxes

- Comfort Curve™ handles for a sure, comfortable grip.
- Reinforced rims reduce bending, bowing and breaking.
- Contour lid design allows easy box-on-box stacking.
- Available in different colors for HACCP zone use.
- NSF Std 2 – meets the criteria for food contact and cleanability.
- Molded polyethylene construction withstands temperatures from 32 °F to 180 °F.
- Tote dimensions: 20 inches L x 15 inches W x 5 inches D.
- Lid dimensions: 20 inches L x 15 inches W x 1 inch D.



Totes

ITEM NO.	COLOR
6387 13621	Yellow
6387 13581	Blue
6387 13641	Black
6387 13661	Gray
6387 13631	White

▶ 12 PER CASE.

EACH
\$16.94

Lids

ITEM NO.	COLOR
6387 13781	Yellow
6387 13691	Blue
6387 13731	Black
6387 13741	Gray
6387 13751	White

▶ 12 PER CASE.

EACH
\$13.81

11-Quart Food Box Mini Tote

Rounded corners for easy cleaning.

- Made of durable, commercial grade plastic, reinforced bottom and ribs for added strength.
- Nestable containers stack securely for efficient use of space.
- Commercial dishwasher safe.
- Food-approved. • Color: white.



▶ 6 PER CASE.

ITEM NO.	PRODUCT	DIMENSIONS	EACH
1770 36901	Tote Box, White	14-3/8" x 12-3/8" x 5-3/8"	\$21.55

Molded Poly Totes

- Food usage USDA 3-A and NSF 2 certified.
- Made of molded polyethylene.
- Resist cuts and scratches.
- Easy to handle grips.
- Colors: white or gray.
- Capacity: 4-5/8 gallons.
- Nestable.
- OD Dimensions: 20 inches L x 15 inches W x 5 inches D.



▶ 10 PER PALLET.

ITEM NO.	COLOR
1770 07291	White
1770 79501	Gray

EACH
\$13.85



NOTE: Totes sold separately.



Aluminum Bus Cart

Push design for various mobile tasks such as serving, bussing and general utility.

- Three shelf units have three edge lips up and one lip down to help hold products on shelves.
- Frame constructed of 1-inch x 1-inch x 0.070-inch wall tubing.
- Shelves are aluminum sheet, 24 inches L x 16-1/2 inches W x 0.080 inch thick.
- Included four 5-inch stem-type swivel casters.
- Dimensions: 27-3/4 inches L x 16-1/2 inches W x 39 inches H.

ITEM NO.	PRODUCT	EACH
3775 0026	Aluminum Bus Cart	\$518.61

ToteAll 2000®



► SEE PAGE 188
Totes Sold Separately

Heavy-Duty Welded Aluminum Merchandising/Picking Cart

Display your promotional merchandise on this mobile cart or use it as a mobile picking cart.

- Designed to hold up to nine totes at an 18° angle for an eye-catching display.
- Construction:
Framework: 1-1/2 inch x 1-3/4 inch wall tubing.
Shelves: 1-1/4 inch x 2-1/4 inch wall T-Bar.
Lug stops: 1 inch x 1 inch x 0.094 inch wall tubing.
- All-welded aluminum construction, will never rust.
- 5-inch platform casters, 2 swivel and 2 rigid.
- Shelf size: 50 inches L x 20-5/16 inches W.
- Overall size: 53 inches L x 22 inches W x 65-1/2 inches H.



ITEM NO.	PRODUCT	CASTERS	CAPACITY	EACH
3775 1230	Merchandising/Picking Cart	.2C and 2D	1,000 lb	\$1,208.24

Heavy-Duty Welded Aluminum 18+ Tote Dolly

- Each dolly has the capacity to hold up to 50 pounds of product per tote.
- Made of heavy-duty 1-1/4 inch x 1-1/2 inch D-shaped tube hoop frame.
- All welded aluminum dollies hold 16 inch W x 25 inch L x 8-1/2 inch H totes.
- All dolly seams are welded and sealed.
- Four: 5-inch platform casters, 2 swivel and 2 rigid.
- Overall Size: 54-1/8 inches L x 26-1/2 inches W x 72-5/8 inches H.

NOTE: Not recommended with full totes on top row.



D-shaped aluminum tube.

► SEE PAGE 188
Totes Sold Separately

► SEE PAGES 238-241
Replacement Caster Options



ITEM NO.	PRODUCT	CASTERS	CAPACITY	EACH
3775 0025	Aluminum 18+ Tote Dolly	.2C and 2D	1,000 lb	\$1,279.16

Heavy-Duty Welded Aluminum 24+ Tote Dolly

- All welded aluminum dollies hold 16 inch W x 25 inch L x 8-1/2 inch H totes.
- Each dolly has the capacity to hold up to 50 pounds of product per tote.
- Made of heavy-duty 1-1/4-inch x 1-1/2-inch D-shaped tube hoop frame.
- All dolly seams are welded and sealed.
- Four: 5-inch platform casters, 2 swivel and 2 rigid.
- Overall Size: 50 inches L x 36-1/2 inches W x 72-5/8 inches H.

NOTE: Not recommended with full totes on top row.

► SEE PAGE 188
Totes Sold Separately



D-shaped aluminum tube.



► SEE PAGES 238-241
Replacement Caster Options

ITEM NO.	PRODUCT	CASTERS	CAPACITY	EACH
3775 0034	Aluminum 24+ Tote Dolly	.2C and 2D	1,000 lb	\$1,901.69

Standard-Duty Welded Aluminum Tote Dollies

- Standard dollies are made of 1 inch square tube frame with 1 inch square tube cross supports.
- All welded aluminum dollies accept 16 inch x 25 inch x 8-1/2 inch high totes.
- Each dolly has the capacity to hold up to 50 pounds of product per tote.
- Four swivel stem casters with 5 inch black polyolefin wheels, 2 with brakes.
- All dolly seams are welded and sealed.

ToteAll 2000®



A



B



D



C



E

► SEE PAGE 188
Totes Sold Separately

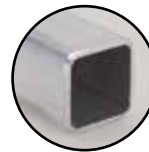

All sizes are made of square tube frames and supports.

ITEM NO.	PRODUCT	CASTERS	DIMENSIONS	EACH
3775 6265	A. Single Tote Dolly	2A and 2B	16" x 26" x 19"	\$151.95
3775 0511	B. Double-Stacked Tote Dolly	2A and 2B	15-3/4" x 28-1/4" x 33"	221.17
3775 9316	C. Side-by-Side Double Tote Dolly	2A and 2B	32-1/2" x 26" x 19"	228.48
3775 6262	D. Four Tote Dolly	2A and 2B	18.9" x 26" x 51"	299.40
3775 6264	E. Six Tote Dolly	2A and 2B	18.9" x 26" x 71"	384.83

Standard-Duty 5" Replacement Stem Casters

Capacity: 135 pounds per wheel.

- Fits all Standard-Duty Dollies shown on this page.
- 7/16-inch stem.
- Width: 1 inch.
- Black polyolefin wheels.
- Standard-Duty Dollies require 2A and 2B casters.

ITEM NO.	PRODUCT	EACH
0844 4202	A. Swivel, w/Brake	\$20.31
0844 4201	B. Swivel, w/o Brake	16.65

► SEE PAGES 238-241
For More Caster Options



A



B

Heavy-Duty 5-Inch Replacement Casters

Capacity: 250 pounds per wheel.

- Fits all Heavy-Duty Welded Dollies shown on this page.
- Width: 1-3/8 inches.
- Single, double and triple tote dollies are equipped with four, 5-inch swivel stem casters, 2 with brakes.
- Six, seven and ten tote dollies are equipped with four, 5-inch plate casters, 2 swivel and 2 rigid.

ITEM NO.	PRODUCT	EACH
0844 22191	A. 5" Caster, Stem Swivel, No Brake	\$19.65
0844 22201	B. 5" Caster, Stem Swivel, With Brake	23.79
0844 22181	C. 5" Caster, Plate Rigid	18.12
0844 22171	D. 5" Caster, Plate Swivel, With Brake	29.79



A



B



C



D

Heavy-Duty Welded Aluminum Tote Dollies

- Single, double and triple tote dollies are made of heavy-duty 1-1/4-inch square tube hoop frame.
- All dolly seams are welded and sealed.
- All welded aluminum dollies hold 16 inch W x 25 inch L x 8-1/2 inch H totes.
- Each dolly has the capacity to hold up to 50 pounds of product per tote.
- Six, seven, nine and ten tote dollies are made of heavy-duty 1-1/4 inch x 1-1/2 inch D-shaped tube hoop frame.



HEAVY-DUTY WELDED ALUMINUM TOTE DOLLIES



Ergonomic handle.

ITEM NO.	PRODUCT	CASTERS	DIMENSIONS	EACH
3775 9317	A. Single Tote Dolly	2A and 2B . . .	16-1/4" x 26" x 19"	\$253.50
3775 9318	B. Double-Stacked Tote Dolly	2A and 2B . . .	16-1/4" x 28-1/4" x 33"	297.28
3775 9319	C. Side-by-Side Double Tote Dolly	2A and 2B . . .	33" x 26" x 19"	292.83
3775 9304	D. Three Tote Dolly	2A and 2B . . .	16" x 29" x 42-1/2"	390.03
3775 3797	E. Side-by-Side Six Tote Dolly	2C and 2D . . .	29-3/4" x 20-3/4" x 38"	497.62
3775 2535	F. Six+ Tote Dolly	2C and 2D . . .	18-3/4" x 26-1/2" x 72"	495.29
3775 4198	G. Side-by-Side Ten Tote Dolly	2C and 2D . . .	29-1/2" x 31-1/2" x 61"	555.49
3775 0093	H. Nine Tote Dolly w/Ergo Handle*		24" x 42-7/8" x 51"	1,357.66

*Call your CSR for replacement caster options.

HEAVY-DUTY DOLLY TUBING INFO

HEAVY-DUTY DOLLIES USE 1" SQUARE TUBE CROSS-SUPPORTS



Square Tubing
1-1/4" x 1-1/4" x 0.10"

A, B, C and D
have square
tubing frame.



D-Shaped Tubing
1-1/4" x 1-1/2" x 0.08"

E, F, G and H
have D-shaped
tubing frame.

Stainless Steel Knock-Down Tote Dollies

- All stainless steel.
- Equipped with 4 swivel casters.



Quick and easy assembly using eight standard 1/4-inch bolts (supplied).



Angled ridge helps to center the tote.

► SEE PAGE 188
Totes Sold Separately



► SEE PAGES 238-241
For More Caster Options



ITEM NO.	PRODUCT	DIMENSIONS	EACH
2990 2936	A. Double Tote Dolly	25-1/2" x 18-2/5" x 30"	\$628.90
2990 2937	B. Four Tote Dolly	25-1/2" x 18-2/5" x 50"	772.75
2990 2938	C. Six Tote Dolly	25-1/2" x 18-2/5" x 70"	933.50

SHOP 24/7

bunzlpd.com



Need Help?
Chat With Us
Online!

STAY CONNECTED WITH US:



Where you can find out what's on sale, find updated product information, reviews and pricing.



Heavy-Duty Aluminum 6+ Tote Knock-Down Dolly

- Constructed of 1-1/4-inch square aluminum tubing.
- Knocks-down for convenient UPS shipping.
- 5-inch x 1-3/8-inch heavy-duty, swivel stem casters, 2 with brakes. Replacement casters available.
- Easy assembly. • Shipping weight: 34 pounds.
- Capacity: 300 pounds or 6, 50-pound totes.



Top row tote storage



ITEM NO.	PRODUCT	DIMENSIONS	EACH
3775 6263	Six Tote, Vertical Dolly.	19" x 26" x 71"	\$412.29
0844 22191	Replacement Swivel Caster		19.65
0844 22201	Replacement Swivel Caster w/Brake		23.79

Aluminum Empty Tote Dolly

- Transfer up to 25 empty totes.
- Able to cross stack totes.
- Equipped with 4 swivel casters for greater mobility.



► SEE PAGE 188
Totes Sold Separately

ITEM NO.	PRODUCT	DIMENSIONS	EACH
3775 7326	Empty Tote Dolly26" x 17" x 6"	\$160.22
3775 04101	Replacement Casters		45.95

Aluminum Knock Down Table with Poly Top

- Made with heavy-duty aluminum frame. • Includes four non-locking 4-inch casters.
- Includes 1 gray, 50-pound capacity poly tote.
- Available with or without 6-inch backsplash.

► SEE PAGE 188
Additional Tote Colors Available

► SEE PAGE 238
Locking Casters Available

NOTE: 50 pound capacity tote INCLUDED!

Tote slides easily on built-in slide rails.



F.O.B. FACTORY
EACH

ITEM NO.	PRODUCT	DIMENSIONS	F.O.B. FACTORY EACH
2510 3501	Poly Top Table w/Tote.30" x 24" x 34"	\$573.65
2510 3502	Poly Top Table w/Tote and 6" Backsplash		759.95



Optional backsplash.

Mega-Totes and Dollies



- FDA-compliant, removable polyethylene totes hold up to 66 gallons (9 bushels). • Color: natural.
- Heavy-duty, 250 pound capacity, 5-inch x 1-3/8-inch swivel stem casters roll smoothly over varying surfaces.
- 4-bushel tote: 30 gallon capacity; 6-bushel tote: 41 gallon capacity; 8-bushel tote: 57 gallon capacity; 9-bushel tote: 66 gallon capacity.
- All-welded aluminum dolly will not rust. • Optional shoebox type lids available. • Height: 36 inches without lid, 36-1/2 inches with lid.



Scan this QR code with your mobile device to view a video of the features of this Mega Tote.



ITEM NO.	PRODUCT	TOP DIMENSIONS	BOTTOM DIMENSIONS	SHIPPING WT.	EACH
4743 2204	A. 4-Bushel Mega-Tote	21-1/4" x 32-3/4" x 15-3/4"	24-3/4" x 15"	12 lb.	\$229.85
4743 2214	4-Bushel Mega-Tote Lid	22-1/2" x 34"		5 lb.	95.93
3775 1104	4-Bushel Mega-Tote Dolly	20-1/2" x 30-1/4" x 30-1/2"		13 lb.	333.00
4743 2206	B. 6-Bushel Mega-Tote	23-1/4" x 32-1/4" x 20"	23-1/2" x 16"	13 lb.	241.95
4743 2216	6-Bushel Mega-Tote Lid	24-1/2" x 33-1/2"		6 lb.	161.43
3775 0019	6-Bushel Mega-Tote Dolly	23" x 28" x 26"		22 lb.	332.26
4743 2108	C. 8-Bushel Mega-Tote	24-1/4" x 36-1/4" x 23"	28-1/2" x 17"	23 lb.	254.05
4743 2218	8-Bushel Mega-Tote Lid	25" x 37-1/2"		9 lb.	203.89
3775 0018	8-Bushel Mega-Tote Dolly	24" x 34" x 23"		18 lb.	340.21
4743 2009	D. 9-Bushel Mega-Tote	29-1/2" x 41-1/2" x 19"	33" x 21"	25 lb.	314.55
4743 2219	9-Bushel Mega-Tote Lid	30" x 43"		12 lb.	216.10
3775 1019	9-Bushel Mega-Tote Dolly	27" x 37-1/2" x 27"		24 lb.	368.93
0844 22191	Replacement 5" Swivel Stem Casters (250 lb Capacity)				19.65

Bulk Tubs and Dollies

Food approved tubs are ideal for processing areas.

- 14-bushel tub: 105 gallon capacity; 16-bushel tub: 120 gallon capacity; 18-bushel tub: 135 gallon capacity; 20-bushel tub: 150 gallon capacity.
- All aluminum base will never rust. • FDA compliant tubs are white.



Seamless molded polyethylene interior with rounded corners, resists cuts/scratches.

Aluminum dolly features heavy-duty polyolefin/polyurethane plate casters – 2 rigid and 4 swivel allowing for zero degree turning. Rated for 1,500 pounds.



ITEM NO.	PRODUCT	TOP DIMENSIONS	BOTTOM DIMENSIONS	SHIPPING WT.	EACH
4743 2014	A. 14-Bushel Tub.	43-3/4" x 31-3/4" x 28-1/2"	35-1/2" x 15"	28 lb.	\$447.65
3775 0005	14-Bushel Dolly	27-3/4" x 39-1/2" x 9"		30 lb.	479.28
4743 2016	B. 16-Bushel Tub.	45" x 31" x 29-1/2"	36" x 23"	31 lb.	508.15
3775 0006	16-Bushel Dolly	26-3/4" x 40-1/4" x 9"		30 lb.	577.75
4743 2018	C. 18-Bushel Tub.	46-1/4" x 34" x 31"	38" x 25-1/2"	41 lb.	628.04
3775 0007	18-Bushel Dolly	30-1/4" x 42-3/4" x 9"		31 lb.	550.19
4743 1020	D. 20-Bushel Tub.	46" x 34" x 32-1/2"	37" x 25"	48 lb.	665.45
3775 0008	20-Bushel Dolly	29-1/4" x 40-3/4" x 9"		33 lb.	581.68

WHY CALL FOR PRICING? With product availability and costs fluctuating due to supply chain sourcing, you will see certain products displayed without a price in this Buyers Guide and instead are listed as Call for Pricing. On such items, please call our Customer Service team at 800-456-5624 or visit our website at www.bunzlpd.com where pricing is always up to date.

ChillTote™ Trays

- ChillTotes™ fit four-up on standard 42-inch x 48-inch pallets.
- Light-weight freezer proof, stackable/nestable and easy to clean.
- Flow-thru basket design allows maximum air circulation for faster, more efficient freezing.
- Heavy ribs on bottoms of trays prevent the contents of upper and lower trays from freezing together.
- Injection molded from high-density polyethylene to withstand constant freezer temperatures without cracking or warping.
- Capacity: Standard: 1.4 cubic feet, 50 pounds.; Deep: 2.9 cubic feet, 75 pounds.



Two 3/8 inch zinc-plated steel wire bails swing down to allow nesting and swing up for stacking.

NOTE: Maximize your freezer space and eliminate basket shelving by using ChillTote™ aluminum transport dollies. SEE BELOW.

Cuts Conventional Freezing Time IN HALF!

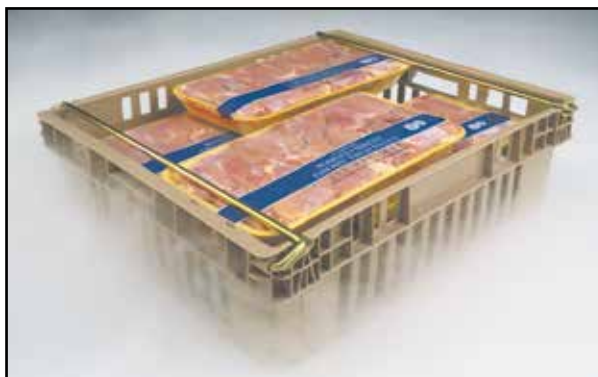

MAXIMUM AIR CIRCULATION.

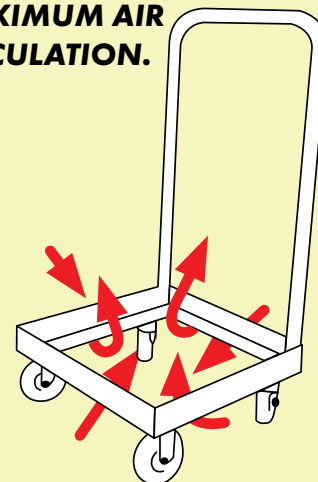

ITEM NO.	PRODUCT	DIMENSIONS	CAPACITY	EACH
1814 28631	Standard Chilltote™	22" x 19" x 6"	50 lb.	\$30.61
1814 58901	Deep Chilltote™	24" x 20" x 13"	75 lb.	52.91

Heavy-Duty ChillTote™ Dollies

- Heavy-duty aluminum dollies make a portable chill system.
- Two swivel and two rigid casters with durable 5-inch heavy-duty wheels. Uses 2F and 2G casters.
- Load capacity: 750 pounds.

NOTE: Handle and ChillTote™ trays sold separately.



ITEM NO.	PRODUCT	DIMENSIONS	SHIPPING WT.	EACH
3775 2860	A. Single	22-1/4" x 22-1/2" x 8-1/2"	14 lb.	\$263.89
3775 2861	B. Double	22-1/4" x 42-1/2" x 8-1/2"	20 lb.	280.95
3775 4527	C. Triple	22-1/2" x 63" x 8-1/2"	22 lb.	363.74
3775 2862	Optional 35" Handle			59.10

ChillTote™ Dollies

- For use in moving and storing ChillTotes™. • Open corners for easy cleaning. • Will not rust.
- Strong, durable aluminum construction with four 3-inch swivel casters.

NOTE: ChillTote™ trays sold separately. SEE ABOVE.



► SEE PAGE 240 For Replacement Casters



ITEM NO.	PRODUCT	DIMENSIONS	SHIPPING WT.	EACH
3775 9322	Dolly	23-1/2" x 19" x 6"	15 lb.	\$143.05

Freezer Totes

Heavy-duty poly food boxes won't warp, split or crack when frozen.

- Molded bottom ridges. • Pebble finish exterior.
- Wide radius corners and a smooth finish for easy cleaning.
- Optional standard tote reinforced lid for stacking.
- Temperature range: -60 °F (blast freeze) to 170 °F.
- Color: white.



Our FREEZER TOTE SPREADER is ideal for stacking and palletizing freezer totes.

**ITEM# 3502 53441
CALL FOR DETAILS**

A. Standard Freezer Totes

OD: 21-1/4 inches L x 15-3/4 inches W

ITEM NO.	PRODUCT	EACH
6604 47761	5" Deep	\$35.75
6604 47771	7" Deep	36.55
6604 47781	Lid	18.90



B. Large Freezer Totes

OD: 25 inches L x 16 inches W x 8-1/2 inches H

ITEM NO.	PRODUCT	EACH
3502 58951	8-1/2" Deep	\$39.95

Universal Freezer Basket Dollies

- Two plate swivel and two plate rigid 5-inch casters with heavy-duty wheels.
- Dollies accept freezer baskets shown right (sold separately).
- Welded aluminum construction with no crevices to trap bacteria.
- Replacement casters available. Uses 2F and 2G casters.



Easy slide angles have built-in stops to prevent freezer baskets from sliding all the way out.



All-Purpose Freezer Baskets

Heavy, chrome-plated, welded steel wire construction.

- Designed to fit our standard basket dollies.
- Ideal for freezing or cooling product.
- Nest when empty to save space.
- Dimensions: 28 inches L x 17 inches W.

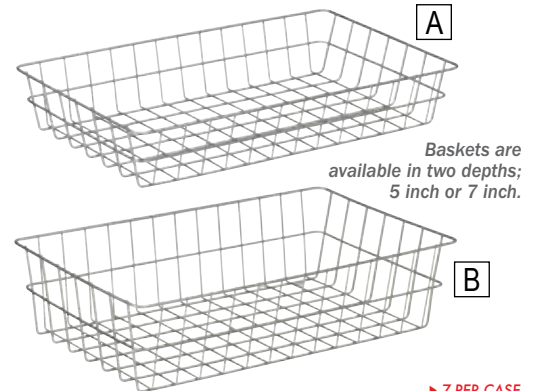

ITEM NO.	PRODUCT	EACH
3056 0722	A. 5" Deep	\$51.09
3056 4326	B. 7" Deep	52.95

▶ 7 PER CASE.

ITEM NO.	PRODUCT	DIMENSIONS	CAPACITY	EACH
3775 2130	7-Basket Dolly	29" x 20" x 61"	500 lb.	\$669.76
3775 1272	8-Basket Dolly	29" x 20" x 68-3/5"	500 lb.	696.05
3775 1273	9-Basket Dolly	29" x 20" x 76-2/5"	500 lb.	752.55
3775 4325	12-Basket Dolly	35-1/2" x 31-1/2" x 61-2/5"	500 lb.	710.36

▶ SEE PAGE 496

FOR FREEZER AND LOCKER PAPERS

Aluminum Platter Dollies



10-Platter Dolly

- Constructed of 1-inch square welded aluminum tubing.
- Spacing: 4-3/4 inches apart.
- Holds ten, 18-inch x 26-inch platters.
- Four, 5-inch swivel casters, two with brakes.



NOTE: Platters sold separately. SEE RIGHT.

Heavy-Duty 12-Platter Dolly

- Spacing: 5 inches apart.
- Four, 5-inch swivel casters.



20-Platter Dollies

- Stations are spaced 2-7/8 inches apart. Side load (C) or end load (D).
- Four, 5-inch swivel casters, two with brakes.
- Holds 20, 18-inch x 26-inch platters.



ITEM NO.	PRODUCT	DIMENSIONS	CAPACITY	EACH
3775 8394	A. 10-Platter Dolly	.20" x 28-1/2" x 58"	300 lb.	\$514.90
3775 3003	B. 12-Platter Dolly	.21-1/4" x 26-3/4" x 69-1/4"	500 lb.	541.08
3775 1332	C. 20-Platter, Side Load	.28" x 20-1/4" x 69-1/2"	500 lb.	568.53
3775 1331	D. 20-Platter, End Load	.28-1/2" x 20-1/4" x 69-1/2"	500 lb.	568.53

Aluminum Slant Display 7-Platter Dolly



Provides an attractive display with high product visibility.

- Designed to hold up to seven, 18-inch x 26-inch platters. Six slanted for display and one on the bottom base.
- Framework is made of 1-inch square wall tubing with all welded 1-5/8 inch angle racks.
- 22 inches L x 28-1/2 inches W x 70 inches H overall.
- Four, 5-inch stem type casters with polyolefin wheels, two with locks.



NOTE: Platters sold separately. SEE RIGHT.

ITEM NO.	CAPACITY	EACH
3775 1137	400 lb.	\$568.53

Knock-Down Aluminum Deli Platter Dolly



- Designed to hold 12-inch x 30-inch platters on 1-5/8 inch angles with built-in easy slide ribs.
- Uprights are reinforced with a channel to help prevent breakage from the stem casters.
- Framework is constructed of 1-inch square x 0.07-inch wall tubing. Angle runners are constructed of 1-1/4 inch x 1-5/8 inch x 0.100 inch wall angle.
- Includes four, 5-inch swivel stem casters, 2 with brakes.
- All aluminum — will not rust.
- Capacity: 500 pounds when weight is evenly distributed.

NOTE: Other sizes available by CUSTOM ORDER.

NOTE: Platters sold separately. SEE RIGHT.



Built-in easy-slide ribs allow platters to glide smoothly.

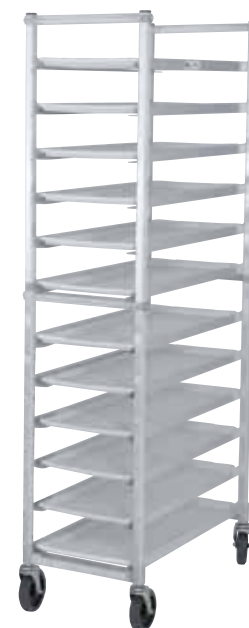

ITEM NO.	PRODUCT	DIMENSIONS	RUNNER SPACING	SHIPPING WT.	F.O.B. FACTORY EACH
3775 1348	10-Platter Capacity	15-1/4" x 30" x 69"	6"	43 lb.	\$501.65
3775 1347	12-Platter Capacity	15-1/4" x 30" x 69"	5"	45 lb.	598.85
0844 22191	Replacement Swivel Stem Caster (uses 2)				19.65
0844 22201	Replacement Swivel Stem Caster with Brake (uses 2)				23.79

Platters

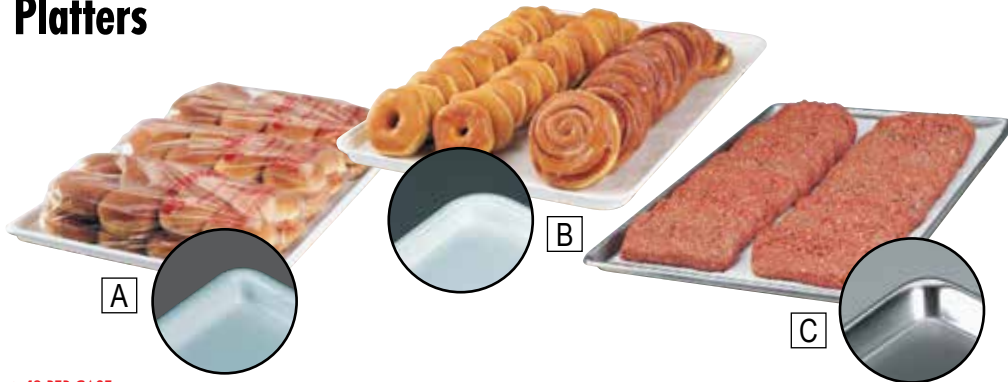

▶ 12 PER CASE.

ITEM NO.	PRODUCT	DIMENSIONS	EACH
3195 29961	A. Polystyrene	18" x 26" x 1.1"	\$17.95
1695 12241	Polystyrene	12" x 24" x 3/4"	17.56
2432 18261	B. Fiberglass	18" x 26" x 1.1"	36.49
3013 11641	C. Stainless Steel	18" x 26" x 1"	90.15
3013 21211	Stainless Steel	18" x 13" x 1"	58.95

*Not to be used with vegetable oil.

Mini Platter

- Designed specifically for case display of meats and other packaged foods.
- Heavy-duty plastic is lightweight and easy to clean.

NOTE:
For steak papers, SEE BELOW.



▶ 12 PER CASE.

ITEM NO.	DIMENSIONS	EACH
4219 12301	12-1/2" x 30" x 3/4"	\$14.59

Knock-Down Stainless Steel Platter Dollies

- Four, 5-inch swivel casters, two with brakes.
- 1-inch square welded stainless steel.
- Dimensions: 20-1/4 inches L x 28 inches D.

A. 10-Platter Dolly: 58 inches H overall.

B. 20-Platter Dolly: 69-1/4 inches H overall.



NOTE: Platters sold separately. SEE ABOVE.

ITEM NO.	PRODUCT	CAPACITY	RUNNER SPACING	EACH
2990 2939	A. 10 Platter	300 lb.	4-3/4"	\$1,709.80
2990 2985	B. 20 Platter	500 lb.	2-7/8"	2,888.90

Platter Liners

- Interleaved for serving and storage.
- Allows complete release from platters.
- Easy cleanup. • FDA compliant.



▶ 1,000 PER CASE.

ITEM NO.	DIMENSIONS	CASE
7500 3991	16-2/5" x 24-2/5"	\$128.21



Steak Paper

- Designed to keep meat juices locked in.
- FDA and USDA compliant.
- Sheet size: 9 inch x 12 inch.

▶ 1,000 PER CASE.

ITEM NO.	PRODUCT	CASE
1640 1912	Green	\$55.45
1640 0075	Black	73.85
1640 6902	Peach	52.95



Disposable Platter Dolly Cover

- Clear plastic cover protects product from dust and contaminants.
- Fits 10-platter dolly, as pictured, without dragging on ground.



▶ 50 COVERS PER ROLL.

ITEM NO.	PRODUCT	DIMENSIONS	ROLL
7500 1750	Dolly Cover	.52" x 80"	\$31.38

Knock-Down Aluminum Universal Pan Rack



- Easy clean bar slides are 3-3/4 inches wide.
- Holds 18-inch x 26-inch half and full sized sheet pans by the base of the pan.
- Holds 12-inch x 20-inch steam pans by the lip of the pan (sold separately).
- Strong and durable aluminum will not rust.
- Easy assembly, ships “knocked down”.
- Includes 5-inch swivel stem casters.
- Dimensions: 22-3/4 inches L x 26 inches W x 73-3/4 inches H.



Holds platters and steam pans.

NOTE: Platters and steam pans sold separately. For steam pans, SEE RIGHT.

▶ SEE PAGE 203 For Platters



F.O.B. FACTORY			
ITEM NO.	PRODUCT	SHIPPING WT.	EACH
2510 3020	10-Pan Capacity . . .	58 lb.	\$966.05
2510 3021	15-Pan Capacity . . .	76 lb.	1,207.35
2510 3019	20-Pan Capacity . . .	95 lb.	1,540.35

Super Pan V[®] Steam Table Pans



- Pans are constructed of 22-gauge stainless steel to resist rust and corrosion.
- Reinforcer[®] corners won't bend and will withstand more impact than ordinary pans.
- Coved corners make scooping easier and allow for easy clean-up.
- Anti-jamming design keeps pans from sticking together when stored.
- Flat edges keep pans tight in steam table well to seal in heat.
- Optional covers have reinforced edges and fit securely to prevent spills during transport.



▶ 6 PER CASE.

			F.O.B. FACTORY
ITEM NO.	PRODUCT	DIMENSIONS	EACH
7160 13221	A. 1/3 Pan	6-9/10" x 12-3/4" x 2-1/2"	\$30.79
7160 13421	B. 1/3 Pan	6-9/10" x 12-3/4" x 4"	40.33
7160 13621	C. 1/3 Pan	6-9/10" x 12-3/4" x 6"	52.95
7160 01371	D. 1/3 Pan Cover		28.75
7160 00601	E. Half Pan	10-2/5" x 12-3/4" x 2-1/2"	34.15
7160 20241	F. Half Pan	10-2/5" x 12-3/4" x 4"	40.02
7160 00621	G. Half Pan	10-2/5" x 12-3/4" x 6"	58.41
7160 01361	H. Half Pan Cover		31.29
7160 63301	I. Full Pan	20-3/4" x 12-3/4" x 2-1/2"	50.93
7160 70971	J. Full Pan	20-3/4" x 12-3/4" x 4"	58.09
7160 00541	K. Full Pan	20-3/4" x 12-3/4" x 6"	90.68
7160 01471	L. Full Pan Cover		54.06

Aluminum Pan/Platter Dolly

- For use moving and storing 26 inch x 18 inch pans/platters.
- Includes four, 3-inch zinc-plated swivel caster rigs and hardware.
- Aluminum base will not rust. • Shipping weight: 12-1/2 pounds.

▶ SEE PAGE 203 Platters Sold Separately



Corners are open for easy cleaning.

ITEM NO.	DIMENSIONS	EACH
3775 8326	18-2/5" x 26-1/2" x 6"	\$161.60



Retractable Shelf, Side Load Cart

Locking casters keep the cart completely still when needed.

- Retractable shelf can hold 18-inch x 26-inch or 9-inch x 26-inch platters or pans.
- Top has built-in center I-beam constructed of 1-1/2-inch square wall tubing for extra support.
- Holds up to 6 platters (sold separately).
- Base construction: 1-1/2 square x 0.07-inch wall tubing.
- Top framework construction: 1-1/2 square x 0.07-inch wall tubing.
- Angle runner construction: 1-1/4-inch x 1-5/8-inch x 0.1-inch angle.
- The top and retractable shelf are constructed of 16-gauge stainless steel.
- Shipping weight: 58 pounds.

▶ SEE PAGE 464

FOR FOOD SLICER AND GRINDERS



Easy glide angle runners make sliding platters in and out an easy task.



Casters have total locking capabilities, making this unit completely rigid and non-moving when needed.

NOTE: Platters and food slicer sold separately.



Includes four, 5-inch platform-type, total-locking, swivel casters with sealed bearings.

F.O.B. FACTORY EACH

ITEM NO.	PRODUCT	DIMENSIONS	F.O.B. FACTORY EACH
3775 9217	Retractable Shelf Prep Cart	28-2/5" x 30" x 20" . . .	\$1,137.24
0844 22151	Replacement 5" Total Locking Casters		28.75



SIGN UP FOR OUR eDEALS

Get exclusive offers not found anywhere else!

eDEAL SIGN-UP FORM AVAILABLE ON OUR WEBSITE.

www.bunzlpd.com

Large Food Boxes

- Shatter and crack-resistant containers with date control panels.
- NSF certified and commercial dishwasher safe.
- Record freshness dates with a grease pencil.
- Tight-fitting lids for longer shelf life.
- Assists in HACCP compliance.

White, DUR-X™ Food Boxes

▶ 6 PER CASE.

ITEM NO.	DIMENSIONS	CAPACITY	EACH
1770 35071	18" x 12" x 3-1/2"	.2 Gallon	\$20.45
1770 79721	18" x 12" x 6"	.3-1/2 Gallon	25.85
1770 79681	18" x 12" x 9"	.5 Gallon	32.35
1770 08561	26" x 18" x 6"	.8-1/2 Gallon	42.05
1770 00281	26" x 18" x 9"	1.2-1/2 Gallon	62.55
1770 79641	26" x 18" x 15"	2.1-1/2 Gallon	86.35

White, DUR-X™ Lids

▶ 6 PER CASE.

ITEM NO.	DIMENSIONS	EACH
1770 79661	Fits 26" x 18" Boxes	\$25.85
1770 79741	Fits 18" x 12" Boxes	15.05

Clear, CARB-X® Food Boxes

▶ 6 PER CASE.

ITEM NO.	DIMENSIONS	CAPACITY	EACH
1770 33081	26" x 18" x 6"	.8-1/2 Gallon	\$56.05
1770 79141	26" x 18" x 9"	1.2-1/2 Gallon	72.75
1770 33281	26" x 18" x 12"	1.6-3/5 Gallon	90.95

Clear, CARB-X® Lids

▶ 6 PER CASE.

ITEM NO.	DIMENSIONS	EACH
1770 79181	Fits 26" x 18" Boxes	\$32.35



NOTE: Use a grease pencil to write directly on boxes!

Aluminum Universal Rack

Ideal for transporting various sized platters, trays, boxes and totes.

- Framework constructed of 1-inch square x 0.07-inch wall tubing.
- Strong and durable, all welded aluminum construction will not rust.
- Shelves are constructed of 1/2-inch x 1-1/4-inch oval tubing.



Oval tubing shelves provide easy access.



Equipped with four, 5-inch swivel plate casters, two with brakes.

NOTE: Tote, freezer basket, platters and food boxes sold separately.

ITEM NO.	PRODUCT	DIMENSIONS	SPACING BETWEEN SHELVES	SHIPPING WT.	F.O.B. FACTORY EACH
3775 1354	5-Shelf	16" x 32-1/2" x 42"	7-1/4"	37 lb.	\$460.94
3775 1356	6-Shelf	20-9/10" x 27" x 67"	10-1/2"	47 lb.	568.53
3775 1357	7-Shelf	28-1/2" x 32" x 69"	.9"	60 lb.	952.15
3775 1358	8-Shelf	20-9/10" x 27" x 67"	7-1/4"	46 lb.	682.91
0844 22161	Replacement Heavy-Duty Caster, Plate Swivel (Uses 2)				23.23
0844 22171	Replacement Heavy-Duty Caster, Plate w/Brake (Uses 2)				29.79



▶ SEE PAGE 252

FOR MORE FOOD STORAGE CONTAINERS



Multi-Use Tray

These trays are perfect for extreme industrial applications that compromise injected or thermoformed trays.

- Straight sidewalls and no rims.
- Color: natural.
- Approved for food contact.
- Shipping weight: 9 pounds.



ITEM NO.	PRODUCT	DIMENSIONS	EACH
4743 20081	Multi-Use Tray	37-1/2" x 25" x 2-1/2"	\$101.48

Three Tier Tray Cart

Designed to hold three multi-use trays (above).

- Includes 5-inch casters: two rigid and two swivel with brake.
- 1-1/4-inch square aluminum tubing construction.



ITEM NO.	PRODUCT	DIMENSIONS	EACH
3775 0472	Aluminum Cart	28.1" x 40-2/5" x 53-1/4"	\$980.98

Heavy-Duty Mixer Bowl Dolly

Maneuver easily from one station to the next.

- Guaranteed rust free.
- Constructed of 1-1/2-inch welded tubing.
- 5-inch platform type swivel casters.

NOTE: Mixing bowl NOT INCLUDED.



Ring size: 20-1/4 inches ID



ITEM NO.	PRODUCT	DIMENSIONS	CAPACITY	SHIPPING WT.	EACH
3775 9936	A. Low-Profile Bowl Dolly	14" x 14" x 7-1/2"	.80 qt.	15 lb.	\$257.32
3775 5636	B. High-Profile Bowl Dolly	26-3/4" x 20-3/4" x 28-3/4"	.80 qt.	34 lb.	\$597.58

Dough Boxes

- Rigid polycarbonate reinforced on all sides.
- Prevents crusting and reduces frequency of dough making.
- Boxes stack securely and are dishwasher safe.
- Boxes available in two depths.
- Boxes have rounded edges for safety.



NOTE: Cover sold separately.

> 6 PER CASE.

ITEM NO.	PRODUCT	DIMENSIONS	EACH
2432 63551	3" Dough Box	18" x 26" x 3"	\$48.12
2432 38111	6" Dough Box	18" x 26" x 6"	\$57.29
2432 63561	Cover		\$34.35

Aluminum Dough Box Dolly

- For use moving and storing dough boxes or platters.
- Corners are open for easy cleaning.
- Includes four, 3-inch zinc-plated swivel caster rigs and hardware.
- Aluminum base will not rust.
- Shipping weight: 12-1/2 pounds.



NOTE: Dough boxes sold separately. SEE ABOVE.



> SEE PAGE 203 For Platters

ITEM NO.	PRODUCT	DIMENSIONS	EACH
3775 8326	Aluminum Pan Dolly	18-2/5" x 26-1/2" x 6"	\$161.60

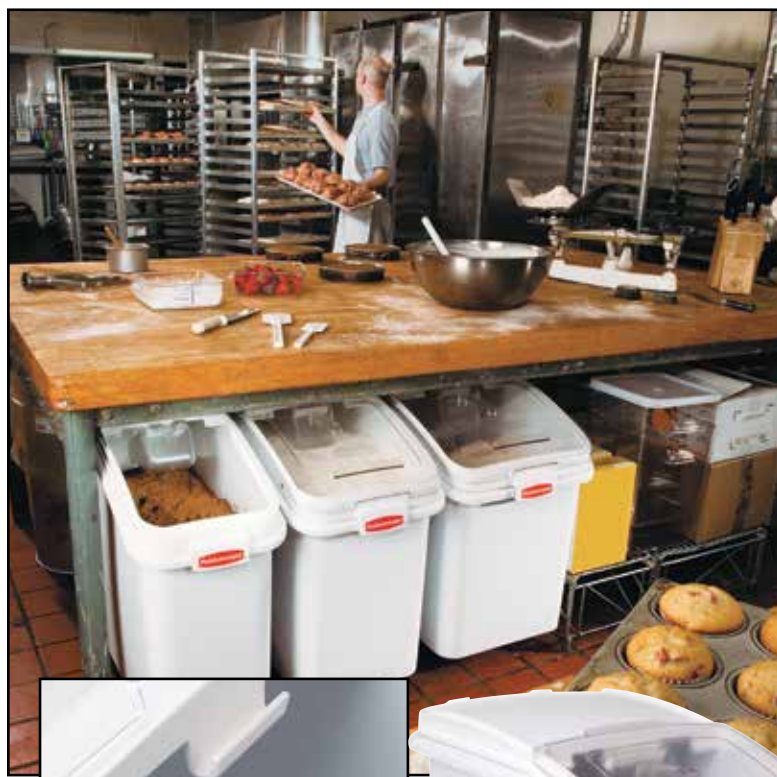

Scoop hook to make scoop easily accessible.



Scoop handle is held out of ingredient bin preventing cross-contamination.



Snap fit secures to base to make handling easier.



3-inch casters.

ProSave™ Ingredient System

Increase productivity, improve food safety and decrease supply costs.



- Scoop hook allows the scoop to be stored inside the bin and out of the product for quick access to each ingredient.
- By holding the scoop handle and securing it to the hook, hands do not touch the ingredients and the risk of cross-contamination is decreased.
- Integrated sliding lid for one handed access.
- See-thru lid slides along easy-glide track, to open.
- Assists in complying with FDA Food Code 30304.12.
- First in, first out (FIFO) fill compartment.



Rotating clear lid fits on 10-, 20-, or 32-gallon round containers (sold separately).

Scoop included and is easily stored inside. 10-gallon lid includes 2-cup scoop. 20-gallon lid includes 3-cup scoop. 32-gallon lid includes 4-cup scoop.

ITEM NO.	PRODUCT	DIMENSIONS	CAPACITY	FLOUR/SUGAR CAPACITY	SHIPPING WT.	EACH
1770 0017	A. 170 lb Slant-Front Storage Bin and 32 oz. Scoop	29-1/4" x 13.13" x 28"	20-1/2 Gallon	124 lb/158 lb	27.7 lb	\$454.45
1770 0018	200 lb Slant-Front Storage Bin and 32 oz. Scoop	29-1/2" x 15-1/2" x 28"	26-1/5 Gallon	154 lb/197 lb	32.7 lb	507.35
1770 0019	250 lb Slant-Front Storage Bin and 32 oz. Scoop	29-3/4" x 18" x 28"	30-4/5 Gallon	188 lb/240 lb	38.7 lb	528.95

ITEM NO.	PRODUCT	CAPACITY	EACH
1770 0343	B. 10 Gallon ProSave™ Lid, White	2-Cups	\$76.65
1770 0344	20 Gallon ProSave™ Lid, White	3-Cups	109.55
1770 0522	32 Gallon ProSave™ Lid, White	4-Cups	131.55

▶ 2 PER CASE.

ITEM NO.	PRODUCT	EACH
6387 33171	D. Twist-on Dolly	\$50.15

ITEM NO.	PRODUCT	EACH
6387 24401	C. 10-Gallon Round Drum, White	\$21.62
6387 24631	20-Gallon Round Drum, White	31.69
6387 24831	32-Gallon Round Drum, White	42.08

ITEM NO.	PRODUCT	EACH
1770 9142	170 lb Replacement Lid and 32 oz. Scoop	\$165.55
1770 0800	200 lb Replacement Lid and 32 oz. Scoop	199.35
1770 0979	250 lb Replacement Lid and 32 oz. Scoop	184.65
3414 0004	Replacement 3" Swivel Casters	18.52
3414 0005	Replacement 3" Rigid Casters	19.82

For More Drum Colors ▶ SEE PAGES 257 - 258



► SEE PAGE 251
For Replacement Scoops

FIFO barrier aids in proper rotation of ingredients.



E

Integrated Safety Portioning Scoop and hook provide dedicated scoop storage for safe ingredient portioning.



F

Lid design provides one-handed access to ingredients while stacked on a shelf or under a prep table. Lid can swivel and rest under or over bin opening



ITEM NO.	PRODUCT	DIMENSIONS	CAPACITY	FLOUR/SUGAR CAPACITY	EACH
1770 5557	E. 100-Cup Shelf Storage Bin and 2-Cup Scoop	23-1/2" x 11-1/2" x 16-9/10"	6-1/4 Gallon	25 lb/50 lb	\$203.45
1770 5558	F. 200-Cup Shelf Storage Bin and 2-Cup Scoop	23-1/2" x 19-1/5" x 16-9/10"	12-3/5 Gallon	50 lb/100 lb	289.05

XTra™ Utility Cart

Versatile and attractive, perfect for high visibility situations.

- Three shelf unit. • Large shelves: 33 inches x 20 inches.
- Easy to clean and store. • Capacity: 300 pounds.
- Color: off-white.



▶ SEE PAGES 188 -189 and 192
Totes Sold Separately

ITEM NO.	PRODUCT	DIMENSIONS	EACH
1770 0711	Utility Cart	20" x 40-3/5" x 37-4/5"	\$429.35
3414 5738	Replacement 4" Swivel Casters.		19.61
3414 00931	Replacement Aluminum Upright Kit (8 pieces).		66.73

Flat Shelf Utility Cart

Perfect for transporting materials, supplies and heavy loads in almost any environment.

- Ergonomically designed push handle provides optimum hand placement and push height improving control and worker safety.
- Molded-in storage compartments, holsters, hooks and notches.
- Best-in-class casters to meet the most demanding environments.
- High density structural resin construction.
- Storage weight capacity: 500 pounds.
- Molded-in customizable fittings.
- Easy-access bottom shelf.
- Color: black.



Convenient storage bin built into handle.



NOTE: More replacement parts available visit WWW.BUNZLPD.COM

ITEM NO.	PRODUCT	DIMENSIONS	EACH
1770 4503	Small, Utility Cart	37-9/10" x 19" x 33"	\$439.85
1770 0526	Large, Utility Cart	43-9/10" x 25-9/10" x 33"	443.25
3414 0058	Replacement Hardware Kit		4.69
0844 01861	Replacement 5" Rigid Plate Caster		16.65
0844 01871	Replacement 5" Swivel Plate Caster		18.55

Heavy-Duty Utility Carts

Heavy-duty structural foam plastic construction won't rust, dent, chip or peel.

- Molded-in storage compartments, holsters, hooks and notches.
- Ergonomically designed push handle for greater maneuverability.
- High density structural resin construction.
- Easy access bottom shelf.
- Includes casters designed for the most demanding environments.



Molded-in storage compartment in handle.



ITEM NO.	PRODUCT	DIMENSIONS	COLOR	CAPACITY	EACH
1770 0090	Standard Shelf Cart	39" x 17-9/10" x 33-1/4"	Black	500 lb.	\$336.25
1770 4500	Standard Shelf Cart	39" x 17-9/10" x 33-1/4"	Beige	500 lb.	336.25
1770 2093	Large Shelf Cart	45-1/4" x 25-9/10" x 33-1/4"	Black	500 lb.	371.55
1770 2089	Large Shelf Cart	45-1/4" x 25-9/10" x 33-1/4"	Beige	500 lb.	371.55
1770 4550	Extra Large Shelf Cart	55" x 26" x 33-1/4"	Black	750 lb.	618.95

▶ SEE PAGE 571

FOR KNOBBY MATS®

Use as an anti-fatigue mat or for equipment protection on utility carts, shelving and work stations.

Replacement Parts

ITEM NO.	PRODUCT	EACH
0844 01861	Replacement 5" Rigid Plate Caster	\$16.65
0844 01871	Replacement 5" Swivel Plate Caster	18.55
3414 00631	Cart Leg, Black	24.28
3414 0058	Replacement Hardware Kit	4.69
3414 00901	Kit w/4-Casters	64.20

3-Shelf Utility Carts

- Colored carts help facilitate the organization of products, cleaning tools and equipment.
- Cart contains two convenient ergonomic handles.
- Smooth surface is easy to clean.
- Casters constructed of resin help eliminate added noise, unlike metal carts.
- Capacity: 200 pounds.



NOTE: Replacement shelves available.
WWW.BUNZLPD.COM

ITEM NO.	PRODUCT	DIMENSIONS	EACH
1770 3426	A. Black.	33-3/5" x 18-3/5" x 37-3/4"	\$383.35
1770 3423	B. Platinum	33-3/5" x 18-3/5" x 37-3/4"	407.65
3414 5738	Replacement 4" Swivel Casters.		19.61

Solid Shelf Aluminum Equipment Stands

Constructed with a marine edge to contain spills.

- Load rating is 400 pounds per shelf.
- Shelves are constructed of 0.040 inch aluminum with 1-1/2-inch square x 0.07-inch wall tube reinforcement.
- Use as a stationary unit or add optional caster set and turn stand into a mobile unit.
- Posts constructed of 1-5/16-inch aluminum pipe with a 5/32 inch wall thickness.
- Ideal for use with scales, label printers, vacuum machines, patty machines, slicers, tenderizer or mixers.

24 Inch Height

30 Inch Height w/Casters

ITEM NO.	SHELF SIZE	SHIPPING WT.	EACH
3775 5100	18" x 24"	20 lb.	\$342.65
3775 5101	18" x 30"	23 lb.	342.65
3775 5102	18" x 36"	23 lb.	350.60
3775 5103	20" x 24"	23 lb.	378.16
3775 5104	20" x 30"	25 lb.	396.60
3775 5105	20" x 36"	26 lb.	372.96



Edge built to contain spills.

30 Inch Height

36 Inch Height w/Casters

ITEM NO.	SHELF SIZE	SHIPPING WT.	EACH
3775 5110	18" x 24"	21 lb.	\$355.79
3775 5111	18" x 30"	24 lb.	355.79
3775 5112	18" x 36"	24 lb.	374.13
3775 5113	20" x 24"	24 lb.	393.95
3775 5114	20" x 30"	25 lb.	392.57
3775 5115	20" x 36"	26 lb.	397.77

36 Inch Height

42 Inch Height w/Casters

ITEM NO.	SHELF SIZE	SHIPPING WT.	EACH
3775 5120	18" x 24"	18" x 24"	\$384.83
3775 5121	18" x 30"	18" x 30"	384.83
3775 5122	18" x 36"	18" x 36"	384.73
3775 5123	20" x 24"	20" x 24"	424.27
3775 5124	20" x 30"	20" x 30"	401.79
3775 5125	20" x 36"	20" x 36"	401.79

Heavy-Duty Metal Utility Carts

Easy to handle carts can be maneuvered through corridors and doorways without difficulty.

- Cart come with 2 adjustable shelves for added versatility.
- Constructed of powder-epoxy over zinc-chromate electroplating.
- NSF approved for wet or dry use. • Capacity: 1,200 pounds.



A. Carts with Poly Swivel Casters

ITEM NO.	DIMENSIONS	EACH
5268 2467	36" L x 24" W x 39" H	\$245.22
5268 2460	60" L x 24" W x 39" H	294.95



B. Cart with Pneumatic Casters

ITEM NO.	DIMENSIONS	EACH
5268 2461	48" L x 24" W x 42" H	\$645.95



Stand shown with optional caster kit.

Add the optional caster kit for mobile stand conversion. Includes: four, 5-inch all black polyolefin wheels with 1-inch swivel, stem-type casters, each with locking brake.

Caster Kit



ITEM NO.	PRODUCT	EACH
0844 39005	Four Caster Kit.	\$107.88



Folds down to 20" x 15", stores upright and takes up less space than a stack of totes.



Narrow Stock Truck

Capable of holding five hand truck loads worth of product.

- Totes are easily accessible reducing ordering picking time.
- Easily maneuvers through tight spaces without blocking aisles.
- Each dolly has the capacity to hold up to 50 pounds of product per tote.
- Made of heavy-duty 1-1/4 inch x 1-1/2 inch D-shaped tube hoop frame.
- Four: 5-inch platform casters, 2 swivel and 2 rigid.
- Hold 16 inch W x 25 inch L x 8-1/2 inch H totes.
- All seams are welded and sealed.



D-shaped aluminum tube.



Holds two optional, drop-on shelves.

► SEE PAGES 238-241
Replacement Caster Options

► SEE PAGE 188
Totes Sold Separately



Shown with optional drop-on shelves, provides enough space for twelve 15" x 20" picking totes.

ITEM NO.	PRODUCT	DIMENSIONS	CAPACITY	SHIPPING WT.	EACH
3775 0100	Narrow Stock Truck	20" x 64-9/16" x 66-3/4"	1,500 lb	84 lb.	\$1,118.28
3775 0101	Optional Drop-On Shelf				676.82



Stainless Steel Platform Truck

Built to last a lifetime!

- 14-gauge stainless steel truck is ideal for use in wet or corrosive areas.
- One-piece platform with 2 inch turned down edges is rust-proof and completely sanitary, no crevices to trap dirt.
- Includes two swivel and two rigid casters with rugged 8-inch white plastic wheels in the standard four-corner configuration.
- Handle is removable. • Shipping weight: 102 pounds.



ITEM NO.	PRODUCT	DIMENSIONS	CAPACITY	EACH
2990 3369	Stainless Steel Platform Truck	30" x 60"	1,200 lb.	\$1,766.15

Aluminum Stock Truck

Transport heavy loads from back room to sales floor.

- All-aluminum truck is light-weight and easy to maneuver, yet sturdy enough to let you load heavy boxes.
- Unit fits down most aisles, rounded front protects walls.
- Folds compactly to store conveniently and safely.
- Six heavy-duty casters.
- Shipping weight: 50 pounds.



ITEM NO.	PRODUCT	DIMENSIONS	CAPACITY	EACH
3775 3796	Aluminum Stock Truck	63-1/2" x 18" x 62"	1,500 lb	\$669.76

Heavy-Duty Platform Trucks

Ideal for moving large, heavy, oversized loads in a variety of environments.

- Exclusive, precision-engineered resin and metal composite structure provides maximum load support.
- Non-marking polyolefin casters are impact and chemical resistant and won't flat-spot under static loads.
- Powder-coated steel creates a hard finish that is tougher than conventional paint. • Textured deck surface reduces load slippage.
- Perimeter deck channel retains small items. • Variable grip-height improves control and worker safety.
- Retainer clips prevent unintended handle removal.

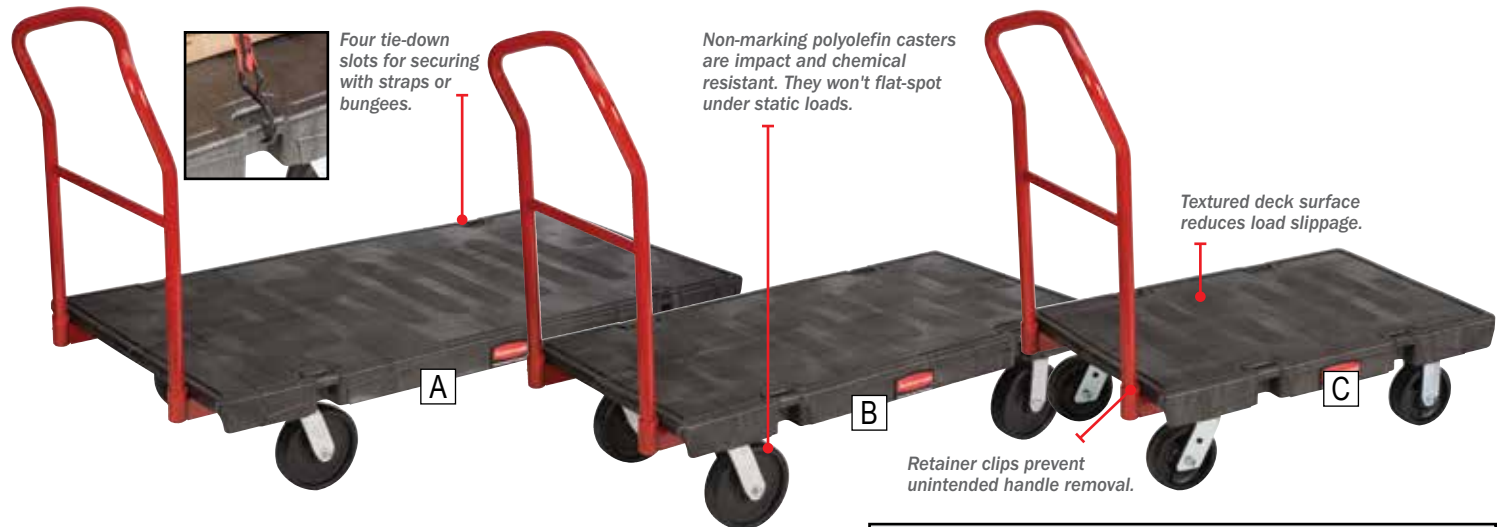

NOTE: More replacement parts available visit WWW.BUNZLPD.COM

Replacement Parts

ITEM NO.	PRODUCT	CAPACITY	SHIPPING WT.	EACH
1770 0171	A. 30" x 60"	2,000 lb	100 lb.	\$944.75
1770 4442	B. 24" x 48"	2,500 lb	80 lb.	816.05
1770 4414	C. 24" x 36"	2,000 lb	63 lb.	784.55

ITEM NO.	PRODUCT	EACH
3414 01021	Replacement Valco Clip for Platform	\$5.59
3414 01031	Replacement Truck Hardware Kit	13.70
3414 00811	Replacement 24" Crossbar Handle	85.13
3414 00991	Replacement 30" Crossbar Handle	85.13

Triple Trolley Deck Cart

Three ways to keep your work moving.

- Three-position handle lets user push, pull, or fold flat for use as a dolly.
- Moves on easy-to-push 5-inch heavy-duty casters
- Holds up to 500 pounds, yet weighs less than 25 pounds.
- Made from a durable structural foam which will not rust, dent or bend.
- Back wheels pivot for easy and smooth maneuvering around corners.
- Large non-skid surface: 32-1/2 inches x 20-1/2 inches.
- Folds down for easy transport and storage.
- Color: black.



► SEE PAGE 257-258
Drums Sold Separately



ITEM NO.	PRODUCT	DIMENSIONS	CAPACITY	EACH
1770 4405	Triple Trolley Deck Cart.	32-1/2" x 20-1/2"	500 lb.	\$256.95
0844 01861	Replacement 5" Rigid Plate Caster			16.65
0844 01871	Replacement 5" Swivel Plate Caster			18.55

Heavy Duty Stock Truck w/ Solid Aluminum Top

For use in any application that requires maximum strength and durability.

- All welded aluminum constructions.
- Four plate type casters: two swivel w/ brake and two rigid.
- Top Shelf Height: 30"
- Shelf Spacing: 18"



Handle constructed of 1-5/16" diameter pipe.



ITEM NO.	PRODUCT	DIMENSIONS	CAPACITY	SHIPPING WT.	EACH
3775 0102	Stainless Steel HD Stock Truck 21" x 44" x 59-1/2" 3,000 lb 65 lb	\$1,162.24

Aluminum Boxed-Beef Shelf Truck

- All welded, heavy-duty corrosion-resistant aluminum alloy.
- Strong 1-1/4-inch x 2-1/4-inch cross members.
- Load capacity: 1,800 pounds.
- Shipping weight: 70 pounds.
- Two rigid and two swivel 6-inch casters with white poly wheels.



Channel Deck Platform Truck

Rounded nose helps decrease damage to walls and doors.

- Constructed with tube frame and a channel deck to help minimize product fall through.
- Easy-to-grip 1-5/8 inch diameter pipe handle removes easily.
- Equipped with two rigid and two swivel, heavy-duty 8 inch diameter casters with grease zerks in swivel and hub. Replacement casters available.
- Strong and durable aluminum will not rust.
- Handle length: 44-1/2 inches.
- Choose from 5 sizes of trucks.



ITEM NO.	DIMENSIONS	CAPACITY	EACH
3775 3100	27" x 63" x 70"	1,800 lb	\$924.48

ITEM NO.	PRODUCT	SHIPPING WT.	CAPACITY	F.O.B. FACTORY EACH
3775 9320	20" x 36" Truck	47 lb	2,000 lb	\$626.30
3775 9321	20" x 48" Truck	48 lb		669.76
3775 0322	20" x 60" Truck	53 lb		663.08
3775 9323	30" x 48" Truck	57 lb		782.65
3775 9324	30" x 60" Truck	61 lb		927.13
0844 22121	Replacement Swivel Caster (Requires 2)			52.53
0844 22141	Replacement Rigid Caster (Requires 2)			75.97

Hand Trucks, 600 Pound Capacity

A. Heavy-Duty Truck

14-inch L x 9-inch W nose plate.

- Rugged, all-welded 1-inch OD 14-gauge steel frame with dual handles and molded grip for improved control and stability.
- Curved back, center support for better handling around objects.

B. Economy P-Handle Truck

14-inch x 7-1/2-inch nose plate.

- P-handle design allows for one-handed operation. • 16-gauge frame.

ITEM NO.	PRODUCT	DIMENSIONS	SHIPPING WT.	EACH
0844 1002	A. Heavy-Duty Dual Handle Truck	.46" x 13" x 17"	33 lb.	\$249.94
0844 1001	B. Economy P-Handle Truck	.51-1/2" x 21-1/2"	26 lb.	236.56



Full pneumatic 10-inch ball bearing wheels make this truck great for outdoor use.

Drum Hand Truck, 800 Pound Capacity

Two in one: utility of both a hand truck and drum truck.

- Constructed of 1-inch heavy-duty pipe frame.
- Curved frame accommodates 5-gallon pails and kegs; chime hook works with 30- and 55-gallon drums.
- 8-inch x 2-inch cast iron wheels with molded on rubber and wheel guards; 3/4-inch axle and bearing.
- Nose plate: 14 inches x 8 inches.
- Shipping Weight: 42-1/2 pounds.



ITEM NO.	PRODUCT	DIMENSIONS	EACH
7447 0349	Drum Hand Truck	48" x 20-1/2"	\$356.67
7447 0576	Replacement Wheel		84.31

Dual Handle Drum Hand Truck, 1,000 Pound Capacity

- Twin handle, self-standing, heavy-duty, 1-inch structural pipe frame with all joints double welded.
- 10-inch x 2-1/2-inch molded-on rubber wheels over cast iron center.
- Floating axle reduces effort required to break over and balance load.
- Replaceable hard faced double-beveled nose prongs.
- Handles 55-gallon drums; chime hook can be stored at top of frame for easy use



ITEM NO.	DIMENSIONS	SHIPPING WT.	EACH
7447 4003	61" x 23-3/4"	74 lb.	\$630.53



Aluminum Hand Truck Pallet

Ideal for moving small cases and bags of product.

- Reduces the unstacking of product — put the product on the pallet, move it and leave it without having to unstack it off the hand truck.
- Use with any hand truck with a nose plate of 8 inches or longer.
- Heavy-duty aluminum wall tubing construction.
- Shipping Weight: 11 pounds.
- Capacity: 400 pounds.

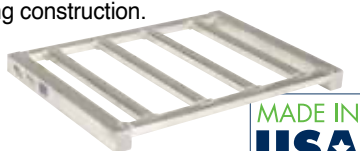

NOTE: This pallet works with hand trucks #0844 1002 and 7447 0349, sold separately. SHOWN ABOVE.



Scan this QR code with your mobile device to view a video of the pallet features.



ITEM NO.	PRODUCT	DIMENSIONS	EACH
3775 0010	Hand Truck Pallet	15-1/2" x 21" x 1-1/2"	\$116.76

Greenline Economy Convertible 2-in-1 Hand Truck



Converts between two-and four-wheel positions.

- Heavy-duty tubular steel construction with wheel guards.
- Folds upright for easy storage when not in use.
- Lever activated position conversion.
- Bed size: 13-3/4 inches x 48 inches.
- 10-inch x 2-3/4-inch solid rubber wheels. 5-inch x 1-3/8-inch moldon polyurethane swivel casters.
- Capacities: 2 wheels: 700 pounds; 4 wheels: 800 pounds.
- Nose plate: 18 inches x 8-1/2 inches.
- Shipping weight: 77 pounds.

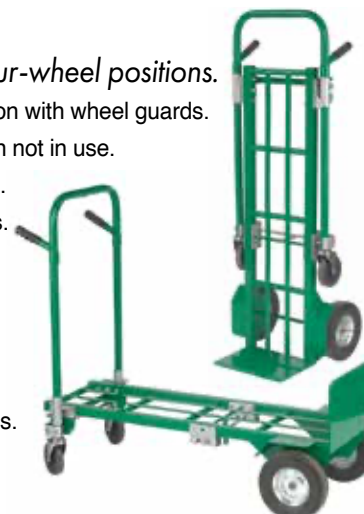

ITEM NO.	PRODUCT	DIMENSIONS	EACH
7447 0639	Convertible Hand Truck	19-1/2" x 58" x 18"	\$358.74
7447 84791	Replacement Rubber Wheel		42.81
7447 21401	Replacement Caster		34.86

Structural Foam Tilt Trucks

- Durable structural foam one-piece plastic construction eliminates need for metal frame that can harbor bacteria.
- “Constant force” design makes it easier and safer to go from a kneeling position to the full dumping position.
- Fits through standard commercial doorways and onto elevators easily.
- Ergonomic steering handle provides utmost control when maneuvering and dumping.
- Secondary handle on underside of truck provides further control when dumping contents.
- Non-marking, casters are inset to prevent damage to walls, doors and fixtures.
- Available in three different degrees of ruggedness and four different capacities.
- Color: black.

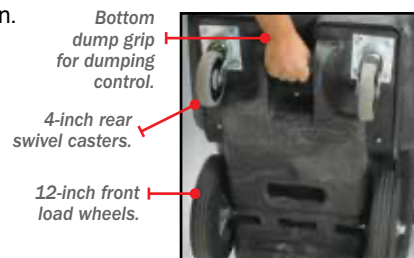

NOTE: Hinged lid sold separately.



Scan this QR code with your mobile device to view a video of the features of these Tilt Trucks.

ITEM NO.	PRODUCT	DIMENSIONS	CAPACITY	EACH
1770 0095	A. Utility-Duty	53-1/5" x 26-9/10" x 33-9/10"	.450 lb/0.5-cu. yd.	\$731.45
1770 9311	B. Standard-Duty	57-2/5" x 26-9/10" x 33-9/10"	.850 lb/0.5-cu. yd.	939.00
1770 1012	Standard-Duty	64-1/2" x 30-1/5" x 38"	.600 lb/0.75-cu. yd.	984.15
1770 1015	Standard-Duty	64-1/2" x 30-1/5" x 38"	1,000 lb/0.75-cu. yd.	1,046.65
1770 1500	Standard-Duty	70-4/5" x 33-1/2" x 42-1/5"	1,250 lb/1-cu. yd.	1,475.65
1770 1601	C. Heavy-Duty	70-4/5" x 33-1/2" x 42-1/5"	2,100 lb/1-cu. yd.	1,475.65
1770 0351	Lid for .75 cu. yd. (For Item #'s 1770 1012 and 1770 1015)			F.O.B. FACTORY \$301.95
1770 1704	Lid for 1-cu. yd. (For Item #'s 1770 1500 and 1770 1601)			F.O.B. FACTORY 317.95
3414 01041	Replacement Handle Bracket			5.95
3414 1111	Replacement 12" Wheel			104.95
3414 1112	Replacement 4" Non-Marking Plate Swivel Caster			32.33

Angled Dump Tubs

- Durable, one piece high-density polyethylene.
- Smooth interior for easy cleaning.
- Empty tubs nest for space conservation.
- Full, lidded dump tubs stack securely for transporting, freezing and storing.
- Tubs meet all USDA specifications and are commonly used for meat, seafood, poultry, commercial fishing, confectionery, bakery and grain applications.
- Dimensions: 54-3/5 inches L x 32 inches W x 21-7/10 inches H. (36 inches high with regular undercarriage, 28 inches with low undercarriage).
- Capacity: 800 pounds.
- Color: white.



NOTE: Dump tub, lid and undercarriages all sold separately.

ITEM NO.	PRODUCT	SHIPPING WT.	F.O.B. FACTORY EACH
5281 6901	A. Dump Tub	28 lb.	\$369.89
5281 6902	B. Tub Lid	15 lb.	188.62
5281 6903	C. Regular Undercarriage	69 lb.	692.95
5281 6904	D. Low Undercarriage	105 lb.	680.84



Heavy-Duty Tilt Truck

Available in 16 custom colors.

- Durable polyethylene construction is highly dent- and crack-resistant.
- Free of cracks, crevices or joints which may harbor dirt and bacteria.
- Sturdy full perimeter black powder-coated steel underframe.
- Trucks are nestable for convenient storage.
- Industrial-quality, easy rolling casters are joined to the molding with sturdy bases.



MADE IN USA



Optional split-hinge lid available.

F.O.B. FACTORY

ITEM NO.	PRODUCT	COLOR	DIMENSIONS	CAPACITY	EACH
2345 0307	Tilt Truck	Gray	79-1/2" x 40-1/2" x 48-1/2"	2,000 lb/1.5-cu. yd.	\$999.00
2345 0308	Tilt Truck Split-Hinge Lid				\$373.48

41-1/2 inches deep.



Molded Plastic Utility Truck

Won't rust or corrode, won't splinter or dent, easy to clean.

- Domed, hinged lid conceals and protects loads without decreasing capacity.
- Metal frame design provides durable support.
- Diamond caster pattern is easy to maneuver.
- Color: black.

NOTE: More replacement parts available visit WWW.BUNZLPD.COM

Custom colors available in blue and brown.



MADE IN USA



ITEM NO.	PRODUCT	DIMENSIONS OD	CAPACITY	F.O.B. FACTORY EACH
1770 4607	8-cu. ft. Truck	36-2/5" x 26" x 28-1/4"	300 lb.	\$534.35
1770 4629	14-cu. ft. Truck	44-1/10" x 31" x 32-1/2"	500 lb.	748.45
1770 4621	16-cu. ft. Truck	44-1/2" x 31" x 37"	500 lb.	1,024.75
1770 03351	Lid for 8-cu. ft.	38-2/5" x 25-3/4" x 8-1/2"		278.35
1770 4628	Lid for 14 and 16-cu. ft.	44-1/10" x 31" x 8-1/2"		337.15

Replacement Parts

ITEM NO.	PRODUCT	EACH
3414 0049	Repl. 8 cu. yd. Metal Frame	\$125.95
3414 4613	Repl. 14 cu. yd. Metal Frame	145.95
3414 01001	Repl. 16 cu. yd. Metal Frame	195.95
3414 4608	Repl. 4" Rigid Caster (for 8 cu. yd. Truck).	35.95
3414 4607	Repl. 4" Swivel Caster (for 8 cu. yd. Truck).	39.95
3414 4615	Repl. 5" Rigid Caster (for 14/16 cu. yd. Truck)	39.95
3414 4614	Repl. 5" Swivel Caster (for 14/16 cu. yd. Truck)	43.95

Poly Tilt Truck

- Well balanced and easy to maneuver and tilt due to 12-inch load wheel and two rear swivel casters.
- Light-weight poly truck is easily transported and dumped by a single person.
- Smooth and seamless easy to clean interior.
- Poly trucks will not pit or corrode like steel.
- Color: black.

MADE IN USA

SPECIAL ORDER ITEM



NOTE: Hinged lid sold separately.

NOTE: Custom colors available. CALL FOR DETAILS.

Replacement Parts

ITEM NO.	PRODUCT	EACH
3414 1307	Repl. Black Frame (For 1/2-cu. yd. Truck)	\$542.11
3414 30541	Repl. Black Handle	119.90
3414 1305	Repl. 10" Wheel (For 1/2-cu. yd. Truck)	99.95
3414 0054	Repl. 3-1/2" Swivel Caster w/Hardware	48.03

ITEM NO.	PRODUCT	DIMENSIONS	CAPACITY	EACH
1770 1301	Tilt Truck	60-1/2" x 28" x 38.6"	850 lb/0.5 cu. yd.	\$935.00
1770 1321	Tilt Truck	72-1/4" x 33-1/2" x 43-3/4"	2,100 lb/1.0 cu.yd.	1,968.25
1770 13231	Lid			353.35





Single-Wall Poly Combo Bins

Lighter and less expensive than stainless steel.

- Two-way pallet entry. Fit two wide for maximum trailer cube.
- Seamless, easy-to-clean and corrosion-resistant.
- Heavy-duty roto-molded polyethylene bins are extra thick at corners and floor contact points.
- Custom identification can be molded-in or stenciled-on bins for an additional charge.
- Bins are nestable when empty and optional snug-fitting lids permit stacking when bins are full.



Molded stacking stops in each lid.



NOTE: Optional polyethylene dust cover is light-weight and non-stackable. Optional 1-1/2-inch bottom drain available. CALL FOR DETAILS.

F.O.B. FACTORY					
ITEM NO.	CAPACITY	CUBIC FT.	OUTSIDE DIMENSIONS	SHIPPING WT.	EACH
0021 0293	250 Gallon	.34	50" x 42" x 36"	100 lb.	\$1,613.83
0021 8294	275 Gallon	.37	50" x 42" x 39"	105 lb.	1,706.97
0021 8295	385 Gallon	.45	50" x 42" x 52"	125 lb.	1,800.46
0021 0296	Stacking Lid			35 lb.	719.00
0021 8297	Polyethylene Dust Cover			21 lb.	619.24
0021 0110	Rubber Drain Plug for Bins w/Drain				17.16



Poly Storage Combo Bins with Replaceable Pallet

- Double-thick base protects against damage to bottom.
- Top rim is reinforced for added protection from impact damage.
- Bins are nestable when empty and optional snug-fitting lids permit stacking when full.
- Optional polyethylene dust cover is light-weight and non-stackable.
- Fit two wide for maximum trailer cube. • Four-way entry, replaceable pallet.



NOTE: Optional bottom drain available.

Flat-bottom makes cleaning quick and easy with no cavities for bacteria to grow.



F.O.B. FACTORY

ITEM NO.	CAPACITY	CUBIC FT.	OUTSIDE DIMENSIONS	SHIPPING WT.	EACH
0021 5304	225 Gallon	.34	50" x 42" x 36"	108 lb.	\$2,143.81
0021 5305	250 Gallon	.37	50" x 42" x 39"	113 lb.	2,285.12
0021 5302	360 Gallon	.45	50" x 42" x 52"	135 lb.	2,510.97
0021 5307	400 Gallon	.45	50" x 42" x 55"	140 lb.	2,552.75
0021 5309	Stacking Lid			35 lb.	695.88
0021 5310	Polyethylene Dust Cover			21 lb.	619.24
0021 5308	Replacement Pallet			35 lb.	722.43



Removable pallet can be easily replaced if damaged.

MonsterCombo® Bins

Versatile, multi-use bulk containers are ideal for in-plant processing, food handling or over-the-road hauling capacities.

- Rotationally molded FDA-CFIA approved polyethylene.
- Replaceable 4-way base with smooth flat interior is easy to clean.
- Standard footprint: 48 inches x 44 inches. Available in heights from 36 inches to 45 inches.
- Extra thick at corners and floor to resist impact and wear and reinforced top edge adds strength and resists splitting.
- Nest bins when empty to save storage space.
- Four-way fork lift and pallet jack entry.



Smooth flat interior is easy to clean.



NOTE: Optional bottom drain available.



F.O.B. FACTORY					
ITEM NO.	CAPACITY	CUBIC FT.	OUTSIDE DIMENSIONS	SHIPPING WT.	EACH
0021 2902	229 Gallon	.31	48" x 44" x 36"	132 lb.	\$2,243.81
0021 2962	251 Gallon	.34	48" x 44" x 39"	139 lb.	2,257.73
0021 2910	273 Gallon	.37	48" x 44" x 42"	152 lb.	2,280.63
0021 2963	296 Gallon	.40	48" x 44" x 45"	153 lb.	2,267.55

NOTE: Custom colors available. CALL FOR DETAILS.

Stainless Steel Vat



- Heavy-duty welded, 12-gauge stainless steel construction with rolled and welded rim.
- Interior welds are ground smooth for easy cleaning.
- 7-inch legs are constructed of 11-gauge stainless steel and are completely closed to meet USDA requirements.
- 1-1/2-inch drain constructed into vat, plug not included.
- Capacity: 2,000 pounds.
- Dimensions:
Outside: 39 inches L x 51 inches W x 43 inches H.
Inside: 36 inches L x 47-1/2 inches W x 36 inches H.



NOTE: Optional drain plug available. SEE BELOW.

F.O.B. FACTORY

ITEM NO.	PRODUCT	SHIPPING WT.	EACH
2990 1619	Vat	250 lb.	\$5,281.65

Aero-Tote Container



High-density polyethylene walls offer protection for all kinds of food products.

- Lid made of thick, rigid polyethylene allowing for column stacking.
- Versatile modular design allows for secure nesting, stacking and in-plant moving with a forklift.
- Pallet easily snaps on and off.
- Ribbed bottom for drainage.



Totes stacked.



Totes nesting.

NOTE: Tote, lid and pallet all sold separately.

F.O.B. FACTORY

ITEM NO.	PRODUCT	OUTSIDE DIMENSIONS	SHIP WT.	EACH
5281 6921	Aero-Tote Tub	36" x 40" x 21-1/10"	22 lb.	\$311.59
5281 69251	Aero-Tote Tub w/Drain Plug	36" x 40" x 21-1/10"	22 lb.	333.85
5281 6922	Aero-Tote Lid	36-1/2" x 41" x 2"	13 lb.	178.02
5281 6923	Aero-Tote Pallet	32-7/10" x 37-1/5" x 9-1/2"	20 lb.	222.55

1-1/2-Inch Rubber Drain Plug for Stainless Vats



ITEM NO.	PRODUCT	EACH
3994 2606	1-1/2" Drain Plug	\$3.16

Metal Detectable 1-1/2-Inch Drain Plug for Stainless Vats



ITEM NO.	PRODUCT	EACH
3994 60081	1-1/2" Drain Plug	\$4.25

Laundry Truck

Uniquely designed to hold bulk fabrics and linens.



- Durable polyethylene construction is highly dent- and crack-resistant.
- Free of cracks, crevices or joints which may harbor dirt and bacteria.
- Industrial quality, easy rolling casters are jointed to the molding with sturdy bases.
- 48 cubic foot capacity; 59 inches deep.
- Dimensions: 48 inches L x 28-1/2 inches W x 66-1/2 inches H.
- Easy to clean and sanitize.
- Shipping weight: 127 pounds.



F.O.B. FACTORY

ITEM NO.	PRODUCT	EACH
2345 0072	Laundry Truck	\$799.00

▶ SEE PAGE 85

FOR LAUNDRY DETERGENT AND PINS





10-high maximum stacking.

MACX™ Storage System

The durability and versatility of steel for the cost of plastic.

- Light-weight • Strong • Durable • Stackable



Standard MACX™ Bins

Light-weight, yet strong enough to hold 1,500 pounds of product.

- One-piece, injection molded construction. • 25.4 cubic feet; 190 US gallons.
- Made from high-density, food-grade structural plastic with a service life comparable to steel.
- Will not warp, dent, chip, splinter, rot or rust and are chemical and corrosion-resistant.
- Withstands temperatures from -32 °F to 165 °F. • Capacity: single bin, unstacked, static weight of 1,500 pounds.
- Completely sanitary: can be high-pressure washed and steam sterilized. • Shipping weight: 89 pounds.
- Drain and cap are available for liquid applications. • 48 inch x 40 inch standard pallet footprint.

NOTE: Customizable: add casters, drain plugs, label holders, drop doors, attachable lids, custom colors and even emboss your company logo on the side. CALL FOR MORE INFORMATION.



31" Outside

MACX™ come standard with runners — easy for dumping or moving with a forklift.

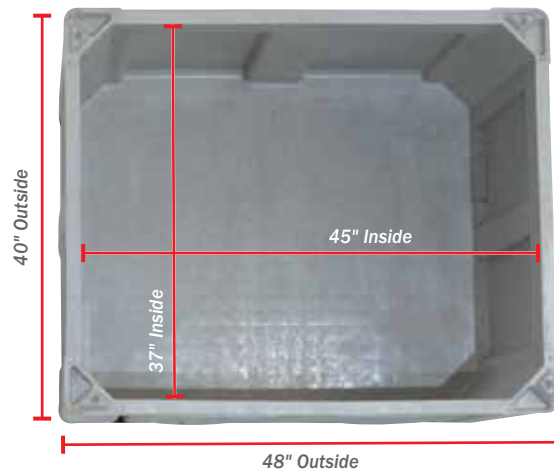

40" Outside

37" Inside

45" Inside

48" Outside



Smooth interior can easily be high-pressure washed and sterilized. Meets USDA/HACCP standards for food handling.

ITEM NO.	PRODUCT	F.O.B. FACTORY EACH
3515 5732	Storage Bin, Solid, Gray	\$317.95
3515 5736	Storage Bin, Solid, White.	338.95
3515 0052	Storage Bin, Vented, Gray.	263.95
3515 5862	Stacking Lid, White	99.95
3515 5863	Drain and Cap Kit (For DIY Installation)	42.95



Optional drain and cap kit.

Collapsible KitBins

All the benefits of the standard MACX™ bin, but with greater space efficiency.

- Engineered from maintenance-free, high-impact resistant HDPE structural foam for the highest strength-to-weight ratio.
- Removable walls provide easy access for loading and unloading.
- Withstands temperatures from -40 °F to 140 °F. Resists UV degradation.
- Solid or vented wall options. Panels are interchangeable.
- Stackable up to 6 units high. • Four-way forklift entry.
- External Dimensions: 40 inches L x 48 inches W x 28 inches H. Internal Dimensions: 36 inches L x 4 inches W x 23 inches H. Pallet Dimensions: 48 inches x 40 inches. Side Panels: 48 inches x 28 inches and 40 inches x 28 inches.
- Capacity: maximum weight load 1,320 pounds.
- Volume: 163 gallons/20 cubic feet. • Replacement sides available.
- Shipping weight: 84 pounds.



Four disassembled containers fit into one bin, saving up to 75% trailer or storage space.

F.O.B. FACTORY
EACH

ITEM NO.	PRODUCT	F.O.B. FACTORY EACH
3515 0100	Collapsible Bin, Solid Gray	\$409.65
3515 1100	Collapsible Bin, Vented Gray	409.65
3515 0010	Stacking Lid, White	100.15



All walls can be completely detached from the pallet, providing easy access for loading and unloading.



Posts securely lock sides together for a sturdy container even during transport.

NEED ASSISTANCE?



Our experienced customer service representatives are available to answer your questions, find the products you are looking for, check product availability, as well as take your order.

800-456-5624

Combo Cap Cover

Attach a combo cap cover over the top of your box to keep contents inside dust and particle free.

- 0.85 mil, clear boxed rolls.

NOTE: We recommend securing cap covers using liner bands, sold separately. SEE BELOW.



Liners come packaged on rolls inside a cardboard box.



▶ 250 PER ROLL - 25 ROLLS PER PALLET.

ITEM NO.	PRODUCT	DIMENSIONS	ROLL
H610 4513	Clear Cap Cover	54" x 44" x 36"	\$167.75

Heavy-Duty Drum Liner

- 2.5 mil. • Color: clear.
- 38 inches x 60 inches.

ITEM NO.	PRODUCT
E539 3860	38" x 60"

▶ 125 LINERS PER ROLL

ROLL
\$196.85



Combo Poly Liners

- Increased differential slip allows for easy opening of liners every time.
- For use with cardboard combo bins.
- 2 mil polyethylene.
- Plastic liner keeps food products from coming into contact with cardboard shipping containers.

▶ 25 LINERS PER ROLL

ITEM NO.	PRODUCT	ROLL
E539 0128	54" x 44" x 78"	\$122.16
E539 0115	54" x 44" x 87"	144.31
E539 0129	54" x 44" x 96"	161.00



Combo Liner Bands

- Use liner bands to secure combo liners and combo cap covers.
- Reusable bands are quickly applied or removed.

▶ 50 PER BAG - 4 BAGS PER CASE

ITEM NO.	PRODUCT	BAG
B405 3073	Combo Liner Bands	\$73.45

NOTE: Other sizes and gauges of combo liners available. CALL FOR MORE INFORMATION.



Built-in stops keep the ramp from sliding and secures it firmly in place.

Cooler/Curb Ramp

- Ideal for carts, dollies and hand trucks being used in food service and cooler applications.
- Constructed of heavy-duty, light-weight aluminum with slip-resistant strips.
- Molded edging keeps truck from rolling off side of ramp.
- Dimensions: 27 inches x 27 inches.

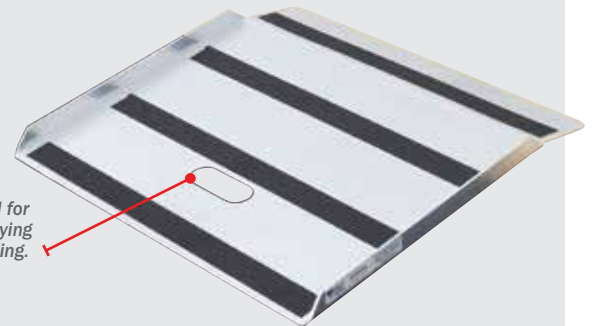

Handhold for easy carrying and hanging.

ITEM NO.	PRODUCT	CAPACITY	EACH
3775 0172	Cooler Ramp	750 lb.	\$282.23

Molded Plastic Freezer Spacer

- Unique design features holes throughout to decrease freezing times.
- Raised nubs along the edge keep boxes from sliding off.
- Shipping weight: 4-1/5 pounds, 2,000 pound capacity.
- Shipping weight: 4-2/5 pounds, 3,000 pound capacity.

▶ 500 PER PALLET.

ITEM NO.	PRODUCT	DIMENSIONS	CAPACITY	EACH
K188 00011	Freezer Spacer . . .	40" x 48"	2,000 lb	\$16.95

▶ 400 PER PALLET.

ITEM NO.	PRODUCT	DIMENSIONS	CAPACITY	EACH
2992 3818	Anti-Slip Spacer. . .	40" x 48"	3,000 lb	\$20.00

▶ 300 PER PALLET.

ITEM NO.	PRODUCT	DIMENSIONS	CAPACITY	EACH
2992 4840	w/o Anti Slip.	40" x 48"	3,000 lb	\$21.89



Chipboard Tier Sheets

- Use for shipping, palletizing and dividing stacked product.



ITEM NO.	DIMENSIONS	CASE
B044 4400	37" x 44" x 0.011"	\$525.94
B044 4725	40" x 47-1/4" x 0.012"	600.70

SIGN UP FOR OUR eDEALS

Get exclusive offers not found anywhere else!

www.bunzlpd.com

Slipsheets

Designed to supplement wood pallets in transportation and warehouse applications — reduce unloading time by 50%!

- Choose from: laminated, patterned top surface (A) or dimpled top surface from sliding (B).
- High-density polyethylene slipsheets are resistant to moisture, chemicals, heat and cold.
- Maintains strength and integrity even when wet.
- Bottom surface allows the sheet to slide more easily for enhanced handling.
- Manufactured from recycled plastic. • 100% recyclable. • Color: black.

A. Patterned Top Surface

▶ 1,000 PER PALLET - SOLD BY PALLET ONLY.

ITEM NO.	DIMENSIONS	F.O.B. FACTORY	
		PALLET	EACH
1613 10251	54" x 40" x 0.025"	\$3,910.00	\$3.91
1613 42401	42" x 40" x 0.025"	3,910.00	3.91
1613 51251	51" x 43" x 0.025"	5,940.00	5.94
1613 54251	51" x 46" x 0.025"	5,230.00	5.23

B. EZ Grab Loadloc®

▶ 1,000 PER PALLET - SOLD BY PALLET ONLY.

ITEM NO.	DIMENSIONS	F.O.B. FACTORY	
		PALLET	EACH
1613 20181	40" x 54" x 0.025"	\$3,910.00	\$3.91
1613 61881	43" x 51" x 0.025"	5,230.00	5.23

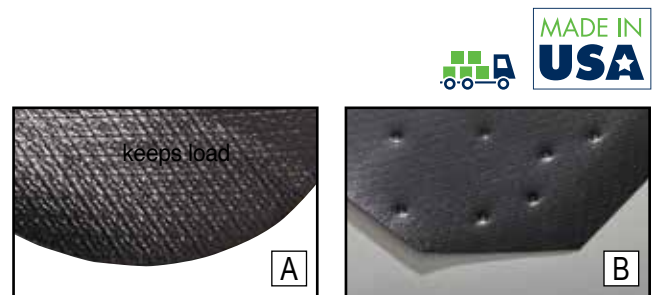

Palletote™ Shipping Containers

180° stack/nest shipping boxes.

- Durable, reusable boxes are ideal for shipping and many in-process material handling jobs.
- Made with USDA 3A (dairy) Sanitary Standards and Meat and Poultry Equipment Group Listed.
- Materials are FDA-compliant for food contact and certified to NSF 2 Standards.
- Injection-molded polyethylene for uniform wall thickness.
- Nestable or stack with lids.
- Recommended operating temp: -10 °F to 130 °F.
- Easy to clean.
- Color: gray.

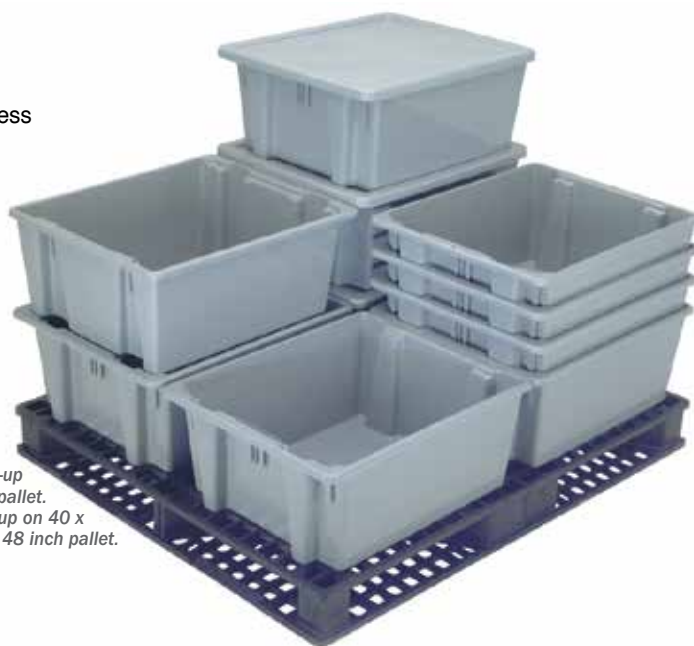

Standard box: OD fits 6-up
on 40 x 48 inch pallet.
Large box: OD fits 4-up on 40 x
48 inch pallet.

MADE IN
USA

NSF



► 10 PER CASE.

ITEM NO.	PRODUCT	DIMENSIONS	EACH
1770 73241	Standard Box	19-1/2" x 15-1/2" x 10"	\$29.55
1770 47061	Standard Lid		27.75
1770 73301	Large Box	23-1/2" x 19-1/2" x 10"	37.85
1770 73281	Large Lid		30.95

Decade KitBin® Color Pallets

Perfect for food processing applications.

- Single-piece, high-density polyethylene construction stands up to heavy loads and continuous use.
- Easy-to-clean smooth surfaces have no splinters or wood chips.
- Up to 4,000 pounds dynamic load; up to 13,200 pounds static load.
- Available in gray, yellow, green or blue.
- Shipping weight: 41 pounds.
- Dimensions: 48 inches L x 40 inches W x 5-9/10 inches H.

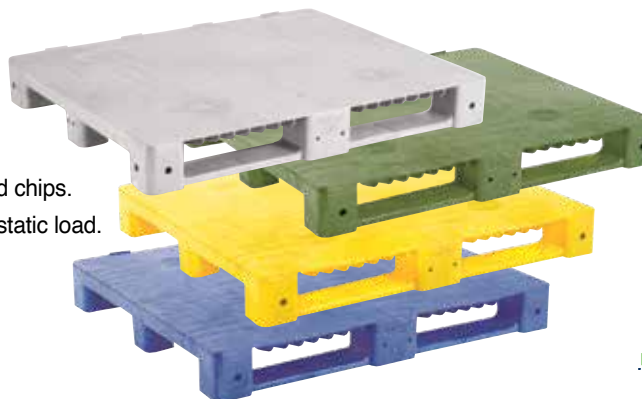

ITEM NO.	COLOR
3515 9201	Gray
3515 9202	Yellow
3515 9203	Green
3515 9901	Blue

F.O.B. FACTORY



EACH
\$166.25

Decade RACX® Pallets

- Fabricated of recycled HDPE plastics, these rackable pallets feature a picture frame bottom with runners on all four sides for stability.
- Ideal for use in warehouse racking systems, as well as stack loading, closed loop transport, floor storage and automated material handling applications.
- RACX® Pallets may be fitted with optional rubber grommets or lip to keep contents from slipping.
- Dimensions: 48 inches L x 40 inches W x 6-1/10 inches H.
- Shipping weight: 35 pounds.



F.O.B. FACTORY
EACH

ITEM NO.	COLOR	EACH
3515 4856	Black	\$71.95
3515 4857	Blue	128.65
3515 0032	Red	128.65
3515 0033	Green	128.65

Floor Static Load Capacity = 25,000 pounds
Fork Dynamic Load Capacity = 5,000 pounds
Racking Load Capacity = 2,200 pounds

Open Foot Nestable Pallets

Open foot design allows waste to easily exit the bottom of the pallet.

- Nestable/stackable pallets are constructed of heavy-duty, single-piece molded polyethylene that meets USDA/FDA requirements.
- Catch points have been minimized for improved sanitation of the pallet.
- Grooved, easy to clean, slip-resistant decks.
- Four-way entry allows convenient lifting by forklift.
- Rated for temperatures to -30 °F.
- 100% recyclable.

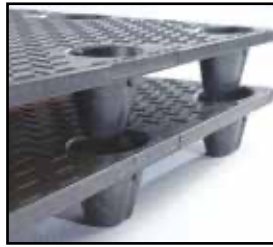

Floor Static Load Capacity = 30,000 pounds
Dynamic Load Capacity = 4,000 pounds



F.O.B. FACTORY

ITEM NO.	PRODUCT	DIMENSIONS	SHIPPING WT.	EACH
A005 4840	I-Nest Pallet	48" x 40" x 6"	27 lb.	\$124.65

Aluminum Tube Frame Pallet, 5,000 Pound Capacity

Perfect for food processing applications.

- Sealed tube, all welded aluminum construction.
- Fireproof. • Recyclable. • Metal Detectable.
- Base: 3/4 inch x 3-3/8 inch tube construction.
- Risers: 2 inch x 2 inch x 0.2175 inch wall tubing.
- Dimensions: 40 inches x 48 inches x 5-1/4 inches.



Floor Static Load Capacity = 30,000 pounds
Dynamic Load Capacity = 5,000 pounds
Rackable Load Capacity = 5,000 pounds

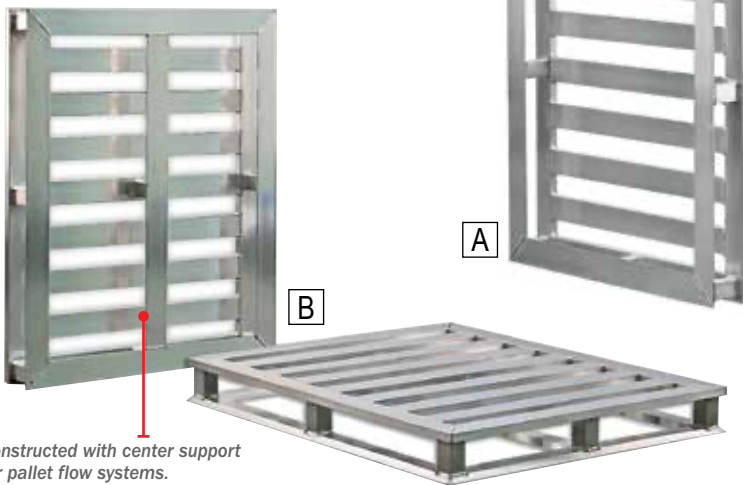

Constructed with center support for pallet flow systems.

F.O.B. FACTORY

ITEM NO.	DIMENSIONS	SHIPPING WT.	EACH
3775 0013	A. Perimeter Base48 lb.	\$497.72
3775 0011	B. Perimeter and Center Base51 lb.	514.79

Aluminum Pallet Mover

- For transporting 40-inch x 48-inch pallets.
- Ergonomic push handle for ease of movement.
- Floor lock on dolly securely keeps dolly in place.
- 6-inch x 2-inch polyurethane casters — 2 swivel with brakes and 2 rigid.



F.O.B. FACTORY
EACH

ITEM NO.	PRODUCT	EACH
3775 0068	Aluminum Pallet Mover	\$1,136.06

Pallet Truck, 5,500 Pound Capacity



- 3 mm thick adjustable connecting forks.
- Overload bypass. • Rubber coated handle.
- Entry and exit rollers. • 210° steering.
- Some assembly required.
- 7-inch moldon polyurethane steering wheels. 3-inch moldon polyurethane load wheels.
- Shipping weight: 194 pounds.



ITEM NO.	DIMENSIONS	EACH
7447 3448	27" x 48"	\$1,142.66

SHOP 24/7
bunzlpd.com



Need Help?
 Chat With Us
 Online!

STAY CONNECTED WITH US:



Ergo Stands

Help level the height difference among workers at shared workstations — creating a comfortable, ergonomic working position.

- Punched anti-slip deck for maximum traction reduces slips and falls from wet or slippery floors.
- Constructed of solid, fully welded rust-free aluminum.
- Available in 5 heights.

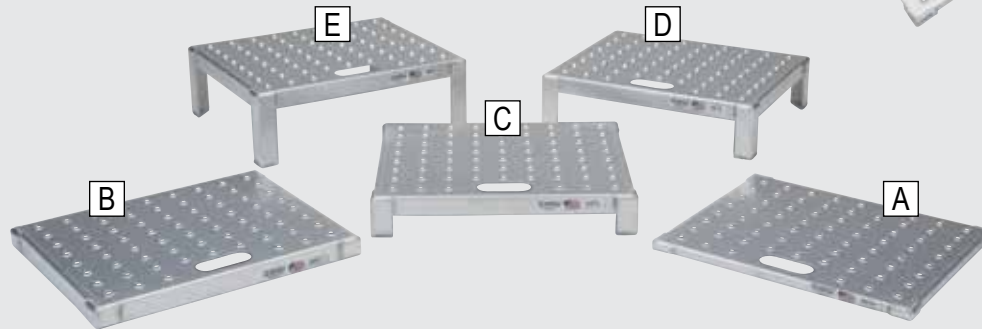

Anti-slip deck for maximum traction.

Handhold for easy carrying and hanging.



ITEM NO.	PRODUCT	DIMENSIONS	SHIPPING WT.	EACH
3775 00861	A. 1" Ergo Stand	24" x 20" x 1"	10 lb.	300.08
3775 00891	B. 2" Ergo Stand	24" x 20" x 2"	11 lb.	310.13
3775 00881	C. 4" Ergo Stand	24" x 20" x 4"	12 lb.	329.96
3775 00871	D. 6" Ergo Stand	24" x 20" x 6"	13 lb.	340.07
3775 0090	E. 8" Ergo Stand	24" x 20" x 8"	14 lb.	349.86

Aluminum Mobile Dunnage Rack

Transport and store merchandise without having to load or unload.

- Optional tow hook and optional handle available for easier transport.
- Fully washdown and corrosion-resistant.
- 5-inch casters — 2 swivel with brakes and 2 rigid.
- 6-inch x 2-inch polyurethane casters — 2 swivel with brakes and 2 rigid.

NOTE: Optional tow hook or handle, sold separately.



Optional tow hook can be inserted under or over loop.



F.O.B. FACTORY EACH

ITEM NO.	PRODUCT	DIMENSIONS	EACH
3775 0066	Aluminum Mobile Dunnage Rack	20" x 8-1/4" x 49-3/4"	\$464.97
3775 00671	Aluminum Tow Hook	37"	31.43
3775 2862	"Drop-In" Handle	22" x 35"	59.10

Plastic Dunnage Racks

- Keep frozen, cold or dry inventory 12 inches safely off the floor.
- One-piece, heavy-duty polypropylene construction is easy to clean.
- Will not rust, corrode or bend.
- Slotted tops for maximum air circulation around perishable products.



NOTE: Includes one Camlink Connector to securely lock multiple racks together.



ITEM NO.	DIMENSIONS	CAPACITY	SHIPPING WT.	EACH
2432 0081	36" x 21" x 12"	1,500 lb	20 lb.	\$674.00
2432 7017	48" x 21" x 12"	3,000 lb	30 lb.	814.00
2432 0067	60" x 21" x 12"	3,000 lb	33 lb.	327.70

Aluminum Dunnage Racks

- Ideal where supplies must be stored off the floor.
- No openings or crevices to trap dirt.
- Corrosion resistant, all welded and easy to keep clean.
- Made entirely of 1-1/2-inch x 1-3/4-inch extruded aluminum.



ITEM NO.	DIMENSIONS	CAPACITY	SHIPPING WT.	EACH
3775 2131	36" x 20" x 12"	3,000 lb	.9 lb.	\$157.57
3775 2132	48" x 20" x 12"	2,500 lb	.11 lb.	171.88
3775 2133	60" x 20" x 12"	2,000 lb	.14 lb.	185.13
3775 2139	36" x 20" x 8"	3,000 lb	.9 lb.	157.57
3775 2138	48" x 20" x 8"	2,500 lb	.11 lb.	172.09
3775 2137	60" x 20" x 8"	2,000 lb	.14 lb.	185.02

Aluminum Nesting Racks

- Heavy-duty, all welded construction. • Height: 12 inches.



NOTE: Optional space saving bridge, joins racks to accommodate tight spaces.



ITEM NO.	DIMENSIONS	CAPACITY	SHIPPING WT.	EACH
2510 2024	20" x 12" x 24"	3,000 lb	.8 lb.	\$100.45
2510 2036	20" x 12" x 36"	2,500 lb	.9 lb.	114.65
2510 2048	20" x 12" x 48"	2,000 lb	.17 lb.	125.95
2510 2025	20" x 24" Bridge - Span Limit 8" to 18"		4 lb.	60.45



FREE GROUND SHIPPING

when you place an order for \$500 or more from THIS BUYERS GUIDE!

*FREE SHIPPING does NOT include UPS Next Day Air, UPS 2nd Day or UPS 3rd Day Select. Certain items may not qualify. This offer is good only on orders shipped UPS Ground in the 48 contiguous states. Based on dimensional weight, we will determine the most efficient means of shipment, either UPS or LTL. Products may ship by truckline.

Solid Aluminum Wall Shelves

Ideal for maximizing storage space in your workplace or plant.

- 18-gauge shelves are constructed of 0.04 inch aluminum, 12-gauge shelves are constructed of 0.08 inch aluminum.
- Solid strip brackets give you the flexibility to install the shelving in two different ways.
- Shelves will not rust or corrode.

ITEM NO.	SIZE	CAPACITY	GAUGE	EACH
3775 06751	12" x 24"	200 lb.	.18	\$81.36
3775 11251	12" x 36"	150 lb.	.18	120.79
3775 11261	12" x 48"	125 lb.	.18	132.66
3775 11271	12" x 60"	100 lb.	.18	150.89
3775 56341	18" x 24"	300 lb.	.12	157.57
3775 20931	18" x 36"	300 lb.	.12	166.79
3775 20941	18" x 48"	225 lb.	.12	213.96
3775 41361	18" x 60"	150 lb.	.12	240.25



Above the shelf where brackets can act as bookends.

NOTE: Mounting hardware NOT INCLUDED.



Or with the brackets below the shelf.



For Locks ▶ SEE PAGE 280

Modular Storage Cabinets

Sturdy, molded plastic modular storage cabinets will not rust in wet environments.

- Simple snap-together assembly.
- Resistant to moisture, dents and common chemicals.
- Interior shelves hold up to 180 pounds and adjust every 2 inches.
- Full cabinet features 4 shelves and the base cabinet has 2 shelves.
- Dimensions:
Base Cabinet (A): 36 inches x 18 inches x 36 inches.
Full Cabinet (B): 36 inches x 18 inches x 72 inches.



NOTE: Can be padlocked for added security. Padlocks sold separately.



ITEM NO.	PRODUCT	SHIP WT.	EACH
1770 7085	A. Base Cabinet	36" x 18" x 36"	\$229.15
1770 7083	B. Full Cabinet.	36" x 18" x 72"	343.75

Nexelite™ Solid Plastic Shelving

- Unit consists of 4 solid plastic shelves and 4 posts.
- Raised lip around edge of shelf prevents spills from overflowing.
- Shelves made of durable, rust and stain-resistant plastic that cleans with ease. Honeycomb bottom adds strength and rigidity to the unit.
- Each shelf has a load capacity of 300 pounds.
- Dimensions: 48 inches x 24 inches x 63 inches.



Posts constructed of chemical, acid, abrasion and corrosion-resistant Nexelon™ and allow shelves to be adjusted in 1 inch increments.



Level with just a twist of the wrist. Adjust loaded shelves with just an open-end wrench.

ITEM NO.	PRODUCT	EACH
5268 4486	Four Shelf Unit and Posts	\$449.95
5268 0061	63" Replacement Posts	21.95



Adjustable Aluminum Shelving

- Light-weight and durable, heavy-duty, all-welded aluminum tubing.
- Mix shelf styles on each unit to maximize storage.



ADJUSTABLE ALUMINUM SHELVING

CUSTOMIZE FOR YOUR APPLICATION — Just Order The Components You Need:

- 1. Uprights:** Start with four 68-inch uprights (see item# 3775 3916 BELOW).
- 2. Shelves:** Pick 4 or more shelves which fit your application. Choose from solid, close center or heavy-duty AS SHOWN BELOW.
- 3. Casters:** Add the optional caster kit for mobile shelf truck conversion. (Includes four, 5-inch black polyolefin wheels with 1-inch swivel, stem-type casters, each with locking brake.)



Scan this QR code with your mobile device to view a video of the features of adjustable aluminum shelving.



Shelves are easily assembled with 5/16-inch Allen wrench.



The mobile shelf unit shown here uses solid 20-inch x 36-inch shelves. (Item# 3775 4403)



Caster Kit, Optional

For this shelving unit ONLY.



ITEM NO.	PRODUCT	EACH
0844 39005	Four Caster Kit.	\$107.88

Close Center Shelves

- Maximum strength and air circulation.
- 1-inch x 1-1/2-inch T-bars are welded on 2 inch centers.
- Durable 1-1/2-inch x 1-3/4-inch frame.
- Load capacity per shelf: 1,000 pounds.
- Unit load capacity with caster conversion: 700 pounds.



F.O.B. FACTORY

ITEM NO.	PRODUCT	SHIP WT.	EACH
3775 4162	20" x 36" 9 lb.		\$148.45
3775 4163	20" x 48" 12 lb.		170.71
3775 4164	20" x 60" 14 lb.		185.02
3775 4165	20" x 72" 17 lb.		223.18
3775 3916	Upright, 68" . . . 4 lb.		43.30

Economy Solid Shelves

- Solid 0.040-inch aluminum sheet.
- Double-thick, raised marine edge.
- Contains spills and makes clean-up easier.
- Load capacity per shelf: 400 pounds.
- Unit load capacity with caster conversion: 700 pounds.



F.O.B. FACTORY

ITEM NO.	PRODUCT	SHIP WT.	EACH
3775 4403	20" x 36" 5 lb.		\$160.11
3775 4404	20" x 48" 6 lb.		166.79
3775 4405	20" x 60" 7 lb.		170.71
3775 4406	20" x 72" 8 lb.		179.83
3775 3916	Upright, 68" . . . 4 lb.		43.30

Heavy-Duty Shelves

- Ideal for large, bulky items that need superior air circulation.
- Load capacity per shelf: 1,500 pounds.
- Unit load capacity with caster conversion: 700 pounds.



F.O.B. FACTORY

ITEM NO.	PRODUCT	SHIP WT.	EACH
3775 3912	20" x 36" 8 lb.		\$128.63
3775 3913	20" x 48" 10 lb.		143.05
3775 3914	20" x 60" 12 lb.		157.57
3775 3915	20" x 72" 14 lb.		185.02
3775 3916	Upright, 68" . . . 4 lb.		43.30

Heavy-Duty Wire Shelving

Rustproof, green epoxy coating is applied over a zinc-chromate finish and will stand up to years of harsh conditions.



Shelves feature an open heavy-gauge wire design allowing greater air circulation and improving visibility of stored items.

► SEE PAGES 206 and 248
Food Boxes and Food Containers Sold Separately.

Holds up to 2,400 pounds!
Recommended weight distribution: 800 pounds max per lower shelves and 400 pounds max per upper shelves.
Load capacity with casters is 500 pounds total.



ITEM NO.	PRODUCT	EACH
3419 49681	18" x 24" Shelves	\$32.45
3419 49691	18" x 36" Shelves	37.95
3419 49701	18" x 48" Shelves	46.65
3419 49711	18" x 60" Shelves	61.95
3419 49721	18" x 72" Shelves	70.65
3419 49731	24" x 36" Shelves	49.95
3419 49741	24" x 48" Shelves	63.05
3419 49751	24" x 60" Shelves	76.05
3419 49761	24" x 72" Shelves	84.85
3419 49791	36" Post (comes as 12 piece)	14.15
3419 49781	72" Post (comes as 2 pieces)	20.65
3419 49771	"S" Clip	4.35
3419 4100	Replacement Shelf Clips, 4/Bag	4.35
4804 0000	Caster Kit, 4 Casters	86.95

THE SECRET Behind the Strength



- 3-wire truss all-welded design makes it a dozen times stronger than a solid steel truss of the same weight.

EASY, NO-TOOLS ASSEMBLY!



- Screw the post together, snap the sleeve onto the desired indexing groove and drop the shelf's collar over it.

- Numbered posts for easy assembly.

- Adjust shelves at 1 inch increments along the entire length of the post.



- Combine different depth shelves to jog around wall protrusions, run-around corners, etc.



- Connect multiple units together with our "S" clips for increased rigidity and storage space.



LEVELING IS A BREEZE!



- Level with just a twist of the wrist.

- Adjust loaded shelves with an open-end wrench.

- For mobility, replace the levelers with a caster kit.

- Leveling bolt: 3/8" x 16 tpi.

CASTER KIT

Move your shelving easily by replacing levelers with casters. Each caster kit contains four, 5-inch casters (2 with locks and 2 without locks) and four easy-to-install adapter sleeves that better reinforce the legs of the shelving structure and allow the casters to fit securely over them. These unique sleeves keep the legs from bending on loads totaling up to 500 pounds.

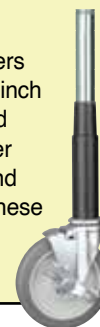

BUILD YOUR OWN 18-inch x 24-inch Four Shelf Unit ONLY \$191.60

ITEM NO.	QTY.	PRODUCT	
3419 49681	4	18" x 24" Shelves	\$129.80
3419 49781	4	72" Vertical Posts	82.60
Add a caster kit (4804 0000) for mobility + \$79.95			\$212.40

CALL 800-456-5624 for more information and to place your order

Stainless Steel Sausage Truck

- Heavy-duty 14-gauge, type 304 stainless steel truck body, continuously welded for added strength and sanitation.
- A solid rod reinforces the exclusive welded rim. • Large center load wheels allow truck to turn in tight spaces.
- Reinforced understructure supports casters easily.



MADE IN USA

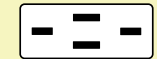
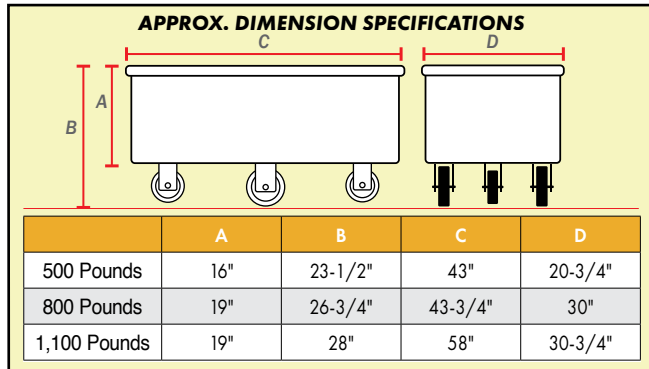

Standard wheel configuration for 500- and 800-pound trucks — four rigid.

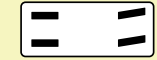

Standard wheel configuration for 1,100 pound trucks — two rigid and two swivel.

ITEM NO.	PRODUCT	SHIPPING WT.	EACH
2990 4988	500 lb Capacity SS Sausage Truck	78 lb	\$1,946.95
2990 4990	800 lb Capacity SS Sausage Truck	106 lb	2,839.65
2990 5388	1,100 lb Capacity SS Sausage Truck	145 lb	3,568.05

EasyRol Sausage Truck

14-inch center load wheel for easier maneuvering over uneven surfaces, even with heavy loads.

- Solid stainless steel construction with smooth seams. • Fully welded inside and out.
- Truck body is continuously welded for added strength and sanitation. • Replacement wheels available.
- Drain and cap for easy cleaning. • Heavy-duty 14-gauge, type 304 stainless steel.



MADE IN USA

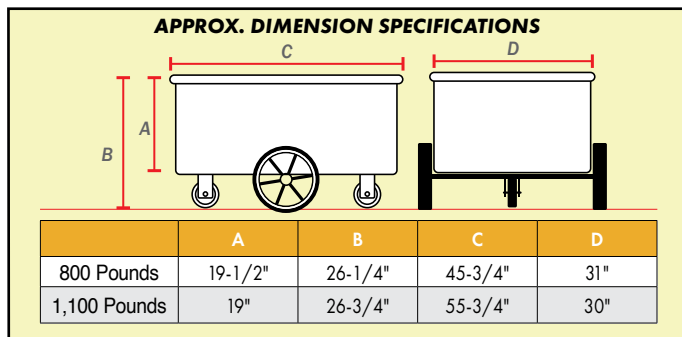

ITEM NO.	PRODUCT	SHIPPING WT.	EACH
2990 2988	800 lb Capacity EasyRol Sausage Truck	180 lb	\$3,780.35
2990 2989	1,100 lb Capacity EasyRol Sausage Truck	200 lb	3,943.35

Stainless Steel Elevated Truck

Ergonomic "Back Saver" design for easy loading/unloading.

- New channel leg construction.
- Ergonomic working height. • Solid stainless steel construction with smooth seams.
- Fully welded inside and out. • Heavy-duty 14-gauge, type 304 stainless steel.
- 5-inch x 2-inch black poly wheels: 2 rigid - 2 swivel. • Shipping weight: 94 pounds.



MADE IN USA

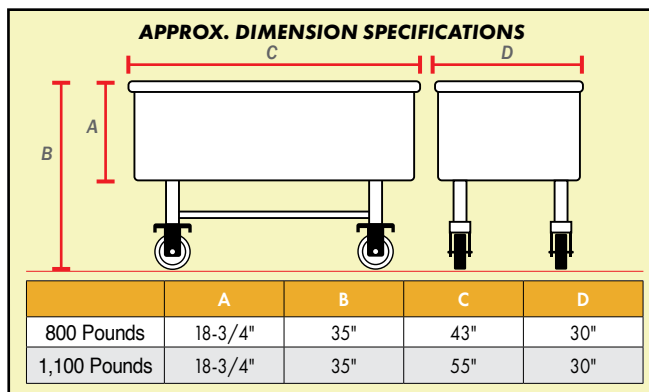

ITEM NO.	PRODUCT	EACH
2990 0190	800 lb Capacity SS Elevated Truck	\$3,270.50
2990 0191	1,100 lb Capacity SS Elevated Truck	3,904.68

Stainless V-Edge Dump Buggies

Smooth seams make it easy to wash.

- Choose from solid 1 inch rolled or flat bar rim welded v-edge.
- Heavy-Duty T-304 stainless steel construction with smooth seams.
- Standard stainless steel lifting lugs and closed-end drip guards meet USDA standards.
- Equipped with 2-inch x 6-inch white poly wheels, replaceable Delrin spinner bushings with greaseable zerk axles.
- Interior Dimensions: 400 pounds — 21 inches L x 24 inches W x 20 inches H; 600 pounds — 21 inches L x 24 inches W x 30 inches H.



DIMENSION SPECIFICATIONS

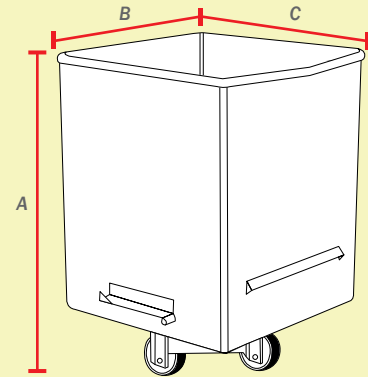

	A	B	C
2990 4528	28"/20" ID	28"/23.5" ID	28"/24.5" ID
2990 4529	38"/30" ID	28"/23.5" ID	28"/24.5" ID
2990 4251	38"/30" ID	28"/23.5" ID	32"/24.5" ID
2990 1150	38"/30" ID	28"/23.5" ID	28"/24.5" ID

ITEM NO.	PRODUCT	EDGE	CAPACITY	SHIP WT.	EACH
2990 4528	V-Edge Buggy	Rolled Rim	400 lb.	77 lb.	\$1,105.71
2990 4529	V-Edge Buggy	Rolled Rim	600 lb.	97 lb.	1,309.91
2990 4251	V-Edge Buggy w/Handle	Rolled Rim	600 lb.	97 lb.	1,369.13
2990 1150	V-Edge Buggy	Flat Bar Rim	600 lb.	97 lb.	1,407.97
3502 98241	Optional V-Edge Buggy Lid				36.95
0844 2225	Replacement Wheel				14.92
0844 2229	Replacement Bushing (Stainless Steel)				15.48
0844 20311	Replacement Zerk Axle				12.85

EZ-Way Knock-Down BuggyWash™

- Heavy-duty welded, stainless steel.
- Helps to reduce back strain and injury.
- Stainless steel construction won't rust.
- Use with lifting lugs up to 28-1/2 inches from the floor.
- Places the buggy at the optimal angle to wash and drain.
- Dimensions: 29 inches W x 54 inches H.
- Shipping weight: 50 pounds.



This stainless steel one-man buggy washer makes buggy washing as easy as 1 - 2 - 3!



1 Place buggy in washer using lifting lugs.



2 Tilt washer and buggy back.



3 Clean and rinse inside and outside.

ITEM NO.	PRODUCT
2990 0450	Buggy Wash
EACH	
\$1,619.70	





Heavy-Duty Stainless Steel Receiving Desk

A versatile stainless steel desk for the workplace.

- Desk is made with three 9-inch deep storage compartments.
- 18-gauge stainless steel work surface measures 24 inches wide x 23 inches deep.
- Desk includes wall mounting brackets. Mobile stainless frame and casters sold separately.
- Optional stainless frame is constructed of 1-inch tubing with four, 5-inch swivel casters, 2 with brakes.
- Frame adds mobility and includes stainless undershelf for storage.
- Shipping Weight: 40 pounds.



Desktop locks to allow for document storage. Includes two keys.



Space saver desk includes wall mounting brackets.



Add optional legs and casters to turn unit into a convenient all-around desk.

ITEM NO.	PRODUCT	DIMENSIONS	EACH
2990 2101	Wall Mount Desk	24" x 23" x 12"	\$848.45
2990 2102	Optional Mobile Frame with Caster Set.	23" x 25" x 35-1/2"	576.40

Stainless Steel Stool

- 14-inch square seat with rounded corners fabricated from heavy-duty T-304 Stainless steel.
- Fully welded angle stainless steel legs and foot support.
- Corrosion-resistant stool is capable of withstanding wet, harsh and demanding environments.
- Overall height: 30 inches.



ITEM NO.	PRODUCT	EACH
2990 0195	Stainless Steel Stool	\$764.40



Aluminum Knockdown Tables

- Knockdown aluminum tables will not rust.
- All tables have an I-under brace for additional support.
- Optional undershelf nests on the frame below the table for convenient storage.
- Optional overshelf allows you to place objects up and out of the way.

BUILD YOUR OWN ALUMINUM KNOCKDOWN TABLE

Choose from three sizes of either a poly or a stainless steel top, and then add your options.

1. Choose your TYPE of table:

- Aluminum Table with Stainless Steel Top.
- Aluminum Table with Stainless Steel Top and Backsplash.
- Aluminum Table with Poly Top.
- Aluminum Table with Poly Top and Backsplash.

2. Choose the LENGTH of table:

- 48 inches.
- 72 inches.
- 96 inches.

3. Choose one or both OPTIONS:

- Stainless Steel Undershelf.
- Stainless Steel Overshelf.

NOW, look below at the ordering information box and determine which Product Numbers match the table you have built.

Knockdown Table with Poly Top

Poly tops come in multiple pieces for ease of handling.

ITEM NO.	SIZE	POLY TOP PIECES	F.O.B. FACTORY
			EACH
2510 3450	48" x 30" x 34" (This item can ship UPS) ..	2 ..	\$610.65
2510 3474	72" x 30" x 34" ..	3 ..	832.15
2510 3498	96" x 30" x 34" ..	4 ..	1,041.65

Knockdown Table w/Poly Top and Backsplash

ITEM NO.	SIZE	POLY TOP PIECES	F.O.B. FACTORY
			EACH
2510 3488	48" x 30" x 34" (This item can ship UPS) ..	2 ..	\$748.75
2510 3475	72" x 30" x 34" ..	3 ..	1,043.65
2510 3499	96" x 30" x 34" ..	4 ..	1,380.15

Optional Features

Stainless Steel Undershelf

ITEM NO.	SIZE	F.O.B. FACTORY
		EACH
2510 1848	48" x 18" x 2" (This item can ship UPS) ..	\$250.45
2510 1872	72" x 18" x 2" ..	355.45
2510 1896	96" x 18" x 2" ..	386.95

Optional Features

Stainless Steel Overshelf

ITEM NO.	SIZE	F.O.B. FACTORY
		EACH
2510 1248	48" x 12" x 1-1/2" (This item can ship UPS) ..	\$303.05
2510 1272	72" x 12" x 1-1/2" ..	460.95
2510 1296	96" x 12" x 1-1/2" ..	600.85



Optional overshelf.



Knockdown Table with Stainless Top

ITEM NO.	SIZE	F.O.B. FACTORY
		EACH
2510 3449	48" x 30" x 34" (This item can ship UPS) ..	\$769.85
2510 3473	72" x 30" x 34" ..	874.85
2510 3497	96" x 30" x 34" ..	1,199.65

Table w/Stainless Top and Backsplash

ITEM NO.	SIZE	F.O.B. FACTORY
		EACH
2510 3448	48" x 30" x 34" (This item can ship UPS) ..	\$784.95
2510 3472	72" x 30" x 34" ..	1,190.35
2510 3496	96" x 30" x 34" ..	1,605.35



Stainless Steel Work Tables

Rock Solid — No Wobble — Guaranteed

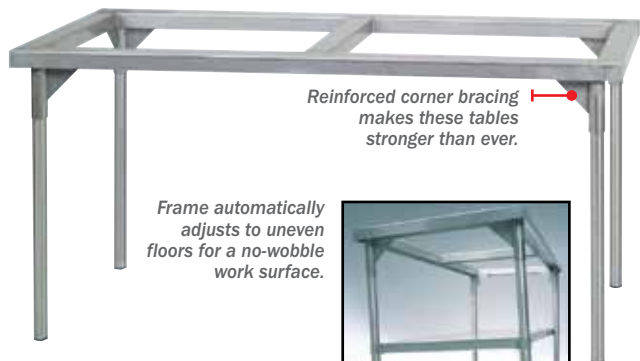

Reinforced corner bracing makes these tables stronger than ever.

Frame automatically adjusts to uneven floors for a no-wobble work surface.



Breaks down for easy shipping.



ASSEMBLES IN MINUTES!
The only tool you'll need is an Allen wrench and it's included.



Clips simplify removal of poly top.



Easily install lower shelf.

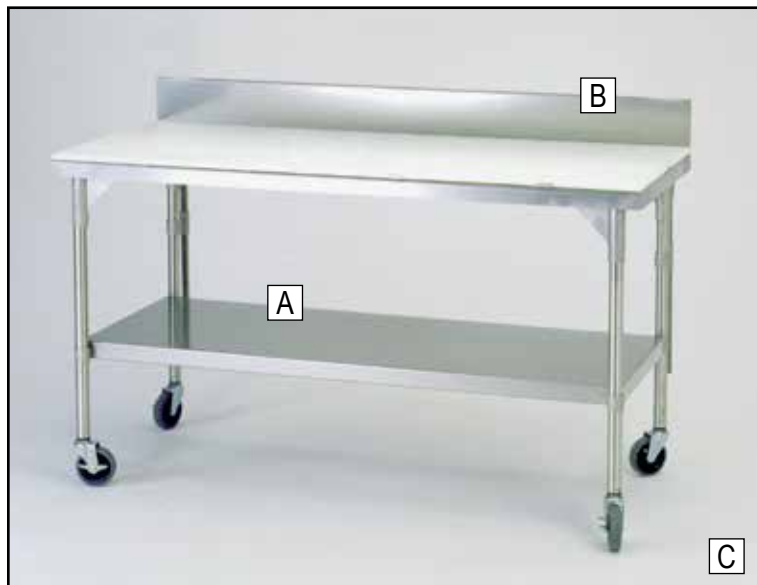

Full Stainless Top on Full Table

ITEM NO.	SIZE	SHIPPING WT.	F.O.B. FACTORY EACH
2990 2990	72" X 30"	102 lb.	\$2,300.15
2990 2991	96" x 30"	113 lb.	2,875.25

Split Poly Top on Full Table

ITEM NO.	SIZE	SHIPPING WT.	F.O.B. FACTORY EACH
2990 2992	72" X 30"	98 lb.	\$2,105.80
2990 2993	96" x 30"	131 lb.	2,544.00

Replacement Clips (for Poly Tables)

ITEM NO.	SIZE	EACH
2990 3254	For 72" Tables	\$13.50

BUILD YOUR OWN STAINLESS STEEL WORK TABLE

1. Start with a "Rock Solid" stainless frame:

- Unique design yields a table which is remarkably rigid front-to-back and side-to-side, yet flexible along its length to twist to accommodate uneven floors. Even with a one inch block under one leg, all legs make solid contact with the floor and the table won't wobble or shake, (see inset). The key is the oversized, welded gussets. Legs are adjustable to level the table.
- Available in 72 or 96 inch lengths x 30 inches deep.

2. Choose from a split-poly or full stainless steel work top

- No tools needed to install either top. Stainless steel clips hold poly top in place. Or, remove the clips and install the full stainless top in minutes. To comply with USDA regulations, the poly top is only available as a two-piece unit.
- 96 inches L x 30 inches D x 34 inches H.

3. Customize to suit your specific needs:

- Stainless Steel Shelf Kit. • Stainless Steel Backsplash. • Caster Kit.

A. Lower Stainless Shelf Kits

Fully adjustable stainless steel shelf. Shelf removes easily from clips for washdown, no tools needed.

ITEM NO.	SIZE	SHIPPING WT.	F.O.B. FACTORY EACH
2990 3250	For 72" Tables	40 lb.	\$761.20
2990 3251	For 96" Tables	55 lb.	922.80

B. Backsplash (for Poly Tables)

Backsplash is available for use with poly top tables.

ITEM NO.	SIZE	SHIPPING WT.	F.O.B. FACTORY EACH
2990 3248	For 72" Tables	13 lb.	\$355.90
2990 3249	For 96" Tables	15 lb.	387.40

C. Caster Kits

Add mobility with 5 inch diameter casters. Wheels lock at all four corners for stability while working.

ITEM NO.	SIZE	EACH
2990 3255	For 72" Tables (4 Locking Casters)	\$174.35
2990 3256	For 96" Tables (4 Lock, 2 Std.)	233.05

Stainless Steel Knockdown Table

- Available in three lengths with or without a 6-inch stainless steel backsplash and undershelf.
- 16-gauge, Type 304 stainless steel work surface, legs and rails.
- 12-gauge galvanized steel table channels provide maximum stability.
- Ships knocked-down with easy assembly — assembly hardware is included.



Optional 6-inch backsplash available.

Table ships knocked-down.

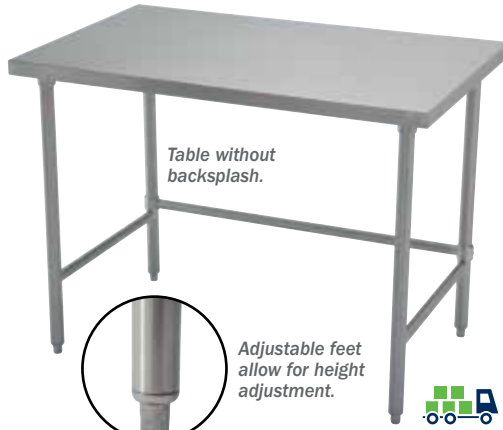
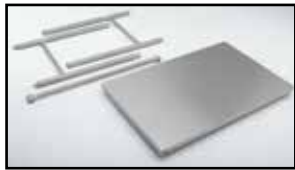

Table without backsplash.



Adjustable feet allow for height adjustment.



F.O.B. FACTORY



ITEM NO.	PRODUCT	DIMENSIONS	EACH
3048 2324	36" Table w/o Backsplash	36" x 24" x 36"	\$840.68
3048 2325	48" Table w/o Backsplash	48" x 24" x 36"	875.22
3048 2326	60" Table w/o Backsplash	60" x 24" x 36"	954.34
3048 1324	36" Table w/Backsplash	36" x 24" x 36"	840.68
3048 1325	48" Table w/Backsplash	48" x 24" x 36"	886.46
3048 1326	60" Table w/Backsplash	60" x 24" x 36"	965.58

Stainless Steel Mini Stuffing Table

- Working surface is crafted from heavy 14-gauge T-304 seamless stainless steel. Rustproof, corrosion resistant and is easy to clean.
- Legs are constructed with 16-gauge polished round stainless steel 1-5/8 inch diameter and with sturdy rigid-truss cross supports.
- Feet and legs allow up to 5 inches of over all height adjustment.
- Ships knocked-down with easy assembly.
- Work surface measures 33 inches deep x 57 inches long and features a slope to a 2-inch sink-type drain and has 1-1/2-inch formed top retaining edges.
- Table is extremely versatile and may be ordered with the Operator Notch section located on either side of the table.



Slope with 2-inch sink-type drain.



ITEM NO.	DIMENSIONS	EACH
2990 1030	33-1/10" x 57-1/10" x 28" to 33"	\$2,012.70

Stainless Steel Stand Alone Table

- Designed for food preparation facilities, kitchens and restaurants.
- Heavy-duty 14-gauge T-304 stainless steel with all welded construction makes them ideal as stand-alone equipment stand or to be placed where additional work space is needed.
- Features a full size middle storage shelf and all welded construction.
- This unit is suitable for wet or harsh environments and is easy to clean.
- Equipped with adjustable bullet style feet for easy leveling.
- Dimensions: 24 inches L x 20 inches W x 30 inches H.



Compact sized table can be used for small kitchen equipment.



NOTE: Arrives FULLY ASSEMBLED!

ITEM NO.	PRODUCT	EACH
2990 1127	SS Stand Alone Table	\$660.50

24-Inch x 30-Inch Aluminum Knock Down Table with Poly Top

- Made with heavy-duty aluminum frame.
- Includes four non-locking 4-inch casters.
- Available with or without 6-inch backsplash.

NOTE: 50 pound capacity tote INCLUDED!

► SEE PAGES 188 For Additional Tote Colors



Optional backsplash.



Tote slides easily on built-in slide rails.

► SEE PAGES 241 For Locking Casters



ITEM NO.	PRODUCT	DIMENSIONS	F.O.B. FACTORY EACH
2510 3501	Poly Top Table w/Tote	30" x 24" x 34"	\$573.65
2510 3502	Poly Top Table w/Tote and 6" Backsplash		759.95

HOW TO CALCULATE REPLACEMENT CUTTING BOARDS

1. Measure length and width in inches.
2. Multiply length x width for total square inches.
3. Divide total square inches by 144.
4. Round calculation up to the nearest foot.
5. Take that number x price per square foot.

$L \times W = \text{Total Square Inches}$

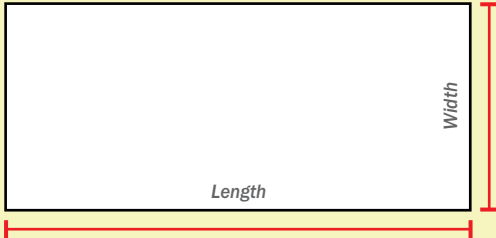

Example:

1. Board desired is 13 inches W x 76 inches L.
2. 13 inches x 76 inches = 988 square feet.
3. 988 divided by 144 = 6.86
4. Round 6.86 up to nearest foot = 7
5. Take 7 x price of board per square foot = Total price

We recommend boards no larger than 18 inches W x 5 feet L, removable for cleaning by a single worker.

Sanatec® Poly Cutting Board Table Tops

An economical alternative to wood surfaces.

- Made of sanitary polyethylene with a reversible slip-resistant pebble finish that won't dull knives.
- Surface will not absorb odors – clean with soap and water.
- Select from four thicknesses, sold per square foot.



CUSTOM CUT to Any Size or Shape to Fit Your Table!

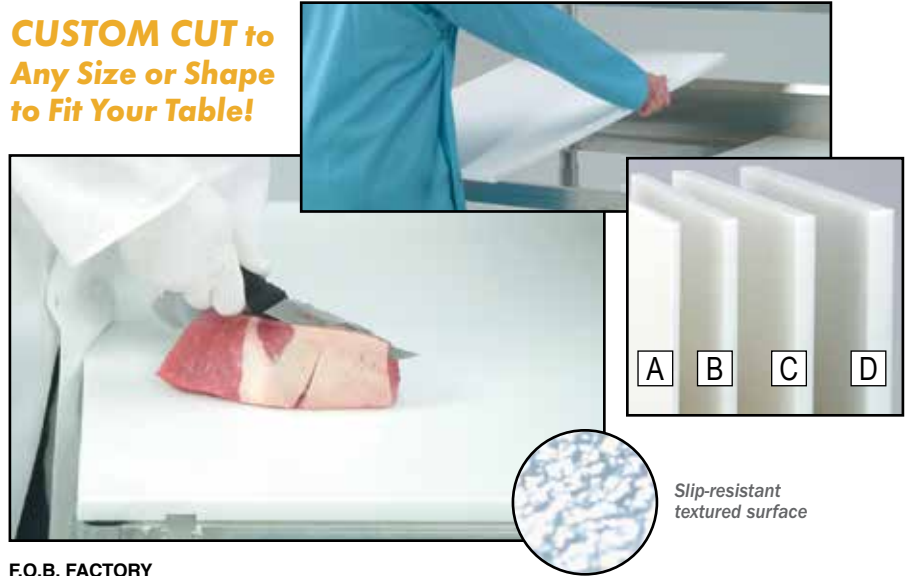

F.O.B. FACTORY

ITEM NO.	PRODUCT	SQ. FT.
3201 1424	A. 1/4" Cutting Board.....	\$17.62
3201 2094	B. 1/2" Cutting Board.....	30.05
3201 1425	C. 3/4" Cutting Board.....	33.61
3201 1426	D. 1" Cutting Board.....	40.62

Call for information on calculating dimensions for replacement cutting boards. Boards 3' x 4' or smaller ship UPS. Larger boards are shipped via freight.

Pre-Cut Sanatec® for Aluminum Tables

- Specify length of aluminum frame table.
4-foot table requires 2 pieces;
6-foot table requires 3 pieces;
8-foot table requires 4 pieces.
- Removable for easy cleaning.



ITEM NO.	DIMENSIONS	WEIGHT	EACH
3201 2500	30" x 24" x 3/4"	10 lb.	\$169.42

Colored Cutting Board Table Tops

- 1/2 inch thickness. • Sold per square foot.

ITEM NO.	COLOR	SQ. FT.
3538 01371	Blue, 1/2" Thick.....	\$33.06
3538 01381	Yellow, 1/2" Thick.....	33.06
3538 01391	Red, 1/2" Thick.....	33.06
3538 01401	Green, 1/2" Thick.....	33.06



Cutting Board Scraper/Refinisher



- Removes bacteria-harboring scratches and cuts.
- Dishwasher safe and easy to clean.



▶ 12 PER CASE.

ITEM NO.	PRODUCT	EACH
6387 17891	Scraper/Refinisher.....	\$49.30
6387 17991	Replacement Blade (2/Pack).....	42.01

Molded Plastic Wheels

Non-marking, white polyolefin wheels. Recommended for all applications where strict sanitation is required. Ideal for food plants and wet environments.

- Steam clean, detergent proof. • Acid-resistant.
- Will not mark floors. • Never requires lubrication.
- Very durable, quiet rolling. • Fits most popular caster frames.
- Withstand temperatures from -30 °F to 250 °F.



Standard White Polyolefin Wheels using a 1/2-Inch Spanner

ITEM NO.	A. WHEEL DIAMETER	B. TREAD WIDTH	C. BORE	D. HUB	LOAD CAPACITY	EACH
0844 2213	3"	1-3/8"	1/2"	1-1/2"	240 lb.	\$6.41
0844 4521	4"	1-3/8"	1/2"	1-1/2"	265 lb.	7.21
0844 2221	5"	1-1/4"	1/2"	1-1/2"	265 lb.	8.71
0844 2691	5"	1-1/2"	1/2"	1-5/8"	500 lb.	11.46
0844 2692	6"	1-1/2"	1/2"	1-5/8"	600 lb.	12.68
0844 2227	1/2" Stainless Steel Spanner Bushing For 3/8" Axle					9.20

WHEEL DIMENSIONS

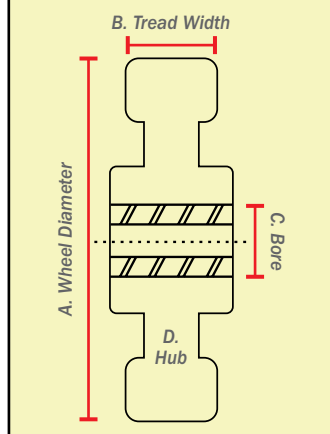

Standard White Polyolefin Wheels using a 3/4-Inch Spanner

ITEM NO.	A. WHEEL DIAMETER	B. TREAD WIDTH	C. BORE	D. HUB	LOAD CAPACITY	EACH
0844 2223	5"	2"	3/4"	2-3/16"	650 lb.	\$14.12
0844 2225	6"	2"	3/4"	2-3/16"	700 lb.	14.92
0844 2226	8"	2"	3/4"	2-3/16"	900 lb.	16.03
0844 2229	3/4" Stainless Steel Spanner Bushing For 1/2" Axle					15.48

Stainless Steel Spanner Bushings

- A. 1/2 inch OD x 3/8 inch ID.
B. 3/4 inch OD x 1/2 inch ID.



Easy to replace spanner bushings.

ITEM NO.	PRODUCT	EACH
0844 2227	A. 1/2" x 3/8"	\$9.20
0844 2229	B. 3/4" x 1/2"	15.48

Greaseable Zerk Axle and Delrin Spanner Bushing

- 3/4 inch OD x 1/2 inch ID x 2-5/16 inches L.
- Stainless axle is 3 inches long.



Greaseable/replaceable Zerk axle.



ITEM NO.	PRODUCT	EACH
0844 21331	Greaseable Axle w/Bushing	\$14.58

NOTE: Recommended when you replace wheels in order to extend wheel life in harsh environments.

Posi-Lock Brakes

Easy to install on your existing wheels and casters.

- Posi-Lock brakes fit all 1-3/8 inch to 1-1/2 inch tread width wheels using a 3/8 inch axle.

ITEM NO.	PRODUCT	EACH
0844 0003	For 3" Wheel	\$9.65
0844 0004	For 4" Wheel	11.41
0844 0005	For 5" Wheel	12.22
0844 0006	For 6" Wheel	11.55



NOTE: Not to be used with the Economy Plated Casters shown on facing page.



Economy Plated Casters

Zinc plated steel frames.

- Heavy-duty king pins.
- All swivels have double bearing raceways.
- Type I wheels for medium-duty applications.
- Type II wheels for heaviest loads and constant swiveling.
- Delrin bushing.

Type I shown without greaseable axle.



NOTE: See diagram to choose caster top plate needed.

STAINLESS STEEL TYPE II CASTER

Dual ball bearing raceways are stainless to withstand harsh environments.

Formed stainless caster forks are welded to lower raceway for maximum service.

Replaceable zerk fitting makes routine maintenance easy.

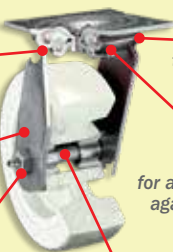

Upper and lower raceways are sealed with neoprene rubber to keep lubricant in and contaminants out.

Large king pin for added strength. Protects against impact and abuse.

Stainless spanners do not require lubrication.

Stainless Steel Casters

Resists rust and corrosion.

- Casters with poly wheels designed specifically to withstand constant use in harsh, corrosive wet environments.
- Whatever your application, we have the caster and wheel to fit it – in stock and ready to ship!
- Call today to discuss your specific corrosive applications.

NOTE: See diagram to choose caster top plate needed.



Zerk fitting makes routine maintenance easy.

Type I For Medium-Duty Applications, without Greaseable Axle

Rigid-Type I Top Plate

ITEM NO.	A. WHEEL DIAMETER	B. TREAD WIDTH	HEIGHT	LOAD CAPACITY	EACH
0844 2380	3"	1-3/8"	4-1/8"	240 lb.	\$11.95
0844 2382	4"	1-1/4"	5-1/8"	300 lb.	11.84
0844 2384	5"	1-1/4"	6-1/4"	300 lb.	17.03

Swivel-Type I Top Plate

ITEM NO.	A. WHEEL DIAMETER	B. TREAD WIDTH	HEIGHT	LOAD CAPACITY	EACH
0844 2379	3"	1-3/8"	4-1/8"	240 lb.	\$17.04
0844 2381	4"	1-1/4"	5-1/8"	300 lb.	16.28
0844 2383	5"	1-1/4"	6-1/4"	300 lb.	23.90

Type II For Heavy-Duty Applications, with Greaseable Axle

Rigid-Type II Top Plate

ITEM NO.	A. WHEEL DIAMETER	B. TREAD WIDTH	HEIGHT	LOAD CAPACITY	EACH
0844 2386	5"	2"	6-1/2"	650 lb.	\$20.35
0844 2388	6"	2"	7-1/2"	700 lb.	23.55
0844 2990	8"	2"	9-1/2"	900 lb.	27.52

Swivel-Type II Top Plate

ITEM NO.	A. WHEEL DIAMETER	B. TREAD WIDTH	HEIGHT	LOAD CAPACITY	EACH
0844 2385	5"	2"	6-1/2"	650 lb.	\$26.83
0844 2387	6"	2"	7-1/2"	700 lb.	30.36
0844 2991	8"	2"	9-1/2"	900 lb.	36.16

CASTER TOP PLATE ILLUSTRATIONS

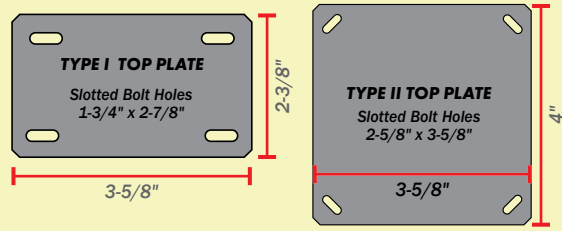

Type I For Medium-Duty Applications, Without Greaseable Axle

Rigid-Type I Top Plate

ITEM NO.	A. WHEEL DIAMETER	B. TREAD WIDTH	HEIGHT	LOAD CAPACITY	EACH
0844 2666	4"	1-3/8"	5-1/16"	300 lb.	\$37.43
0844 2670	5"	1-3/8"	6-1/8"	300 lb.	39.09

Swivel-Type I Top Plate

ITEM NO.	A. WHEEL DIAMETER	B. TREAD WIDTH	HEIGHT	LOAD CAPACITY	EACH
0844 2665	4"	1-3/8"	5-1/16"	300 lb.	\$75.18
0844 2669	5"	1-3/8"	6-1/8"	300 lb.	81.32

Type II For Heavy-Duty Applications, with Greaseable Axle

Rigid-Type II Top Plate

ITEM NO.	A. WHEEL DIAMETER	B. TREAD WIDTH	HEIGHT	LOAD CAPACITY	EACH
0844 2673	5"	1-1/2"	6-1/8"	300 lb.	\$52.48
0844 2677	6"	1-1/2"	7-3/16"	300 lb.	69.10
0844 3489	6"	2"	7-1/2"	700 lb.	64.74
0844 3491	8"	2"	9-1/2"	850 lb.	75.49

Swivel-Type II Top Plate

ITEM NO.	A. WHEEL DIAMETER	B. TREAD WIDTH	HEIGHT	LOAD CAPACITY	EACH
0844 2672	5"	1-1/2"	6-1/8"	300 lb.	\$80.45
0844 2676	6"	1-1/2"	7-3/16"	300 lb.	89.91
0844 3488	6"	2"	7-1/2"	700 lb.	93.40
0844 3490	8"	2"	9-1/2"	850 lb.	103.88

Heavy-Duty Plate Style Casters

- Swivel Casters — Formed legs are continuously welded, 1/4-inch steel top plate is cold forged and heat treated to relieve stress and add strength.
- Main Load Bearing — Fully hardened ball bearings in a hardened raceway.
- Thrust Bearing — Large diameter hardened ball bearings roll freely in a hardened raceway.
- Lube Fittings — Provided for both swivel and wheel bearings (for rubber wheels only).
- King Pin coined and stress relieved — Holds raceways precisely in alignment.
- Finish — Corrosion-resistant zinc. • 3/8-inch attached bolt.

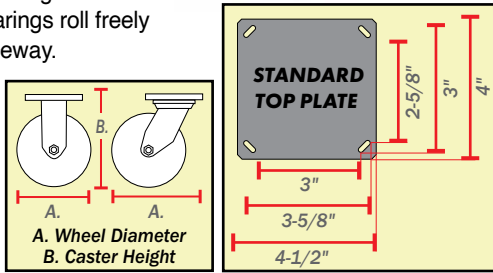

Mold-On Rubber Wheels

- For use in warehouse environments where floor protection and noise reduction are required.
- Soft rubber tread rolls over floor joints and small obstructions quietly and smoothly.
- Cushioned rubber tread permanently vulcanized to cast iron cores.
- Recommended for quiet movement with medium to heavy loads or where cushioning load is required.
- Zerk fitting in hub. • Temperature range: -30 °F to 160 °F.



ITEM NO.	WHEEL DIAMETER	TREAD WIDTH	HUB	AXLE DIAMETER	F.O.B. FACTORY CAPACITY	EACH
0844 0120	5"	2"	2-7/16"	3/4"	400 lb.	\$24.89
0844 0121	6"	2"	2-7/16"	3/4"	410 lb.	25.60
0844 0122	8"	2"	2-7/16"	3/4"	500 lb.	32.65
0844 0123	10"	2-1/2"	2-3/4"	1"	790 lb.	97.25
0844 0124	10"	3"	3"	1"	1,000 lb.	120.15
0844 0125	12"	2-1/2"	2-1/2"	1-1/4"	900 lb.	122.25
0844 0126	14"	3"	3"	1-1/4"	1,200 lb.	248.97

Reinforced Thermoplastic Wheels

- Suitable for food processing environments.
- High-resistance to shock and impact loads.
- Resists caustics and chemicals.
- Composed of reinforced thermoplastic.
- Temperature range: -20 °F to 250 °F.
- Low rolling resistance. • Will not absorb water.



ITEM NO.	WHEEL DIAMETER	TREAD WIDTH	HUB	AXLE DIAMETER	F.O.B. FACTORY CAPACITY	EACH
0844 0135	4"	1-1/2"	1-5/8"	1/2"	700 lb.	\$10.75
0844 0136	4"	2"	2-7/16"	1/2"	800 lb.	12.55
0844 0137	5"	2"	2-7/16"	1/2"	1,000 lb.	14.85
0844 0138	6"	2"	2-7/16"	1/2"	1,200 lb.	15.75
0844 0139	8"	2"	2-7/16"	1/2"	1,400 lb.	18.54

* Included reducer makes axle diameter 1/2".

Mold-On Rubber Wheels

ITEM NO.	PRODUCT	A. WHEEL DIA.	TREAD WIDTH	B. HEIGHT	CAPACITY	EACH
0844 0140	Swivel	5"	2"	400 lb.	400 lb.	\$33.00
0844 0141	Rigid	5"	2"	400 lb.	400 lb.	28.41
0844 0142	Swivel	6"	2"	410 lb.	410 lb.	37.00
0844 0143	Rigid	6"	2"	410 lb.	410 lb.	28.15
0844 0144	Swivel	8"	2"	500 lb.	500 lb.	36.94
0844 0145	Rigid	8"	2"	500 lb.	500 lb.	34.05

Polyurethane on Polyolefin Wheels

ITEM NO.	PRODUCT	A. WHEEL DIA.	TREAD WIDTH	B. HEIGHT	CAPACITY	EACH
0844 0154	Swivel	4"	2"	5-5/8"	700 lb.	\$27.35
0844 0155	Rigid	4"	2"	2"	5-5/8"	24.25
0844 0156	Swivel	5"	2"	6-1/2"	750 lb.	27.35
0844 0157	Rigid	5"	2"	6-1/2"	750 lb.	24.80
0844 0158	Swivel	6"	2"	7-1/2"	900 lb.	32.25
0844 0159	Rigid	6"	2"	7-1/2"	900 lb.	26.75
0844 0160	Swivel	8"	2"	9-1/2"	900 lb.	38.96
0844 0161	Rigid	8"	2"	9-1/2"	900 lb.	35.33

Reinforced Thermoplastic Wheels

ITEM NO.	PRODUCT	A. WHEEL DIA.	TREAD WIDTH	B. HEIGHT	CAPACITY	EACH
0844 0146	Swivel	4"	2"	5-5/8"	800 lb.	\$25.95
0844 0147	Rigid	4"	2"	5-5/8"	800 lb.	21.05
0844 0148	Swivel	5"	2"	6-1/2"	900 lb.	24.35
0844 0149	Rigid	5"	2"	6-1/2"	900 lb.	23.15
0844 0150	Swivel	6"	2"	7-1/2"	900 lb.	27.65
0844 0151	Rigid	6"	2"	7-1/2"	900 lb.	24.65
0844 0152	Swivel	8"	2"	9-1/2"	1,000 lb.	31.05
0844 0153	Rigid	8"	2"	9-1/2"	1,000 lb.	30.83

Polyurethane on Polyolefin Wheels

- Offers the same long wearing tread characteristics as polyurethane on steel or aluminum cores.
- Well suited for wet environments with delrin bearings.
- Resists chemicals, caustics, acids and oils.
- Composed of polyurethane tread mechanically and chemically bonded to a polyolefin core.
- Quiet rolling yet good load capacity.
- Temperature range: -40 °F to 180 °F.
- Not to be used where possibility for shock or high-impact exists.



ITEM NO.	WHEEL DIAMETER	TREAD WIDTH	HUB	AXLE DIAMETER	F.O.B. FACTORY CAPACITY	EACH
0844 0127	3"	1-1/4"	1-9/16"	3/8"	400 lb.	\$9.65
0844 0128	3-1/2"	1-1/4"	1-9/16"	3/8"	410 lb.	10.75
0844 0129	4"	1-1/4"	1-9/16"	3/8"	500 lb.	12.65
0844 0131	5"	1-1/4"	1-9/16"	3/8"	1,000 lb.	11.55
0844 0132	5"	2"	2-7/16"	1/2"	900 lb.	15.55
0844 0134	8"	2"	2-7/16"	1/2"	1,000 lb.	26.16

Polyurethane 6-Inch Wheels

Lasts 10 times longer than standard wheels.

- Non marking. • Quiet rolling with ball bearings.
- Temperature range: -50 °F to 180 °F.
- Requires minimum maintenance when installed with stainless bushings and zerk axle.



▶ SEE PAGE 238

For Bushings and Axles

ITEM NO.	WHEEL DIAMETER	TREAD WIDTH	HUB	CAPACITY	EACH
0844 16201	6"	2"	2-3/8"	1,000 lb.	\$47.04

Stem Type Casters

- Load Bearing — two full independent rows of hardened and polished ball bearings.
- Choose between Rubber Wheels or TPR (Thermo Plastic Rubber) Wheels for heavier load capacities.
- Stamped and formed construction. • Finish — corrosion-resistant zinc.

Threaded Stem

ITEM NO.	PRODUCT	STEM LENGTH	A. WHEEL DIAMETER	TREAD WIDTH	B. HEIGHT	CAPACITY	EACH
0844 0162	Rubber Wheel	1-1/8" ... 3"	15/16"	2-1/2"	110 lb.	\$10.06	
0844 0163	TPR Wheel	1-1/8" ... 3"	15/16"	2-1/2"	110 lb.	10.91	
0844 0164	TPR Wheel	1-1/2" ... 4"	15/16"	4-11/16"	115 lb.	12.54	
0844 0165	TPR Wheel	1-1/2" ... 5"	15/16"	5-23/32"	135 lb.	13.33	

Grip Ring Stem

ITEM NO.	PRODUCT	STEM LENGTH	A. WHEEL DIAMETER	TREAD WIDTH	B. HEIGHT	CAPACITY	EACH
0844 0166	TPR Wheel	1-3/8" ... 4"	15/16"	4-11/16"	115 lb.	\$12.25	
0844 0167	TPR Wheel	1-3/8" ... 5"	15/16"	5-23/32"	125 lb.	17.53	
0844 4201	TPR Wheel	2-1/32" ... 5"	15/16"	5-23/32"	135 lb.	16.65	
0844 4202	TPR Wheel	2-1/32" w/Brake	15/16"	5-23/32"	135 lb.	20.31	

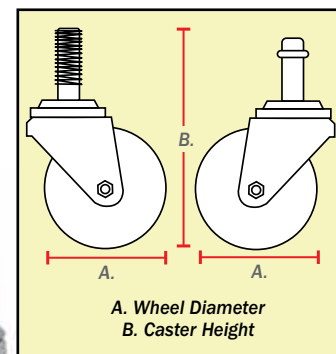

Grip Ring Stem



Threaded Stem

Replacement Dolly Casters

Grip Ring Style Casters

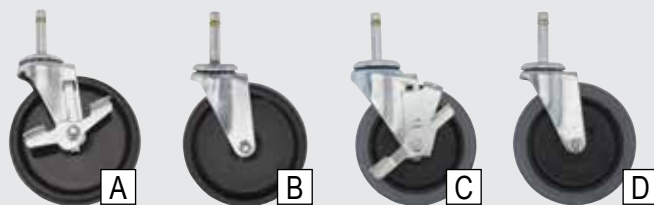
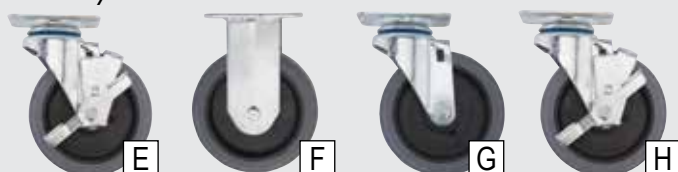

Plate Style Casters



Standard-Duty 5-Inch Casters

Caster capacity: 135 pounds per wheel

ITEM NO.	PRODUCT	EACH
0844 4202	A. Grip Ring Stem, Swivel, With Brake	\$20.31
0844 4201	B. Grip Ring Stem, Swivel, No Brake	16.65

NOTE: Freezer casters also available. Ask your CSR for details.

Heavy-Duty 5-Inch Casters

Caster capacity: 250 pounds per wheel

ITEM NO.	PRODUCT	EACH
0844 22201	C. Grip Ring Stem, Swivel, With Brake	\$23.79
0844 22191	D. Grip Ring Stem, Swivel, No Brake	19.65
0844 22171	E. Plate Swivel, With Brake	29.79
0844 22181	F. Plate Rigid, No Brake	18.12
0844 22161	G. Plate Swivel, No Brake (NOT for Freezer Usage)	23.23
0844 05181	Plate Swivel, No Brake (For Freezer Usage)	18.85
0844 22011	H. Plate Swivel, With Brake (For Freezer Usage)	32.37

For Compatible Dollies ▶ SEE PAGES 193-197

Sockets for Round and Square Tubing

Patented reinforced thermoplastic design.

- Sockets will not loosen or wear.
- Use with Grip-Ring style stems — fits 7/16 inch stems up to 1-1/2 inches long.

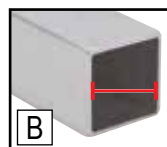
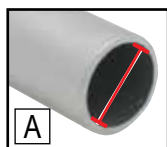

MADE IN USA

Sockets create snug fit for securing standard grip ring casters.

For use with 7/16-inch grip ring style stem casters.

A. Socket for Round Tubing

ITEM NO.	SOCKET	TUBE ID	EACH
0844 0168	RD1	0.777"	\$5.45
0844 0169	RD2	0.872"	
0844 0170	RD3	0.844"	
0844 0171	RD9	0.902"	
0844 0173	RD5	1.120"	
0844 0174	RD6	1.310"	
0844 0175	RD7	1.495"	

B. Socket for Square Tubing

ITEM NO.	SOCKET	TUBE ID	EACH
0844 0176	SQ1	0.620"	\$7.04
0844 0177	SQ2	0.652"	
0844 0178	SQ3	0.870"	
0844 0179	SQ4	.902"	
0844 0181	SQ6	1.120"	
0844 0182	SQ7	1.140"	
0844 0183	SQ8	1.152"	
0844 0185	SQ10	1.402"	

Polypropylene One-Piece Mixing Paddle Scrapers

- One-piece injection molded polypropylene cleans easily.
- Made from FDA compliant materials.
- Features a lightweight design with a modified T-grip handle.
- Paddle shape and tapered edges allow the scraper to mix product and scrape tubs and vats without damaging the work surface.
- Light-weight but virtually unbreakable.
- Temperature range: -22 °F to 176 °F.
- 40-Inch Paddle: Blade: 6 inches x 13 inches, Overall length: 40 inches, Weight: 2-3/10 pounds.
- 52-Inch Paddle: Blade: 6 inches x 13 inches, Overall length: 52 inches, Weight: 3 pounds.
- Some styles available in 8 colors.



40-Inch Paddles

With Holes

ITEM NO.	COLOR
5281 77421	Green
5281 77431	Blue
5281 77441	Red
5281 77451	White
5281 77461	Yellow

40-Inch Paddles

Without Holes

ITEM NO.	COLOR
5281 7752	Green
5281 77531	Blue
5281 77541	Red
5281 6775	White
5281 77561	Yellow

EACH
\$52.94

52-Inch Paddles

With Holes

ITEM NO.	COLOR
5281 77621	Green
5281 77631	Blue
5281 77641	Red
5281 7765	White
5281 77661	Yellow

52-Inch Paddles

Without Holes

ITEM NO.	COLOR
5281 77721	Green
5281 7773	Blue
5281 7774	Red
5281 77751	White
5281 77761	Yellow
5281 02651	Orange
5281 02931	Pink
5281 02661	Purple

EACH
\$64.61

Metal Detectable One-Piece Mixing Paddle Scrapers

- One-piece metal detectable mixing paddles are easy to clean and virtually unbreakable.
- Features a light-weight design with T-grip handle. • Available in 4 colors.
- Working temperature range: -22 °F/-30 °C to 183 °F/83 °C.
- 52-Inch Paddle: Blade: 6 inches x 13 inches, Overall length: 52 inches, Weight: 3-3/5 pounds.
- Tapered blade for scraping. • Made from FDA-compliant materials.

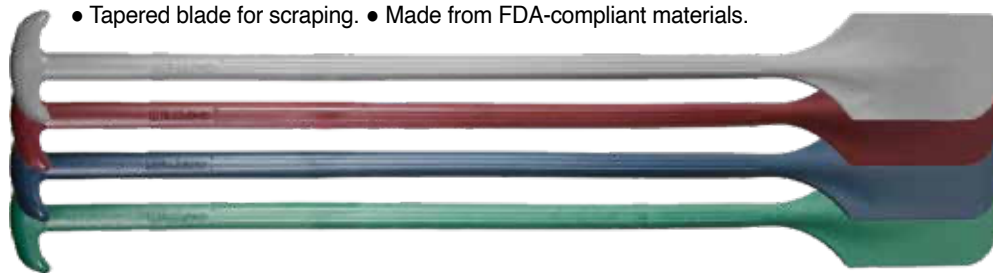

ITEM NO.	COLOR
5281 0220	Green
5281 0221	Blue
5281 0222	Red
5281 02231	Gray

▶ 6 PER CASE.

EACH
\$133.52

Stainless Steel Paddles

Perfect for stirring and mixing bulk products.

- Electropolished finish enhances corrosion resistance; finished surface for ease of cleaning.
- Tough and durable stainless steel mixing paddle has a one-piece, highly smooth finish.
- Seamless stainless steel type 304.

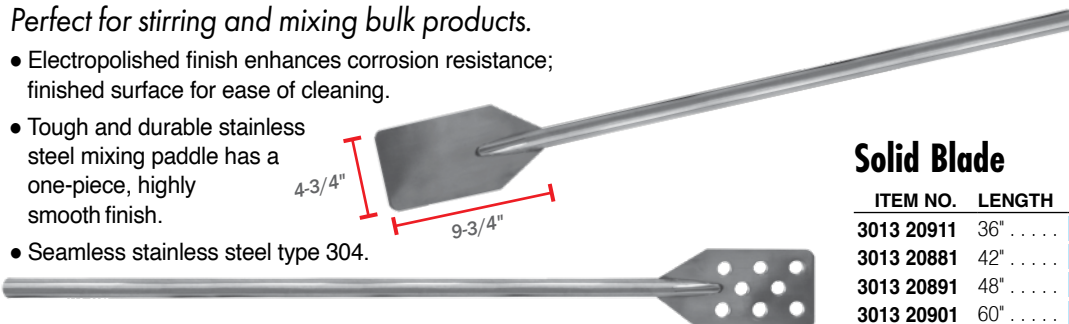

Solid Blade

ITEM NO.	LENGTH	EACH
3013 20911	36"	\$85.45
3013 20881	42"	102.75
3013 20891	48"	116.65
3013 20901	60"	129.35

Perforated Blade

ITEM NO.	LENGTH	EACH
3013 01731	36"	\$94.65
3013 01741	42"	113.15
3013 00711	48"	125.85
3013 01671	60"	142.05



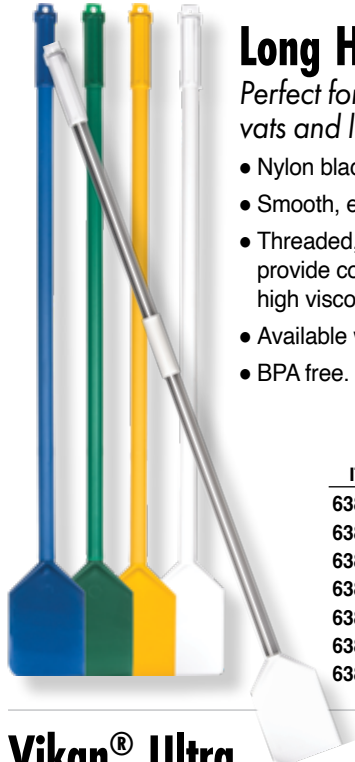

Long Handled Paddle Spatulas

Perfect for stirring, mixing and cleaning kettles, vats and large pots.

- Nylon blade sharpens and contours to your specific needs.
- Smooth, easy-to-clean, waterproof construction won't harbor bacteria.
- Threaded, heavy-duty stainless steel handles have plastic grips to provide comfort and heat resistance when used in high temperature or high viscosity applications.
- Available with stainless steel or nylon handles.
- BPA free. • Blade: 4-1/2 inches x 7-1/2 inches.



► 6 PER CASE.

ITEM NO.	PRODUCT	EACH
6387 00421	40" Nylon Handled Spatula, White	\$47.72
6387 16761	40" Nylon Handled Spatula, Yellow	47.72
6387 17861	40" Nylon Handled Spatula, Green	47.72
6387 17871	40" Nylon Handled Spatula, Blue	47.72
6387 54001	48" Stainless Steel Handled Spatula, White	135.40
6387 95001	72" Stainless Steel Handled Spatula, White (Not Shown)	156.82
6387 61121	4-1/2" x 7-1/2" Nylon Replacement Blade, White	23.68

Stainless Steel Dough Hoe

- Electropolished finish to enhance corrosion resistance, improve surface finish and ease of cleaning.
- Blade is smooth and easy to clean.
- T-Handle design.
- Blade: 7 inches x 10 inches.
- Overall length: 60 inches.



ITEM NO.	MFR. NO.
3013 20271	2077

EACH
\$287.65

Vikan® Ultra Hygiene Poly Handles, 51-Inches

- Made of food-grade polypropylene a safe alternative to fiberglass.
- Easy to clean rounded grip handles. • Euro thread.
- Hygienic smooth surface, sealed to prevent bacterial growth.
- Larger diameter ergonomic handle shape reduces worker fatigue.



Hygienic design with smooth surface, sealed to prevent bacterial growth.



GREEN	BLUE	RED	WHITE	YELLOW	ORANGE	BLACK	PURPLE	PINK	EACH
ITEM NO.	ITEM NO.	ITEM NO.	ITEM NO.	ITEM NO.	ITEM NO.	ITEM NO.	ITEM NO.	ITEM NO.	
5281 86021	5281 86031	5281 16041	5281 86051	5281 96061	5281 86071	5281 96091	5281 96081	5281 96011	\$30.70

Vikan Paddle Scraper

- Requires a hygienic European-thread handle.
- Choose from stiff or flexible.
- 4-3/10 inches W x 1 inch L x 8-3/4 inches H.



NOTE: Requires a Vikan® Euro-threaded handle, sold separately. SEE ABOVE.

Stiff

For substances requiring significant pressure.

ITEM NO.	COLOR
5281 03601	Green
5281 01131	Blue
5281 01141	Red
5281 00931	White
5281 01161	Yellow

Flexible

Functions as a spatula, making scraping container surfaces easy.

ITEM NO.	COLOR
5281 03611	Green
5281 01331	Blue
5281 01341	Red
5281 70131	White
5281 71361	Yellow

EACH
\$17.96

Food Hoe

Made from FDA compliant materials.

- Injection molded nylon construction.
- Ideal for cleaning cylindrical containers.
- Chemical and corrosion resistant.
- Maximum working temp: 300 °F.
- 8 inches x 11 inches.



Requires a Vikan® Euro-threaded handle, sold separately. SEE ABOVE.



ITEM NO.	COLOR
5281 90021	Green
5281 90031	Blue
5281 90041	Red
5281 9005	White
5281 90061	Yellow

EACH
\$30.68

Smooth bottom surface.

Standard Stainless Steel Shovels

- Durable stainless makes this shovel perfect for moving bulk materials.
- Electropolished finish enhances corrosion resistance.
- Welds are ground smooth for improved surface finish and ease of cleaning.
- No cracks or crevices that can trap debris or bacteria.
- Back of blade is smooth for easy cleaning.
- Certified NSF Standard 2 — food equipment.

SANI-LAV
COLUMBIA
PRODUCTS

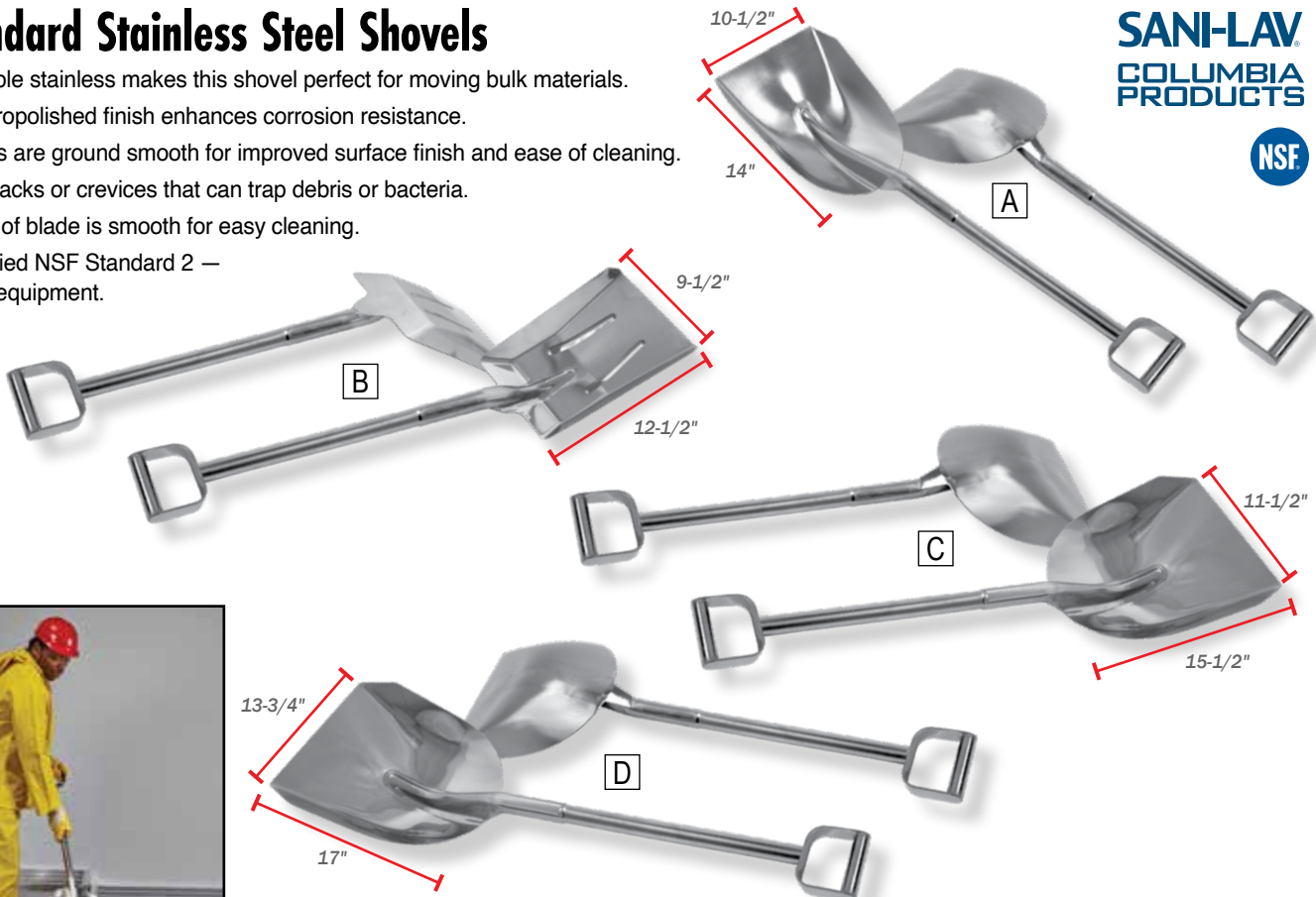

▶ 6 PER CASE.

ITEM NO.	BLADE DIMENSIONS	OVERALL LENGTH	WEIGHT	EACH
3013 02071	A. 10-1/2" x 14"	40"	5 lb.	\$239.15
3013 0217	B. 9-1/2" x 12-1/2"	40"	6 lb.	247.25
3013 0227	C. 11-1/2" x 15-1/2"	40"	8 lb.	254.15
3013 01591	D. 13-3/4" x 17"	44"	10 lb.	288.85

Standard Stainless Steel Spade



▶ 6 PER CASE.

ITEM NO.	BLADE DIMENSIONS	OVERALL LENGTH	WEIGHT	EACH
3013 02671	7" x 11"	39"	6 lb.	\$247.25

Standard Cast-Aluminum Shovel

Lightweight, durable one-piece construction stands up to rugged use.

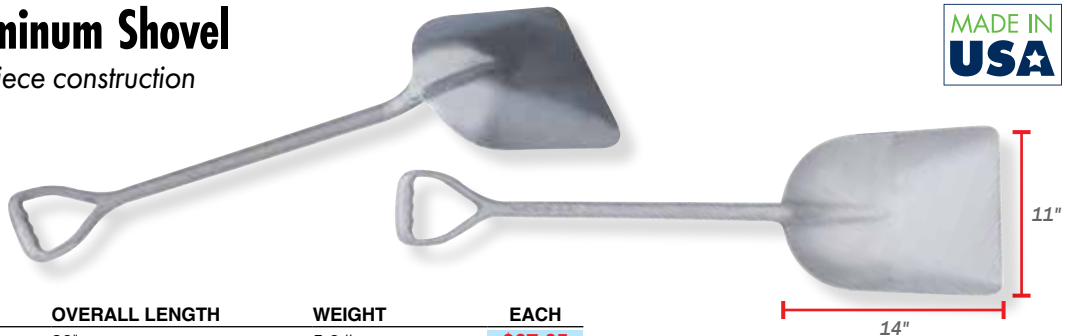

▶ 6 PER CASE.

ITEM NO.	BLADE DIMENSIONS	OVERALL LENGTH	WEIGHT	EACH
3086 1100	11" x 14"	38"	5.2 lb.	\$67.65



Reinforced Stainless Steel Shovels

- Reinforced stainless steel construction makes this shovel perfect for moving bulk materials.
- Electropolished finish enhances corrosion resistance.
- No cracks or crevices that can trap debris or bacteria.
- Certified NSF Standard 2-food equipment.

ITEM NO.	BLADE DIMENSIONS	OVERALL LENGTH	WEIGHT	EACH
3013 02081	A. 10-1/2" x 14"	40"	5 lb.	\$254.15
3013 12171	B. 9-1/2" x 12-1/2"	40"	6 lb.	254.15
3013 02281	C. 11-1/2" x 15-1/2"	40"	8 lb.	268.05
3013 01601	D. 13-3/4" x 17"	44"	10 lb.	300.45

▶ 6 PER CASE.

Reinforced Stainless Steel Spade

▶ 6 PER CASE.

ITEM NO.	BLADE DIMENSIONS	OVERALL LENGTH	WEIGHT	EACH
3013 02691	7" x 9"	39"	6 lb.	\$254.15

MADE IN USA

Square Steel Shovel with Fiberglass Handle

- Square point forged steel blade.
- Ergonomically shaped for comfort.
- 47-inch handle.

▶ 6 PER CASE.

ITEM NO.	BLADE DIMENSIONS	OVERALL LENGTH	WEIGHT	EACH
7146 00081	9-3/4" x 10-2/5"	57-2/5"	4.6 lb.	\$43.70

MADE IN USA

Plastic Shovels

- Sturdy injection molded one-piece polypropylene.
- Features a solid shaft and extra thick blade.
- Non-sparking.
- Made from FDA compliant materials.
- Chemical- and corrosion-resistant.
- Small Blade: 11 inches x 14 inches; Overall length: 38 inches; Weight: 2-7/10 pounds.
- Large Blade: 14 inches x 17 inches; Overall length: 42 inches; Weight: 4 pounds.



WHITE	YELLOW	ORANGE	RED	PINK	PURPLE	PRODUCT	EACH
ITEM NO.	ITEM NO.	ITEM NO.	ITEM NO.	ITEM NO.	ITEM NO.		
5281 98101	5281 69801	5281 01081	5281 00081	5281 00271	5281 01091	Small Blade..	\$42.35
5281 98251	5281 69891	5281 98271	5281 69831	5281 01591	5281 69921	Large Blade..	43.41

BLUE	LIME	GREEN	BROWN	GRAY	BLACK	PRODUCT	EACH
ITEM NO.	ITEM NO.	ITEM NO.	ITEM NO.	ITEM NO.	ITEM NO.		
5281 98131	5281 04791	5281 98121	5281 04781	5281 04801	5281 01481	Small Blade..	\$42.35
5281 69881	5281 04951	5281 69901	5281 04941	5281 04961	5281 98291	Large Blade..	43.41

Metal Detectable One-Piece Shovels

- One-piece, injection molded.
- Made from FDA compliant materials.
- Working temperature range: -22 °F/-30 °C to 176 °F/80 °C
- Heavy-duty and resilient.
- Corrosion-resistant.
- D-grip handle.
- Small Blade: 11 inches x 14 inches; Overall length: 38 inches.
- Large Blade: 14 inches x 17 inches; Overall length: 42 inches.

Small Blade

ITEM NO.	COLOR	
5281 02001	Green	▶ 6 PER CASE. EACH \$133.51
5281 02011	Blue	
5281 02021	Red	
5281 02031	Gray	



Large Blade

ITEM NO.	COLOR	
5281 02101	Green	▶ 6 PER CASE. EACH \$172.72
5281 02111	Blue	
5281 02121	Red	
5281 02131	Gray	



Non Food Contact Shovel

- Sturdy injection molded one-piece polypropylene.
- Features a solid shaft and extra thick blade.
- Constructed of regrind and recycled materials.
- Not for food contact.



ITEM NO.	SIZE	EACH
5281 0006	11" x 14"	\$37.05
5281 11051	14" x 17"	41.29

Ergonomic Color-Coded Shovels

Get the job done without doing a number on your back!

- Ergonomic design reduces strain when lifting from the floor level.
- Heavy-duty, one-piece, injection molded polypropylene construction.
- Working temperature range: -22 °F/-30 °C to 176 °F/80 °C.
- Blade: 14 inches x 18 inches.
- Overall length: 48 inches.
- Features a D-grip extended handle.
- Made from FDA compliant materials.
- Chemical and corrosion resistant.

ITEM NO.	COLOR
5281 98451	White
5281 98441	Red
5281 98421	Green
5281 98461	Yellow

▶ 6 PER CASE.
EACH
\$58.25



Ergonomic dual grip handles.



SANI-LAV
COLUMBIA
PRODUCTS

MADE IN
USA

NSF

Standard Stainless Steel Forks

- Electropolished finish to enhance corrosion resistance, improve surface finish and ease of cleaning.
- Overall lengths: (A) 60 inches, (B, C, D, E, F) 44 inches.

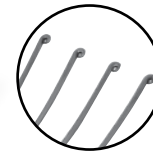
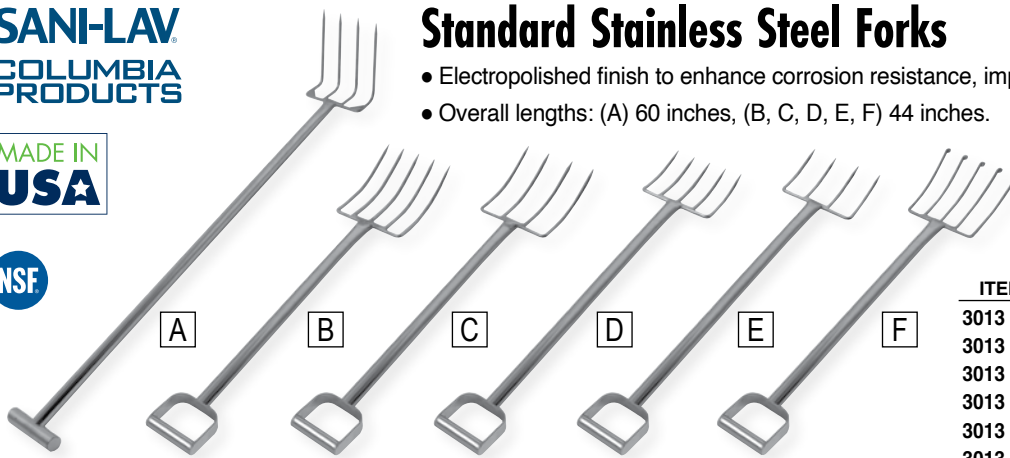

Cheese fork has curled end tines.

▶ 6 PER CASE.

ITEM NO.	PRODUCT	EACH
3013 2075	A. 4 Tine, 9" Drag Fork	\$280.75
3013 2071	B. 5 Tine, 12" Standard Fork	266.85
3013 2073	C. 4 Tine, 12" Standard Fork	266.85
3013 2072	D. 5 Tine, 8-1/2" Standard Fork	266.85
3013 2074	E. 4 Tine, 8-1/2" Standard Fork	266.85
3013 20851	F. 5 Tine, 10" Cheese Fork.	273.85

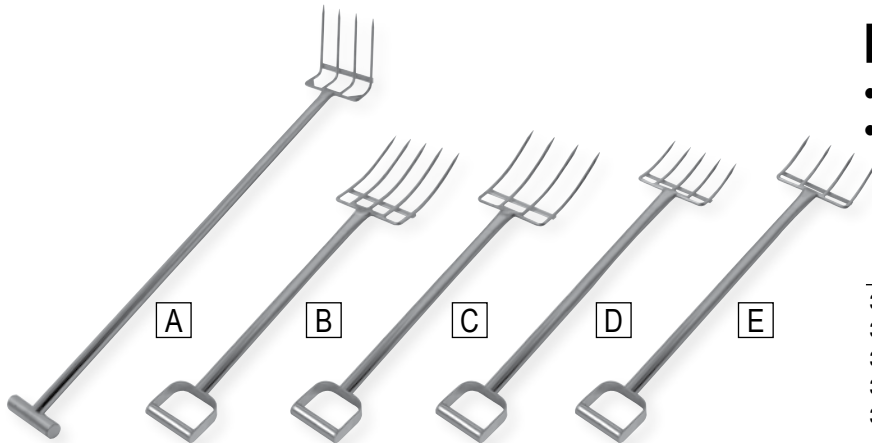

Reinforced Stainless Steel Forks

- Stainless steel plate welded across tines for added rigidity.
- Overall lengths: (A) 60 inches, (B, C, D, E) 44 inches.

▶ 6 PER CASE.

ITEM NO.	PRODUCT	EACH
3013 2077	A. 4 Tine, 9" Drag Fork	\$356.95
3013 2070	B. 5 Tine, 12" Standard Fork	322.35
3013 2079	C. 4 Tine, 12" Standard Fork	322.35
3013 2069	D. 5 Tine, 8-1/2" Standard Fork	322.35
3013 2080	E. 4 Tine, 8-1/2" Standard Fork	322.35

Super Reinforced Stainless Steel Forks

- Reinforced support brackets and heavy-duty welds for strength.
- Heavy-duty tines are 33% thicker.
- Overall lengths: (A) 60 inches, (B, C, D, E) 44 inches.

▶ 6 PER CASE.

ITEM NO.	PRODUCT	EACH
3013 20821	A. 4 Tine, 6-1/2" Drag Fork	\$366.25
3013 21711	B. 5 Tine, 12" Standard Fork	366.25
3013 21731	C. 4 Tine, 12" Standard Fork	366.25
3013 20831	D. 5 Tine, 8-1/2" Standard Fork	366.25
3013 20841	E. 4 Tine, 8-1/2" Standard Fork	366.25

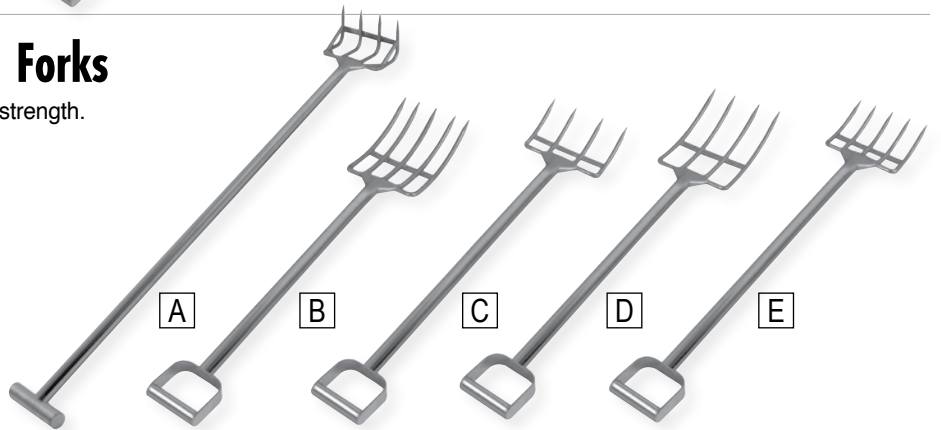

Vikan® Hygienic Fork and Rake

An innovative alternative to stainless steel made from FDA compliant materials.

- Fork Dimensions: 10-1/2 inches x 10-1/2 inches x 49 inches. • Rake Dimensions (without 51-inch handle): 8 inches x 8 inches.
- Light-weight injection molded polypropylene is chemical and corrosion-resistant.
- Working temperature of between -22 °F/-30 °C to 176 °F/80 °C.

▶ 10 PER CASE.

ITEM NO.	PRODUCT	EACH
5281 99051	A. Hygienic Plastic Fork	\$111.24
5281 99151	B. Hygienic Plastic Rake (Order Handle Separately)	45.52
5281 86051	C. 51" Vikan Ultra Hygiene Handle	30.70

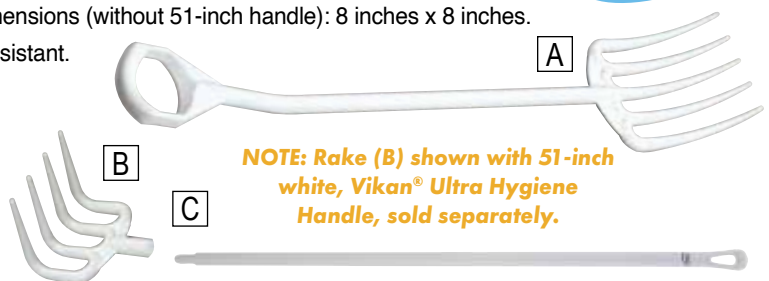

NOTE: Rake (B) shown with 51-inch white, Vikan® Ultra Hygiene Handle, sold separately.

Stainless Steel Hand Scrapers

- Polypropylene handle with stainless steel blade.
- Made of FDA compliant materials, safe for food contact.
- The beveled blade, perfect removing stubborn debris from smooth surfaces.
- Rigid blade and ergonomic handle stand up to repeated heavy use.



A. 1-1/2-Inch Blade

1-1/2 inches x 8-9/10 inches



B. 3-Inch Blade

3 inches x 8-9/10 inches



WHITE	YELLOW	ORANGE	RED	PINK	PURPLE	BLUE	LIME	GREEN	BROWN	GRAY	BLACK	▶ 12 PER CASE	
ITEM NO.	ITEM NO.	ITEM NO.	ITEM NO.	ITEM NO.	ITEM NO.	ITEM NO.	ITEM NO.	ITEM NO.	ITEM NO.	ITEM NO.	ITEM NO.	BLADE	EACH
5281 03071	5281 02761	5281 03051	5281 03081	5281 03111	5281 03041	5281 03091	5281 04201	5281 03101	5281 04211	5281 04111	5281 03031	A. 1-1/2"	\$9.84
5281 02981	5281 02971	5281 02961	5281 02991	5281 03021	5281 02951	5281 03001	5281 04051	5281 03011	5281 04091	5281 04001	5281 02941	B. 3"	10.95

Color-Coded Plastic Scrapers

- One-piece molded polypropylene with no seams or cracks to encourage bacterial growth.
- Supports programs that are aimed at preventing cross-contamination.
- Tapered handle and thumb indentation to ensure a strong grip.
- Narrow scraping blade allows access to tight spaces.
- Will not scratch metal surfaces.
- Chemical, rust and corrosion-resistant.
- Made from FDA compliant materials.



A. 3-Inch Blade

3 inches x 7-4/5 inches



B. 4-Inch Blade

4-1/4 inches x 9-1/5 inches



WHITE	YELLOW	ORANGE	RED	PINK	PURPLE	BLUE	LIME	GREEN	BROWN	GRAY	BLACK	▶ 12 PER CASE	
ITEM NO.	ITEM NO.	ITEM NO.	ITEM NO.	ITEM NO.	ITEM NO.	ITEM NO.	ITEM NO.	ITEM NO.	ITEM NO.	ITEM NO.	ITEM NO.	BLADE	EACH
5281 69351	5281 04911	5281 96171	5281 96141	5281 03881	5281 96181	5281 96131	5281 04861	5281 96121	5281 04921	5281 03821	5281 00161	A. 3"	\$6.31
5281 96251	5281 10041	5281 96271	5281 10031	5281 03981	5281 96281	5281 96231	5281 04901	5281 10011	5281 04891	5281 03901	5281 96291	B. 4"	7.37

Metal Detectable Hand Scoops and Scrapers

- No seams or cracks to encourage bacterial growth.

A. 82-Ounce Scoop

15 inches x 6 inches x 3-1/2 inches

B. 32-Ounce Scoop

11-1/2 inches x 4-1/2 inches x 3 inches

C. Large Scraper

4-2/5 inches x 9-7/10 inches

D. Small Scraper

3 inches x 8 inches



GREEN	BLUE	RED	GRAY	PRODUCT	SIZE	EACH
5281 02401	5281 02411	5281 02421	5281 02431	A. Hand Scoop	82 oz	\$35.98
5281 02351	5281 02361	5281 02371	5281 02381	B. Hand Scoop	32 oz	25.39
5281 02301	5281 02311	5281 02321	5281 02331	C. Hand Scraper	Large	13.74
5281 02251	5281 02261	5281 02271	5281 02281	D. Hand Scraper	Small	10.55

Vikan® Threaded Handle Scrapers

Threaded grip enables any Vikan color-coded handle to be screwed into the grips, which allows cleaning of difficult to reach areas.

- Slightly rounded blade corners prevent damage to the surface being cleaned and operator injury.
- Stainless steel scraper is suitable for removing stubborn debris.
- Nylon blade is suitable for loosening stubborn debris on smooth surfaces and sensitive equipment.
- Nylon blade can withstand hot surfaces when used at intervals of no more than 2 minutes at a time.



NOTE: Can be used with Vikan® European-thread handle, sold separately. SEE BELOW.

A. 2-Inch Stainless Steel Blade

2 inches x 8 inches



B. 4-Inch Stainless Steel Blade

4 inches x 8 inches



C. 4-Inch Nylon Blade

4 inches x 8 inches



WHITE	YELLOW	ORANGE	RED	PURPLE	BLUE	GREEN	BLACK	PRODUCT	EACH
H710 00231	H710 00221	H710 00191	H710 00241	H710 00181	H710 00211	H710 00201	H710 00171	A. 2" SS	\$18.65
H710 00131	H710 00261	H710 00271	H710 00391	---	H710 00141	H710 00151	---	B. 4" SS	23.05
5281 03661	5281 03671	---	5281 03641	---	5281 03631	5281 03621	---	B. 4" Nylon	14.79

▶ 12 PER CASE.

Vikan® Ultra Hygiene Poly Handles

- Made of food-grade polypropylene a safe alternative to fiberglass.
- Easy to clean rounded grip handles.
- Hygienic smooth surface, sealed to prevent bacterial growth.
- Larger diameter ergonomic handle shape reduces worker fatigue.



Hygienic design with smooth surface, sealed to prevent bacterial growth.

GREEN	BLUE	RED	WHITE	YELLOW	ORANGE	BLACK	PURPLE	PINK	BROWN	LIME	GRAY	PRODUCT	EACH
5281 86021	5281 86031	5281 16041	5281 86051	5281 96061	5281 86071	5281 96091	5281 96081	5281 96011	---	---	---	51"	\$30.70
5281 86221	5281 16231	5281 16241	5281 96301	5281 96321	5281 86271	5281 96311	5281 86281	5281 96211	H710 00991	5281 03351	5281 04291	59"	30.70

▶ 10 PER CASE.

Dough Cutter

- Stain-free, high-carbon steel with slip-resistant polypropylene handle.
- Withstands high and low temperatures.



▶ 6 PER BOX.

ITEM NO.	PRODUCT	EACH
5816 01961	6" x 3" Dough Cutter	\$15.97

Dough Cutter/Scraper

Textured white polypropylene handle provide slip-resistant grip.

- Dishwasher safe.
- Stain-free, high-carbon chrome molybdenum steel.



TRAMONTINA



ITEM NO.	PRODUCT	EACH
3450 92161	6" x 3" Dough Cutter/Scraper	\$14.95

Stainless Steel Industrial Scoops

Certified NSF/ANSI Standard 2 Food Equipment.

- Constructed from heavy-duty 18-gauge type 304 stainless steel.
- Fully welded, no spaces where any particles can gather.
- Completely seamless with large radiuses that ensure easy cleaning.
- Designed for heavy usage and hygienic applications.

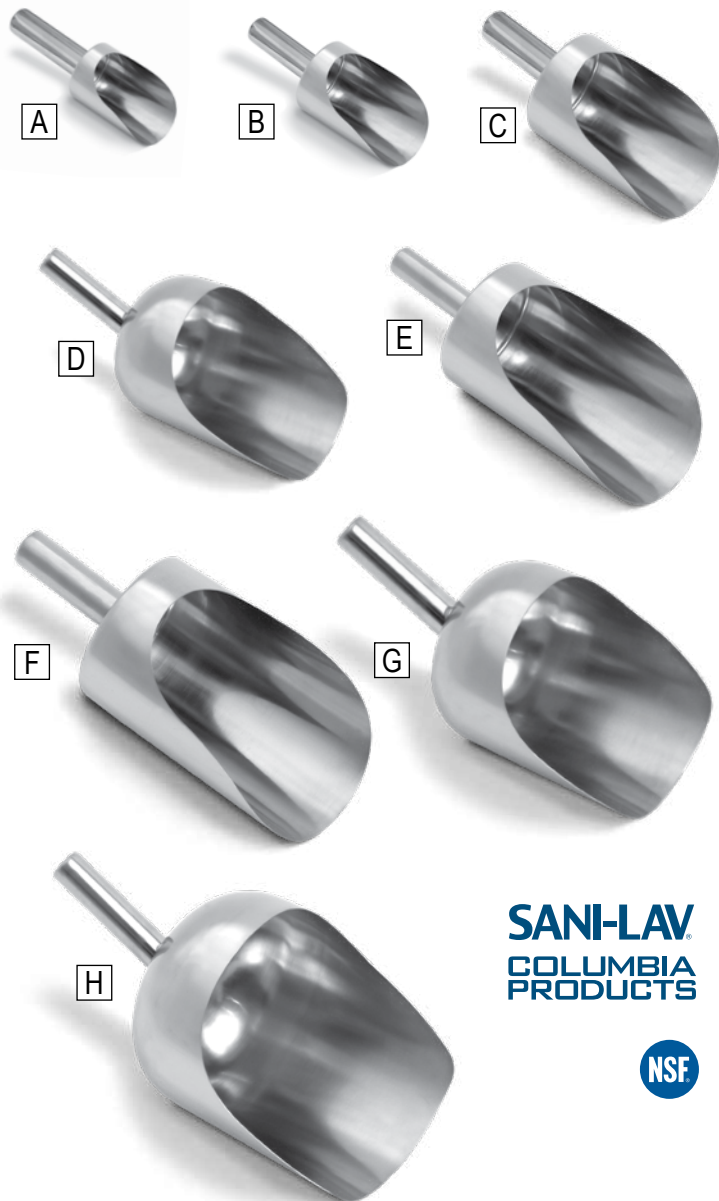

SANI-LAV
COLUMBIA
PRODUCTS



▶ 6 PER CASE.

ITEM NO.	PRODUCT	BOWL DIMENSIONS	EACH
3013 3997	A. 8 oz./1/2 Pint	2-3/4" x 4"	\$83.15
3013 4002	B. 16 oz./1 Pint	3-3/4" x 5"	87.75
3013 4003	C. 32 oz./1 qt.	4-1/2" x 6-5/8"	94.65
3013 01681	D. 52 oz./1-5/8 qt.	5-1/4" x 5-1/4"	109.65
3013 9004	E. 64 oz./2 qt.	5" x 8-1/4"	112.05
3013 4005	F. 96 oz./3 qt.	5-1/2" x 9-1/2"	123.65
3013 3998	G. 128 oz./1 Gallon	6-1/4" x 8-1/2"	127.05
3013 3999	H. 160 oz./5 qt.	8-1/2" x 10"	142.05

Stainless Steel Pharma Scoops

Certified NSF/ANSI Standard 2 Food Equipment.

- Ideal for use powders and granules or any hygienic application.
- Constructed from heavy-duty type 316, stainless steel that is highly resistant to corrosion.
- Fully welded to ensure that there are no spaces for particles to gather.
- Completely seamless, with large radiuses to insure easy cleaning.

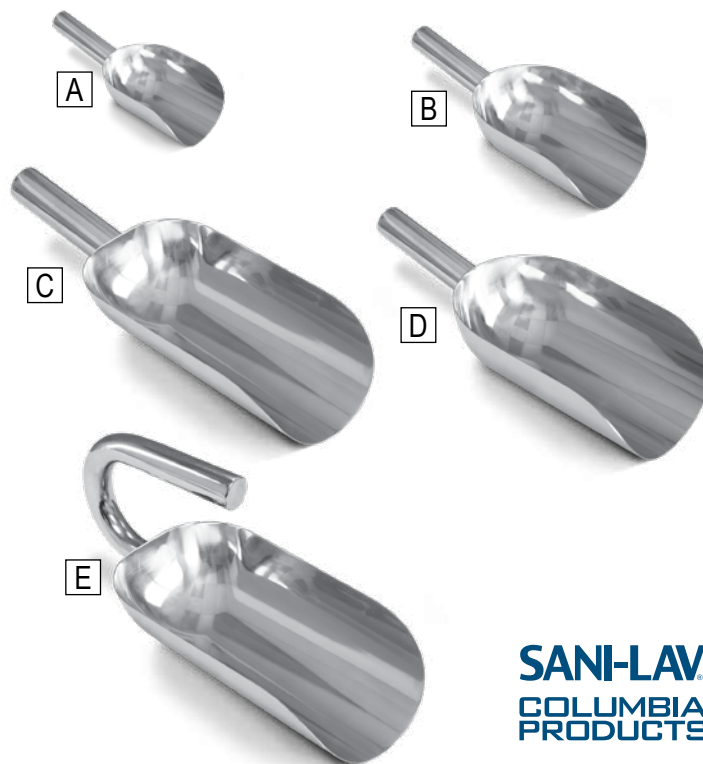

SANI-LAV
COLUMBIA
PRODUCTS

▶ 6 PER CASE.

ITEM NO.	PRODUCT	BOWL DIMENSIONS	HANDLE	EACH
3013 00431	A. 8 oz.	4" x 6"	Straight 5"	\$72.75
3013 00441	B. 16 oz.	5" x 7-3/4"	Straight 5"	94.65
3013 00401	C. 32 oz.	5" x 9"	Straight 5"	101.65
3013 00411	D. 50 oz.	5-1/2" x 9"	Straight 5"	127.05
3013 01691	E. 32 oz.	4-7/8" x 6"	Curved 6"	106.25

Aluminum Scoops

- High-quality, stain-resistant aluminum alloy.
- One-piece, smooth finish casting.



▶ 6 PER CASE.

ITEM NO.	PRODUCT	BOWL DIMENSIONS	EACH
3009 07041	22 oz.	4" x 7"	\$17.38
3009 07051	36 oz.	5" x 8-1/4"	23.01
3009 07061	56 oz.	5-1/2" x 10-1/4"	25.33

White Plastic Scoop

- Dimensions: 6 inches x 9 inches x 3-1/4 inches.
- Made of sanitary, seamless injection-molded white poly.
- Capacity: 80 ounces.



▶ 6 PER CASE.

ITEM NO.	PRODUCT	EACH
3049 25151	80-oz. Scoop	\$8.25

Bouncer® Scoops



- Clean, durable polycarbonate.
- NSF certified. • Easy to clean.
- Commercial dishwasher safe.
- Large grip with hole for hanging.
- Light-weight.



▶ 12 PER CASE.

ITEM NO.	PRODUCT	EACH
1770 78201	32-oz. Scoop	\$16.15

Dur-X™ Utility Scoop

- Designed for better weight distribution and improved handling.
- Heavy-duty, polyethylene with smooth easy-to-clean surface, dishwasher safe.



▶ 6 PER CASE.

ITEM NO.	PRODUCT	EACH
1770 78221	64-oz. Scoop	\$12.95

Colored Plastic Scoops



- Can be sterilized and stacked for storage.
- One-piece molded polypropylene.
- Capacity: Mini: 16 ounce; Small: 32 ounce; Large: 82 ounce.
- Chemical-resistant. • Made from FDA-compliant materials.



Mini, 16 Ounce Small, 32 Ounce Large, 82 Ounce

ITEM NO.	COLOR	ITEM NO.	COLOR	ITEM NO.	COLOR
5281 30051	White	5281 64001	White	5281 50051	White
5281 30061	Yellow	5281 40061	Yellow	5281 46331	Yellow
5281 30071	Orange	5281 40051	Orange	5281 50071	Orange
5281 30041	Red	5281 64021	Red	5281 46321	Red
5281 03451	Pink	5281 40011	Pink	5281 50011	Pink
5281 30081	Purple	5281 40081	Purple	5281 50081	Purple
5281 30031	Blue	5281 64031	Blue	5281 65011	Blue
5281 04821	Lime	5281 04851	Lime	5281 04511	Lime
5281 30021	Green	5281 64011	Green	5281 46301	Green
5281 04811	Brown	5281 04841	Brown	5281 04881	Brown
5281 04831	Gray	5281 04871	Gray	5281 04491	Gray

▶ 12 PER CASE.

EACH
\$5.26

▶ 12 PER CASE.

EACH
\$6.31

▶ 12 PER CASE.

EACH
\$7.36

Transparent Polycarbonate Scoops

- Rustproof, durable molded plastic.
- Retains look and performance, even after multiple washings.

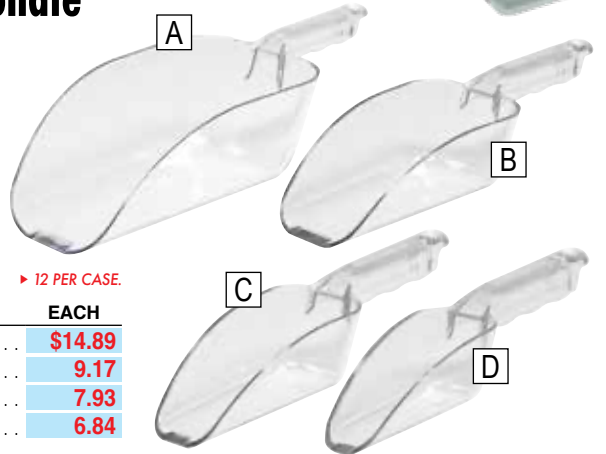

▶ 12 PER CASE.

ITEM NO.	PRODUCT	EACH
2432 96571	A. 64-oz. Scoop	\$14.89
2432 08741	B. 24-oz. Scoop	9.17
2432 68101	C. 12-oz. Scoop	7.93
2432 97111	D. 6-oz. Scoop	6.84

Colored Plastic Mega Scoops



- One-piece molded polypropylene, no seams to trap bacteria.
- Made from FDA-compliant materials. • Holds up to 128 ounces (1 gallon).
- Chemical-resistant. • Can be sterilized.



Measure lines embossed inside scoop.

Able to store upright or flat.

ITEM NO.	COLOR
5281 6551	Green
5281 6552	Blue
5281 6553	Red
5281 03281	Yellow
5281 6550	White

▶ 12 PER CASE.

EACH
\$13.73



Food Storage Containers

Lids allow for easily recorded food and date information.

- Temperature range from -20 °F to 212 °F. • NSF certified and commercial dishwasher safe.
- Positive locking lids have gripper ring. • Seamless white containers are easy-to-clean and stain-resistant.



▶ 12 PER CASE.

ITEM NO.	PRODUCT	DIMENSIONS	EACH
1770 20241	2 qt.	8-1/2" dia. x 4-1/4"	5.35
1770 76681	4 qt.	8-1/2" dia. x 7.1"	7.55
1770 57231	6 qt.	10" dia. x 7.9"	8.55
1770 57241	8 qt.	10" dia. x 10-3/5"	10.75
1770 04421	Lid for 2 and 4 qt. Containers, Yellow		5.35
1770 57251	Lid for 6 and 8 qt. Containers, Yellow		5.35



▶ 6 PER CASE.

ITEM NO.	PRODUCT	DIMENSIONS	EACH
1770 57261	12 qt.	3.1" dia. x 8"	\$16.15
1770 57281	22 qt.	13.1" dia. x 14"	23.75
1770 15181	22-qt w/Bail	13.1" dia. x 14"	29.05
1770 57301	Lid for 12 and 22 qt. Containers, Yellow		9.65

Squares™ Food Storage Containers

- Ideal for storing large quantities of spices, toppings, rice and baking ingredients.
- Accurately printed measurements keep track of remaining contents.
- NSF Listed; dishwasher safe.

White - Polyethylene

Withstands temperatures from 32°F to 160°F.

▶ 6 PER CASE.

ITEM NO.	PRODUCT	DIMENSIONS	EACH
6387 23821	6 qt., Red.	8-3/4" square x 7-3/10"	\$9.39
6387 23831	8 qt., Red.	8-3/4" square x 9"	10.46
6387 23441	22 qt., Blue	11-1/10" square x 15-7-10"	26.20

Clear - Polycarbonate

Withstands temperatures from -40°F to 212°F.

▶ 6 PER CASE.

ITEM NO.	PRODUCT	DIMENSIONS	EACH
6387 23841	2 qt., Green	7.13" square x 3-4/5"	\$6.24
6387 23851	6 qt., Red.	8-3/4" square x 7-3/10"	13.60
6387 23861	12 qt., Blue	11-1/10" square x 8-1/4"	20.95
6387 23871	6 qt., Blue	11-1/10" square x 12-3/5"	31.45



Squares™ Food Storage Container Lids

- Fitted lids fit both white and clear containers.
- Pull tab with hang hole makes container opening and storing quick and easy.
- Recessed interior stackable design saves space.
- NSF Listed; dishwasher safe.

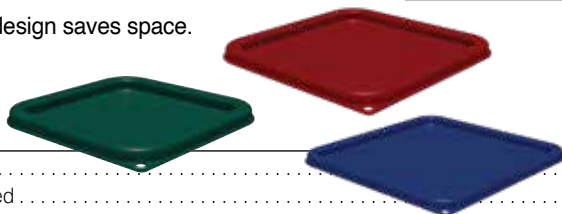

▶ 6 PER CASE.

ITEM NO.	PRODUCT	EACH
6387 23491	Lid for 2 qt., Green	\$4.14
6387 23511	Lid for 6 and 8 qt., Red	4.76
6387 10801	Lids for 12, 18 and 22 qt., Blue	5.19

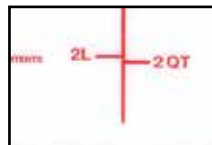

Label area to keep track of contents and use-by dates.



Wide, built-in handles provide a more secure grip and facilitate fast drying.



Stacking lugs save space by preventing jamming.



High-Heat Spatulas and Spoons

Dishwasher safe scrapers resist heat up to 500 °F/260 °C.

- Stain- and scratch-resistant design protects grill and cookware.
- Handle is always cool to the touch, even when used in the hottest of applications.
- Clean-Rest™ feature keeps blade off surface, reducing cross-contamination.

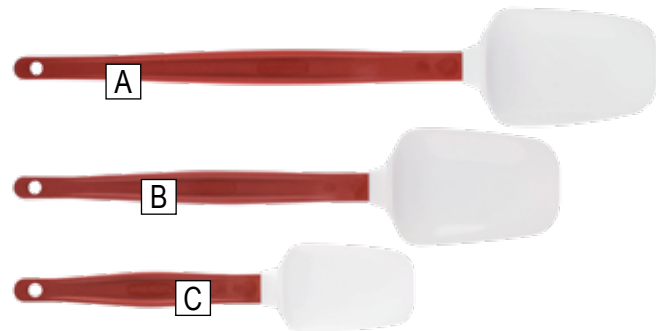

Notched spatula scraper blade cleanly scrapes sides of pans.



Molded-in hook allows for easy attachment to a pan.

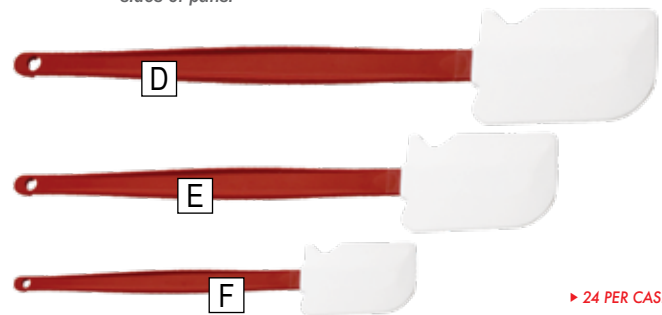

▶ 24 PER CASE.

ITEM NO.	PRODUCT	EACH
1770 19681	A. 16-1/2" Spoon	\$28.45
1770 19671	B. 13-1/2" Spoon	22.95
1770 19661	C. 9-1/2" Spoon	19.75
1770 19641	D. 16-1/2" Spatula	28.45
1770 06591	E. 13-1/2" Spatula	22.95
1770 06601	F. 9-1/2" Spatula	19.75

Measuring Cups

Crystal-clear material makes measuring easy.

- Molded handle will not break off.
- Dishwasher safe; not affected by food acids.
- Measurements cannot be scratched, chipped or washed off.
- Printed on one side in metric and on the other in standard measurements.



▶ 12 PER CASE.

ITEM NO.	PRODUCT	EACH
2432 02511	1 Cup	\$7.96
2432 02491	1 Pint (2 Cups)	11.37
2432 03101	1 Quart (4 Cups)	13.71
2432 02521	2 Quart (8 Cups)	17.12
2432 60031	4 Quart (1 Gallon)	18.29

Vikan® Colored Plastic Bowl Scoops



- One-piece molded polypropylene with no seams or cracks to encourage bacterial growth.
- Pour spout design with raised handle and thumb grip.
- Made from FDA compliant materials.
- Measured graduation marks.

Small, 32 Ounces

7-1/4 inches x 3-1/4 inches

ITEM NO.	COLOR
5281 01371	White
5281 01381	Yellow
5281 04401	Orange
5281 01361	Red
5281 04471	Pink
5281 01901	Purple
5281 01351	Blue
5281 01321	Green

▶ 12 PER CASE.

EACH
\$14.79

Large, 64 Ounces

7-1/4 inches x 4-3/4 inches

ITEM NO.	COLOR
5281 01301	White
5281 01311	Yellow
5281 01291	Red
5281 01281	Blue
5281 01271	Green

▶ 12 PER CASE.

EACH
\$15.85



Vikan® Flat Sided Pails

Optional stainless steel mounting bracket allows the pail to be stored upside down against a wall to allow the pail to drain and dry.



5-gallon pail has side handles and comfort grip on handle.



- Polypropylene pail is designed with one side flat so the pail can be stored flush against a wall.
- Raised bottom for added stability and a wide spout to prevent spilling and splashing while pouring.
- Handle constructed of non-rusting stainless steel.
- Optional snap-on lid to keep pail contents secure.
- Available in 1-1/2, 3 and 5 gallon sizes.
- 5-gallon pail has added side handles and comfort grip.



A. 1-1/2 Gallon

WHITE	YELLOW	ORANGE	RED	PINK	PURPLE	BLUE	LIME	GREEN	BROWN	GRAY	BLACK	▶ 12 PER CASE.	
ITEM NO.	ITEM NO.	ITEM NO.	ITEM NO.	ITEM NO.	ITEM NO.	ITEM NO.	ITEM NO.	ITEM NO.	ITEM NO.	ITEM NO.	ITEM NO.	PRODUCT	EACH
5281 02071	5281 02081	5281 02091	H710 00831	5281 02051	5281 00091	5281 02601	5281 03801	5281 01231	5281 03691	5281 03811	5281 01541	Pails	\$26.45
5281 02241	5281 02291	5281 02341	5281 03841	5281 02141	5281 03851	5281 03831	5281 03891	5281 02191	5281 03871	5281 03911	5281 03861	Lids	8.43

B. 3 Gallon

WHITE	YELLOW	ORANGE	RED	PINK	PURPLE	BLUE	LIME	GREEN	BROWN	GRAY	BLACK	▶ 5 PER CASE.	
ITEM NO.	ITEM NO.	ITEM NO.	ITEM NO.	ITEM NO.	ITEM NO.	ITEM NO.	ITEM NO.	ITEM NO.	ITEM NO.	ITEM NO.	ITEM NO.	PRODUCT	EACH
5281 68651	5281 68661	5281 68671	5281 68641	5281 03231	5281 68701	5281 68631	5281 03301	5281 68621	5281 03241	5281 03251	5281 68681	Pails	\$30.69
5281 68751	5281 68761	5281 68771	5281 68741	5281 03711	5281 68801	5281 68731	5281 03681	5281 68721	5281 03701	5281 03651	5281 6879	Lids	15.84

C. 5 Gallon

WHITE	YELLOW	RED	BLUE	GREEN	▶ 5 PER CASE.	
ITEM NO.	ITEM NO.	ITEM NO.	ITEM NO.	ITEM NO.	PRODUCT	EACH
H710 00381	H710 00321	H710 00311	5281 01241	H710 00301	Pails	\$49.77
H710 00361	H710 00371	H710 00351	H710 00341	H710 00331	Lids	22.21

NOTE: Optional lid available for all size pails, sold separately.



Measurements on inside.



No-drip spout and bottom handle are designed for easy pouring and dumping.

Stainless Steel Mounting Bracket



ITEM NO.	PRODUCT
5281 16201	Optional Bracket
EACH	
\$57.15	

Stainless Steel Pail

Heavy, 16-gauge type 304 stainless-steel polished finish inside and out.

- Welded construction, no crevices to collect dirt or bacteria.
- Smooth top edge. One piece chime, sealed around the bottom.



ITEM NO.	SIZE	WEIGHT	EACH
3013 20131	13 qt. Pail	4-1/2 lb	\$188.62
3013 20161	16 qt. Pail	5-1/2 lb	206.66

Stainless Steel Pail with Tilt Handle

Welded construction with no crevices.

- Heavy, 16-gauge type 304 stainless-steel polished finish inside and out.
- Ergonomic handle positioned for easy pouring.



ITEM NO.	SIZE	WEIGHT	EACH
3013 20141	13 qt. with Tilt Handle	4-1/2 lb	\$172.21
3013 20181	16 qt. with Tilt Handle	5-1/2 lb	193.37

Stainless Steel, 55-Gallon Process Drum

- Completely welded, open rim adds strength.
- ID: 21-1/2 inch dia. x 35-3/4 inches H.
- OD: 23-1/2 inch dia. x 36-1/2 inches H.
- Weight: 40 pounds.

NOTE: Stainless steel lid sold separately. SEE BELOW.



Welded lid hang hook.



1/2-inch diameter rod wear ring.

ITEM NO.	PRODUCT	EACH
2990 1389	Drum	\$1,457.95
2990 1390	Lid	275.25

Color-Coded Jugs

- Color-coded jugs decrease the risk of chemical accidents, cross-contamination and microbial contamination.



A. 2-1/2 Gallon

ITEM NO.	COLOR
H414 5028	Red
H414 5027	Pink
H414 5026	Orange
H414 5031	Yellow
H414 00011	Green
H414 5025	Blue
H414 5029	Tan
H414 5030	White

EACH \$65.95

B. 5 Gallon



ITEM NO.	COLOR
H414 00101	Red
H414 00161	Pink
H414 00121	Orange
H414 00131	Yellow
H414 00171	Green
H414 00141	Blue
H414 00151	Tan
H414 00111	White

EACH \$89.95



Round Poly Pails, 14 Quart

Perfect for any job.

- Convenient pouring spout molded in the side.
- Plastic construction resists acid, alkaline, chemicals and cleaning compounds.
- Insulated looped bail handle.

CONTINENTAL COMMERCIAL PRODUCTS®



ITEM NO.	COLOR
2760 14921	Gray
2760 14981	White

> 12 PER CASE.

EACH \$23.85



5-Gallon Food-Approved Plastic Bucket

- Lid available in white only and has tear-tabs for easier openings.
- 90 mil heavy-duty polyethylene.
- FDA compliant for contact with food products.



Buckets have child warning labels.

ITEM NO.	COLOR
2316 00231	White
2316 00221	Red
2316 00201	Blue
2316 00211	Green
2316 00241	Yellow
2316 00191	Black

▶ 12 PER CASE.

EACH
\$24.55

ITEM NO.	PRODUCT	EACH
2316 00181	Lid, White.	\$7.75

Aluminum Container Opener

Three light-weight aluminum tools in one!

1. Cutterhead cuts slotted covers safely.
2. Built in leverage handle easily opens plastic lids.
3. Quickly reseals ANY type of lid.



ITEM NO.	PRODUCT	EACH
6604 00261	Aluminum Container Opener	\$94.85

Pail Cover Remover

- Length: 12 inches.



ITEM NO.	PRODUCT	EACH
3247 24321	Plastic Cover Remover	\$16.95



6-Gallon Mop Pail with Lid

- Ideal for carrying soiled pads and cloths.
- Rugged poly carrying handle. • Rectangular shape.
- Capacity: 6 gallons (24 quarts). • Color: gray.



▶ SEE PAGES 118-123
For Mops and Accessories

▶ 12 PER CASE.

ITEM NO.	PRODUCT	DIMENSIONS	EACH
6387 19231	6-Gallon Mop Pail	20-1/2" x 10-1/2" x 11-1/4"	\$51.61



NOTE: Ideal for use with 18-inch wet mop pads, sold separately.

44-Gallon Drum with Venting Channels

Makes removing liners 50% easier!

- Innovative venting channels improve productivity and reduce the risk of injury. • NSF 2 and 21 approved.
- Integrated cinches secure the liner, allowing for efficient knot free liner changes. Tested to 20,000 cycles.



Optional self-draining lid.



Four liner cinches allow for efficient knot free liner changes.



Contoured base handles improve grip and efficiency while reducing strain.



Four patent-pending venting channels dramatically reduce the force required to remove a full can liner.

ITEM NO.	PRODUCT	EACH
1770 26611	Drum, Gray	86.65
1770 43611	Drum, Black	86.65
1770 43621	Drum, Blue	86.65
1770 43641	Drum, Yellow	113.30
1770 26601	Self-Draining Lid, Black	25.95

NOTE: Additional colors available. CALL FOR DETAILS.

Dome Lid

- For use on 44- and 55-gallon round brute drums.
- Heavy-duty plastic resists denting, bending or cracking.
- Hinged door swings shut automatically to trap odors.

NOTE: Pallet prices available. CALL FOR DETAILS.

ITEM NO.	SIZE	COLOR	EACH
1770 7753	44 Gallon	Red	\$160.55
1770 4788	44 Gallon	Gray	160.55
1770 0008	55 Gallon	Red	181.95
1770 4790	55 Gallon	Gray	181.95



Funnel Top Lid

- Allows hands free, no touch disposal.
- Crack-resistant plastic withstands indoor and outdoor use.
- Fits 32-gallon round drums only.



ITEM NO.	SIZE	COLOR	EACH
1770 79871	32 Gallon	Gray	\$65.25

▶ 6 PER CASE.

Imprinted Round Containers

Imprinted for clarity and easy identification.

- Each style is Hot Stamp imprinted with black 2-inch lettering.
- All drums are imprinted on 2 sides, in Spanish and English.
- Integrated ergonomic handles. • Unique base handles allow for easy lifting.
- Won't fade, warp, crack or crush. • NSF 2 and 21 certified.



20-Gallon Drums

▶ 6 PER CASE.

ITEM NO.	COLOR	IMPRINT	EACH
3414 01831	Yellow	CONDEMNED	\$39.34
3414 01821	Yellow	INEDIBLE	39.34
3414 01781	Gray	INEDIBLE	58.92

▶ SEE PAGE 258 and ABOVE For Lids, Sold Separately

NOTE: Custom Imprinted containers available by special order. CALL FOR DETAILS.

32-Gallon Drums

▶ 4 PER CASE.

ITEM NO.	COLOR	IMPRINT	EACH
3414 01661	White	EDIBLE	\$52.57
3414 01641	Yellow	CONDEMNED	55.30
3414 01751	Yellow	INEDIBLE	73.60
3414 01801	Yellow	TRASH	78.76
3414 01761	Red	CONDEMNED	52.57
3414 01651	Red	INEDIBLE	52.57
3414 0185	Red	TRASH	52.73
3414 01841	Blue	EDIBLE	52.57
3414 01811	Blue	TRASH	52.57
3414 01691	Gray	INEDIBLE	78.76
3414 01671	Gray	TRASH	52.57

44-Gallon Drums

▶ 3 PER CASE.

ITEM NO.	COLOR	IMPRINT	EACH
3414 01711	White	EDIBLE	\$79.51
3414 01721	Yellow	CONDEMNED	64.99
3414 01741	Yellow	INEDIBLE	64.99
3414 01791	Yellow	TRASH	64.99
3414 01861	Red	CONDEMNED	64.99
3414 01681	Red	INEDIBLE	64.99
3414 01731	Blue	TRASH	64.99
3414 0177	Gray	CONDEMNED	65.64
3414 01631	Gray	INEDIBLE	64.99
3414 01701	Gray	TRASH	64.99



Handle design eases lifting and prevents vacuum sealing when stacking.



Durable construction reinforced with drag skids for maximum longevity.



Integrated bag cinches.

Round Food-Approved Drums and Lids

- Durable construction reinforced with drag skids for maximum longevity. • Integrated ergonomic handles.
- Unique base handles allow for easy lifting. • Special features prevent vacuum sealing when nesting.
- Won't fade, warp, crack or crush. • NSF 2 and 21 certified.



10-Gallon Drums and Lids

WHITE	YELLOW	ORANGE	RED	PINK	PURPLE	BLUE	GREEN	GRAY	BLACK	▶ 6 PER CASE.	
ITEM NO.	ITEM NO.	ITEM NO.	ITEM NO.	ITEM NO.	ITEM NO.	ITEM NO.	ITEM NO.	ITEM NO.	ITEM NO.	PRODUCT	EACH
6387 24401	6387 24421	6387 24471	6387 24431	6387 24481	6387 24491	6387 24451	6387 24441	6387 24461	6387 24411	Drum	\$21.62
6387 24511	6387 24531	6387 24581	6387 24541	6387 24591	6387 24611	6387 24561	6387 24551	6387 24571	6387 24521	Lid	9.35

20-Gallon Drums and Lids

WHITE	YELLOW	ORANGE	RED	PINK*	PURPLE	BLUE	GREEN	GRAY	BLACK	▶ 6 PER CASE.	
ITEM NO.	ITEM NO.	ITEM NO.	ITEM NO.	ITEM NO.	ITEM NO.	ITEM NO.	ITEM NO.	ITEM NO.	ITEM NO.	PRODUCT	EACH
6387 24631	6387 24651	6387 25251	6387 24661	6387 25261	6387 25271	6387 24681	6387 24671	6387 24691	6387 24641	Drum	\$31.69
6387 24701	6387 24731	6387 24781	6387 24741	6387 24791	6387 24811	6387 24761	6387 24751	6387 24771	6387 24721	Lid	12.53

32-Gallon Drums and Lids

WHITE	YELLOW	ORANGE	RED	PINK*	PURPLE*	BLUE	GREEN	GRAY	BLACK	▶ 4 PER CASE.	
ITEM NO.	ITEM NO.	ITEM NO.	ITEM NO.	ITEM NO.	ITEM NO.	ITEM NO.	ITEM NO.	ITEM NO.	ITEM NO.	PRODUCT	EACH
6387 24831	6387 24851	6387 24901	6387 24861	6387 24911	6387 24921	6387 24881	6387 24871	6387 24891	6387 24841	Drum	\$42.08
6387 24941	6387 24961	6387 25081	6387 24971	6387 25101	6387 25151	6387 24991	6387 24981	6387 25071	6387 24951	Lid	16.62

44-Gallon Drums and Lids

WHITE	YELLOW	ORANGE	RED	PINK*	PURPLE*	BLUE	GREEN	GRAY	BLACK	▶ 6 PER CASE.	
ITEM NO.	ITEM NO.	ITEM NO.	ITEM NO.	ITEM NO.	ITEM NO.	ITEM NO.	ITEM NO.	ITEM NO.	ITEM NO.	PRODUCT	EACH
6387 32701	6387 32711	6387 32791	6387 32721	6387 25331	6387 25341	6387 32741	6387 32731	6387 32761	6387 14761	Drum	\$57.95
6387 25441	6387 25461	6387 25511	6387 25471	6387 25521	6387 25531	6387 25491	6387 25481	6387 25501	6387 25451	Lid	23.52

55-Gallon Drums and Lids

WHITE	YELLOW	ORANGE*	RED	PINK*	PURPLE*	BLUE	GREEN	GRAY	BLACK	▶ 2 PER CASE.	
ITEM NO.	ITEM NO.	ITEM NO.	ITEM NO.	ITEM NO.	ITEM NO.	ITEM NO.	ITEM NO.	ITEM NO.	ITEM NO.	PRODUCT	EACH
6387 05481	6387 09421	6387 25411	6387 09401	6387 25621	6387 05221	6387 09411	6387 55111	6387 55231	6387 15221	Drum	\$87.95
6387 25641	6387 25661	6387 25751	6387 25671	6387 25721	6387 25731	6387 25701	6387 25691	6387 25711	6387 25651	Lid	34.94

*Certain sizes of orange, pink and purple drums and lids are available by special order. Minimum quantities apply. Ask your CSR for details.

Heavy-Duty Industrial Liners

Coreless rolls packed in an easy-to-use dispenser case.

- Strong, low-density bags are ideal for wet trash and heavy loads.
- Black color bags hide unsightly garbage.
- Six gussets for added strength.



ITEM NO.	CAPACITY	SIZE	MIL	BAGS/CASE	CASE
7600 4265	20-30 Gallon	30" x 36"	0.9	200	\$66.28
7600 4270	32 Gallon	33" x 39"	1.3	100	61.45
7600 4275	44 Gallon	40" x 46"	1.3	100	74.12
7600 4281	56 Gallon	42" x 47"	1.3	100	85.39
7600 4293	60 Gallon	38" x 58"	1.3	100	90.07

2.5 Mil Steel Blue Super Heavy-Duty Coreless Can Liner

The toughest liner you can buy at any price!

- Made from super hexene resin.
- Perforated, coreless roll.
- Gauge: 2.5 mil. • Color: dark blue.



No-burst bag stretches where other bags tend to break!



ITEM NO.	CAPACITY	SIZE	BAGS/CASE	CASE
6160 6440	33 Gallon	33" x 40"	100	\$103.67
6160 6448	45 Gallon	40" x 48"	50	78.45
6160 4860	60 Gallon	38" x 58"	50	90.68

DrawTape Coreless Can Liners

Pull drawtape to close, easy to lift and carry.

- Maximum efficiency — eliminates bag tie-offs.
- Made from premium LLDPE resins for superior puncture and tear resistance.
- Tough seamless bottom for extra strength.
- Interleaf coreless rolls.



ITEM NO.	CAPACITY	SIZE	MIL	COLOR	BAGS/CASE	CASE
2266 2638	23 Gallon	26-1/2" x 38"	1.1	White	200	\$83.35
2266 2840	23 Gallon	26-1/2" x 38"	1.2	White	200	108.25
2266 3338	32 Gallon	33" x 38"	1.1	Clear	200	98.12
2266 3747	44 Gallon	37" x 45"	1.4	Black	100	87.54
2266 4044	55 Gallon	40-1/2" x 45"	1.4	Black	100	94.49

High-Density Economy Liners

Coreless rolls packed in an easy-to-use dispenser case.

- Perforated coreless rolls are time saving, cost efficient and easy to dispense.
- Clear, puncture resistant bags are perfect for light loads.
- Star-seal bottom.



ITEM NO.	CAPACITY	SIZE	GAUGE	BAGS/CASE	CASE
7500 4857	12-16 Gallon	23" x 33"	5 Microns	1000	\$59.07
7500 4862	20-30 Gallon	30" x 36"	13 Microns	250	63.85
7500 4860	20-30 Gallon	30" x 36"	8 Microns	500	63.73
7500 4869	33 Gallon	33" x 39"	14 Microns	250	65.36
7500 4867	33 Gallon	33" x 39"	12 Microns	250	57.77
7500 4884	40-45 Gallon	40" x 46"	14 Microns	250	88.19
7500 4874	60 Gallon	38" x 57"	19 Microns	150	85.05
7500 4872	60 Gallon	38" x 57"	12 Microns	200	71.47
7500 4889	56 Gallon	42" x 47"	14 Microns	200	71.47

Caddy Bag

Turn your drum and dolly into a mobile cleaning station.

- 7-pockets and 5-elastic pouches designed to hold brushes, sponges, chemicals and other cleaning utensils (sold separately).
- Buckle and straps attach caddy to handles, while strong Velcro® affixes the bottom of caddy to brute.
- Caddy fits 32 and 44 gallon capacity brutes.



NOTE: Supplies, drum and dolly sold separately.



▶ 6 PER CASE.

ITEM NO.	PRODUCT	SIZE	EACH
1770 77361	Caddy Bag	20" x 20-1/2"	\$77.75

Stainless Steel Drum Backsplash

- 18-gauge stainless steel.
- Wrap around design keeps floors and walls clean.
- Fits 32-, 44- and 55-gallon round trash cans.
- Nesting design allows room for inside can liner.
- Dimensions: 18 inches H x 38 inches W.

Five stainless steel tabs hold backsplash securely in place.



ITEM NO.	PRODUCT	F.O.B. FACTORY EACH
2510 18381	Stainless Steel Backsplash	\$141.15

2- and 3-Can Aluminum Trash Trucks

No more dragging trash cans across the floor, creating the potential for spills and safety hazards.

- Trash Trucks can accommodate two or three 32-gallon trash cans at once.
- The push/pull handle and casters allow for versatile movement even in tight spaces.
- Four 5-inch plate type casters; two swivel, two rigid.
- Available in 2- or 3-trash can capacities.



A



B

NOTE: Images shown with 32-gallon round trash cans, not included.

ITEM NO.	PRODUCT	DIMENSIONS	CAPACITY	SHIP. Wt.	EACH
3775 0097	A. 2-Can Trash Truck	26" x 35" x 57"	1,000 lb	71 lb.	\$669.92
3775 0098	B. 3-Can Trash Truck	26" x 35" x 73"	1,000 lb	90 lb.	797.64

Round Twist-On Dolly

- May be permanently attached to drum.
- Dolly height: 5 inches.
- Round twist-on dolly fits 20-, 32-, 44- and 55-gallon round drums.



- Riveted casters.
- Wheels are NOT replaceable.



▶ 2 PER CASE.

ITEM NO.	PRODUCT	CAPACITY	EACH
6387 33171	Round Twist-On Dolly	250 lb.	\$50.15

Tandem Drum Dolly

- Carries two drums at one time.
- Heavy-duty 8 wheels and swivel casters allow easy mobility.
- Hinge in the center allows one side to fold up for easy storage or for transporting only one drum.
- Fits 20-, 32-, 44- and 55-gallon round drums.



NOTE:
Drums sold separately.

ITEM NO.	PRODUCT	CAPACITY	EACH
1770 3538	Tandem Dolly	200 lb.	\$250.65
3414 1739	Replacement 2 Wheels and Axle		51.56
3414 1112	Replacement 4" Non-Marking Plate Swivel Caster		32.33

Universal Dolly

Makes moving drums around the plant easy!

- Universal dolly fits all 10- through 55-gallon drums.
- Includes heavy-duty swivel casters to enhance mobility.
- Dimensions: 24-3/4 inches W x 7-1/8 inches H.
- Load capacity: 500 pounds.
- Color: black.



ITEM NO.	PRODUCT	EACH
1770 77581	Round Universal Dolly	\$184.15
3414 0004	Replacement 3" Swivel Casters	18.52

MegaSteady Drum Dolly

- Five wheel, pentagon shaped dolly for super steady rolling.
- Heavy-duty 3-inch wheels and swivel casters allow easy mobility.
- Holds 20-55-gallon sizes of round drums.
- Capacity: 625 pounds.

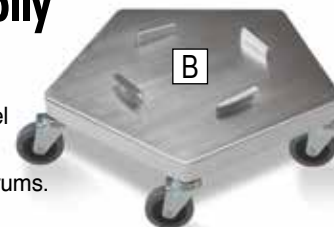

B



A

ITEM NO.	PRODUCT	EACH
2510 0319	A. Aluminum, MegaSteady Drum Dolly	\$86.95
3013 0025	B. Stainless Steel Drum Dolly	290.05

Square Food-Approved Drums

All the features of our round drums, plus space efficient square brutes provide 14% more capacity.

- Gray and White are USDA Meat and Poultry Equipment Group Listed and assist in complying with HACCP guidelines.
- Rounded corners and smooth contours are easy to clean. • Certified to NSF Std. #2 (gray and white) and Std. #21.
- Nesting handles allow secure fit for side-by-side use.



ITEM NO.	PRODUCT	DIMENSIONS	EACH
1770 08261	Drum, 28 Gallon (6/Case)	21-1/2" x 21-1/2" x 22-3/5"	\$84.55
1770 89551	Lid, 28 Gallon (6/Case)	22-1/2" x 22-1/2" x 2"	27.75
1770 35421	Drum, 40 Gallon (4/Case)	23-1/2" x 23-1/2" x 28-4/5"	90.95
1770 79801	Lid, 40 Gallon (4/Case)	24" x 24" x 2"	28.95

Square Twist-On Dolly

- All plastic, professional-grade construction resists rust, chipping and denting.
- Heavy-duty wheels with swivel capabilities provide for ease of mobility.
- Square twist-on dolly fits both the 28- and 40-gallon square drums.
- May be permanently attached to drum.
- 17-1/5 inches L x 17-1/5 inches W x 6-1/5 inches H.
- Capacity: 300 pounds.



▶ 2 PER CASE.

ITEM NO.	PRODUCT	EACH	ITEM NO.	PRODUCT	EACH
1770 01201	Twist-On Dolly	\$129.55	3414 5234	3" Replacement Casters	\$14.03

Rollout Containers

The largest portable trash containers we sell!

- Rotationally molded, one-piece construction for superior durability.
- Ground-hugging base is designed for stability.
- Lifter bar on (65- and 95-gallon models) is compatible with semi-automated lifting systems.
- Non-slip handle and foot tilter are designed to maneuver heavy loads.
- 50 gallon: 8-inch rubber tread wheels; 65 and 95 gallon: 10-inch rubber tread wheels, both with steel axle to easily roll over rough surfaces and are inset to avoid damage to walls and doors.
- Stackable lid design.



ITEM NO.	PRODUCT	COLOR	DIMENSIONS	EACH
1770 92551	50 Gallon	Gray	28-1/2" x 23-2/5" x 36-1/2"	\$282.25
1770 95291	50 Gallon	Blue, Recycle	28-1/2" x 23-2/5" x 36-1/2"	234.45
1770 9260	65 Gallon	Gray	32-3/10" x 25-1/4" x 41-4/5"	266.65
1770 9127	95 Gallon	Blue	32-2/5" x 27-3/10" x 45-3/5"	389.95

The Glutton®

Perfect for large crowds and high traffic areas.

- Designed to withstand extreme weather and handling.
- Hooded top provides added strength.
- Tough easy-to-clean container.
- Capacity: 56 gallons.

NOTE: Container and lid sold separately.



ITEM NO.	PRODUCT	COLOR	DIMENSIONS	EACH
1770 72561	A. 56-Gallon Container	Off-White	25-1/2" x 22-3/4" x 31-1/10"	\$289.05
1770 7646	B. Hooded Top w/o Doors. . . .	Red	26-3/5" x 23" x 13"	299.85
1770 7647	C. Hooded Top w/o Doors. . . .	Brown	26-3/5" x 23" x 13"	350.75

Dome Lid Trash Can

Rugged enough to withstand demanding temperatures and weather extremes.

- One-piece durable plastic construction features a snug-fit hinged top with gravity closure door and a bag holder for easy maintenance and neatness.
- Resists corrosion and maintains appearance year after year.
- UL rated Fire Resistant and Factory Mutual approved for fire safety.
- Under normal use with top on and lid closed, the container will restrain flames and even extinguish them.
- Color: brown.



ITEM NO.	PRODUCT	DIMENSIONS	EACH
1770 9402	15 Gallon	15-2/5" x 36-1/2"	\$267.75
1770 6094	25 Gallon	18" x 24"	353.35

Untouchable®

Comply with HACCP with a hygienic, hands-free refuse disposal.

- Durable crack resistant plastic stands up to the toughest treatment.
- Open top allows waste to be disposed of without container contact.



ITEM NO.	PRODUCT	COLOR	DIMENSIONS	EACH
1770 26941	A. 23-Gallon Lid	Black	14-9/10" x 14-9/10" x 4-1/2"	\$48.15
1770 69881	23 Gallon Container	Gray	14-1/2" x 14-1/2" x 28"	107.05
1770 02661	B. 50-Gallon Lid	Gray	20-1/10" x 20-1/10" x 6-1/4"	107.05
1770 39601	50 Gallon Container	Gray	19-1/2" x 19-1/2" x 27-3/4"	259.15

Heavy-Duty, Stainless Steel Knockdown Trash Liner Holder

- Fits 32- and 44-gallon liners. • Made of 16-gauge, T304 stainless steel.
- Dimensions: Upper ring: 44-1/2 inches ID; Lower ring: 37 inches ID.
- Easy to assemble, no tools required.
- Height: 42 inches. • Weight: 4 pounds.



ITEM NO.	PRODUCT	EACH
2990 21061	Stainless Steel Knockdown Trash Liner Holder	\$270.00



Trimline™ Waste Containers

- Integrated tabs prevent liners from slipping into container.
- Optional swing lid conceals trash while providing easy touch-free access.
- Hand grips on container bottom simplify lifting and emptying.
- Textured surface resists scuffs and marking.
- Smooth inner surface is easy to clean.
- Slim rectangle waste container fits neatly in narrow spaces.
- Capacity: 23 gallons.
- Dimensions: 20 inches L x 11 inches W x 30 inches H.

NOTE: Containers and lids sold separately.

Containers

ITEM NO.	COLOR
6387 32951	Brown
6387 23121	Black
6387 32931	Beige
6387 23111	Green
6387 14671	Blue
6387 14441	Gray

▶ 4 PER CASE.

EACH
\$56.12



Lids

ITEM NO.	COLOR
6387 14681	Brown
6387 32961	Black
6387 14711	Gray

▶ 4 PER CASE.

EACH
\$58.96

Beige, green, and blue lids not available.



Cigarette Butt Receptacle

- Cease-Fire® design limits the flow of oxygen to safely and quickly extinguish cigarettes to reduce the risk of fire — and prevents “chimney effect”.
- Covered 1-1/2-inch opening keeps rain out and discourages trash from being dropped in.
- Large, 16-quart galvanized steel liner pail removes for easy cleaning.
- Large internal neck cavity minimizes clogging.
- Dimensions: 16-1/2 inch dia. x 38-1/2 inches H.

ITEM NO.	PRODUCT	EACH
B616 0010	Cigarette Butt Receptacle	\$120.85

28-Quart Waste Bins®



Classic space saving, cost efficient design.

- Easily fits underneath standard desk height.
- All-plastic construction won't dent, chip or rust.
- Rolled rims add strength and are easy to clean.
- Dimensions: 14-3/8 inches L x 10-1/4 inches W x 15 inches H.

▶ 12 PER CASE.

ITEM NO.	PRODUCT	COLOR	EACH
1770 29561	Recycle Bin	Blue	\$14.95
1770 08481	Waste Bin	Gray	16.05



SHOP 24/7
bunzlpd.com

Need Help?
Chat With Us
Online!

CHAT

STAY CONNECTED WITH US:

Where you can find out what's on sale, find updated product information, reviews and pricing.

SHOP 24/7 bunzlpd.com

Where you can find out what's on sale, find updated product information, reviews and pricing.



STAY CONNECTED WITH US:



Need Help?
Chat With Us
Online!



ERGONOMICS

FIND IT FAST

Back Supports	266-267
Nifty Nabber® All-Purpose Grabber.	267
Wrist and Elbow Supports	268
Knee Pads	269
Floor Grating and Stands.	269
Floor Mats, Wall Rack and Clean-Up Cart.	270-271
Anti-Fatigue Mats	270-271
Entrance Mats	270-271
Boot Dip Mat.	271



Back Support

SupportBand elastic provides extra support where you need it most.

- Durable, breathable light-weight woven nylon outer stands up to tough use.
- Machine wash, line dry. • Color: black.

SUPPORTBAND

Heavy elastic side adjustments overlap front for extra support with heavy-duty Velcro® closure.



Support Plus®

Traditional back support with the "PLUS" of a removable lumbar pad for extra support and comfort.



Back Support with Foam Lumbar Pad

Foam lumbar pad is orthopedically designed to mold perfectly to the shape of the lower back.

- 1-inch wide easily released Velcro® suspenders.



Foam lumbar pad.



ITEM NO.	SIZE
3245 0382	Small, 24"-33"
3245 0383	Medium, 29"-38"
3245 0384	Large, 35"-44"
3245 0385	X-Large, 42"-52"
3245 0386	2X-Large, 46"-56"

EACH
\$43.35

Cool-Weave Back Support Belt

Cool and comfortable without suspenders.

- Patented Sta-Put™ belt loops and four internal gripper strips keep belt in place.
- Velcro® front closure with ventilated 8-inch back.
- 5-inch front, 8-inch back.

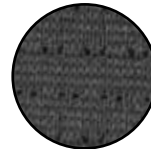

Cool-weave material.



ITEM NO.	SIZE
3264 07311	Small, 32"-36"
3264 07321	Medium, 36"-40"
3264 07331	Large, 40"-48"
3264 07341	X-Large, 48"-52"

▶ 6 PER CASE.

EACH
\$30.85

ProFlex® 2000SF High-Performance Back Support

Flexible, secure fit gives maximum abdominal and low back support.

- Light-weight, breathable 840D spandex and elastic, dries quickly and holds its shape.
- Adjustable elastic suspenders for a more comfortable fit.
- Patented Power Panel Positioners™ keep elastic bands close to sides for ease of use.
- Panels will not fall out of reach when not in use.
- Machine washable. • Color: black.

ITEM NO.	SIZE
3321 29021	Small, 25"-30"
3321 29031	Medium, 30"-34"
3321 29041	Large, 34"-38"
3321 29051	X-Large, 38"-42"
3321 29061	2X-Large, 42"-46"

EACH
\$62.95

Two-stage elastic closure, with hook and loop fasteners, allows quick adjustment from cinched to relaxed position.

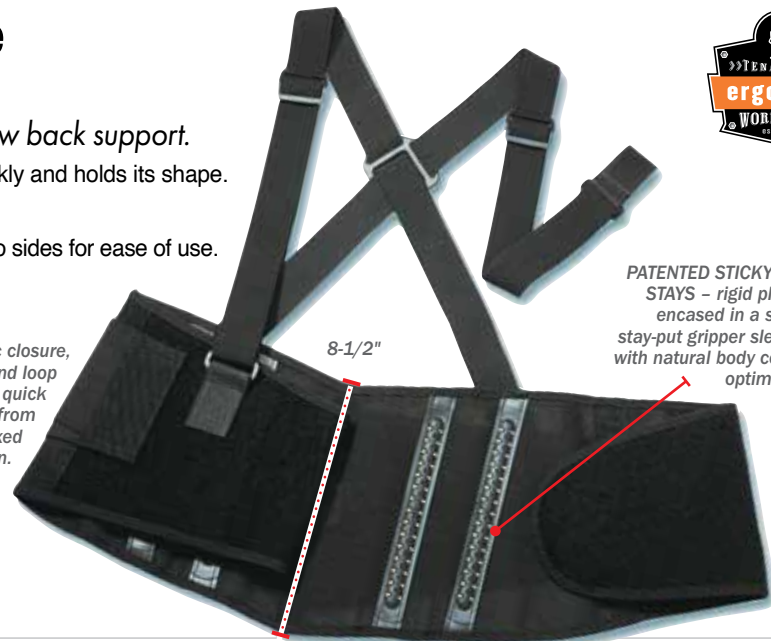

PATENTED STICKY FINGERS® STAYS – rigid plastic stays encased in a soft rubber, stay-put gripper sleeve, flexes with natural body contours for optimal support.



NiftyNabber®

The all-purpose grabber. For universal trash removal (cans, paper, bottles, hazardous items) and out-of-reach items.

- No bending, no backaches — out-of-reach items can be easily removed from floors or high-access areas.
- Light-weight, durable tool — grab items securely and comfortably.
- Powerful claws grip even small and oddly-shaped objects.
- Available in two lengths: 36 inches and 51 inches.



Quality Tools for Smart Cleaning™

ITEM NO.	PRODUCT	EACH
7035 00901	36" Length	\$49.45
7035 01401	51" Length	61.25

ProFlex® 4020 Wrist Support



- Light-weight, neoprene construction provides a snug, secure, custom fit.
- Patented Open-Center Stay™ reduces pressure on median nerve.
- Palm side of support offers minimum bulk along with ventilation holes.



NOTE: To assure a correct fit, measure around hand at widest part of palm.

RIGHT HAND ITEM NO.	LEFT HAND ITEM NO.	SIZE	WRIST	EACH
3321 07931	3321 00071	XS/Small . . .	Up to 6" . . .	\$20.57
3321 07941	3321 00081	Medium . . .	6"-7"	20.57
3321 07951	3321 00091	Large/XL . . .	7"-8"	20.57

ProFlex® 4000 Single Strap Wrist Support



- Limit movement and encourage neutral wrist position.
- Two-stage closure for an exact fit, allowing free finger and thumb movement.
- Lining pulls moisture away to protect against odor and bacteria build-up.
- Single strap design protects wrist from above.
- Machine washable, line dry.



Patented Open-Center Stay™ reduces pressure on median nerve.

RIGHT HAND ITEM NO.	LEFT HAND ITEM NO.	SIZE	WRIST	EACH
3321 20701	3321 00111	Small	Up to 6" . . .	\$23.89
3321 20711	3321 00101	Medium . . .	6"-7"	23.89
3321 20721	3321 00121	Large	7"-8"	23.89

ProFlex® 670 Ambidextrous Wrist Support



- Single layer of durable neoprene conforms to the wrist and provides warmth to affected area.
- Hook-and-loop closure adjust for a comfortable fit.
- Removable two-inch woven elastic strap for added support.
- Machine washable.



ITEM NO.	SIZE	PALM
3321 0670	Small	7"-8"
3321 0671	Medium	8"-9"
3321 0672	Large	9"-10"
3321 0673	X-Large	10"-11"
EACH		\$15.05



ProFlex® 500 Elbow Support

- Reduces risk of injury in jobs that require repetitive arm motion.
- Constructed of nylon-laminated neoprene with adjustable cinch strap with hook and loop fastener.
- Machine washable, line dry.

NOTE: To assure a correct fit, measure around the widest part of forearm just below the elbow.



ITEM NO.	SIZE	FOREARM	EACH
3321 20651	Small	9"-10"	\$17.75
3321 20661	Medium	10"-11"	
3321 20671	Large	11"-12"	

ProFlex® 650 Slip-On Elbow Sleeve



- Neoprene four-way stretch fabric provides uniform support and warmth.
- Conforms to the body's natural shape.
- Body-side surfaces are treated to inhibit bacterial growth.
- Ambidextrous.



ITEM NO.	SIZE	EACH
3321 0650	Small	\$16.29
3321 0651	Medium	
3321 0652	Large	
3321 0653	X-Large	
3321 0654	2X-Large	

ProFlex® 420/400 Wrist Wraps



- Provide wrist support while lifting or during strenuous or repetitive activities.
- Available with or without thumb loops.
- Machine washable.
- Colors: black or tan.
- Size: L/XL

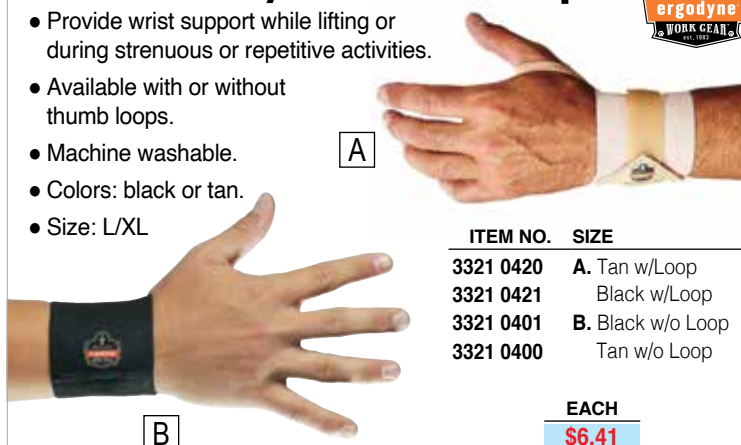

ITEM NO.	SIZE	EACH
3321 0420	A. Tan w/Loop	\$6.41
3321 0421	Black w/Loop	
3321 0401	B. Black w/o Loop	
3321 0400	Tan w/o Loop	

ProFlex® 300/315 Hard Cap Knee Pads

- Available with a long, textured hard cap for tough environments, or a short round hard cap for applications that require swiveling and pivoting.
- Light-weight contoured 12 mm NBR foam protects sensitive knee joints.
- Abrasion-resistant hard caps. • Woven elastic straps adjust to an exact fit.
- Buckle closures.



ITEM NO.	PRODUCT	PAIR
3321 0315	A. Long, Textured	\$41.75
3321 0300	B. Round, Smooth	41.75

ProFlex® 230 Soft Buckle Knee Pads

- Constructed with 15 mm closed cell foam padding and durable covers.
- Wider and longer padding for wrap-around comfort.
- Buckle closure won't snag on carpet or pick up grime.



ITEM NO.	PRODUCT	PAIR
3321 0230	One Size Fits All	\$23.05

ProFlex® 260 Slip-On Soft Knee Pads

- Light-weight contoured foam covered with durable fabric protects sensitive knee joints. • Easy on and off.



ITEM NO.	PRODUCT	PAIR
3321 0260	One Size Fits All	\$17.15

Ergo Stands

Help level the height difference among workers at shared workstations — creating a comfortable, ergonomic working position.

- Punched anti-slip deck for maximum traction reduces slips and falls from wet or slippery floors.
- Constructed of solid, fully welded rust-free aluminum.
- Available in 5 heights.



Anti-slip deck for maximum traction.

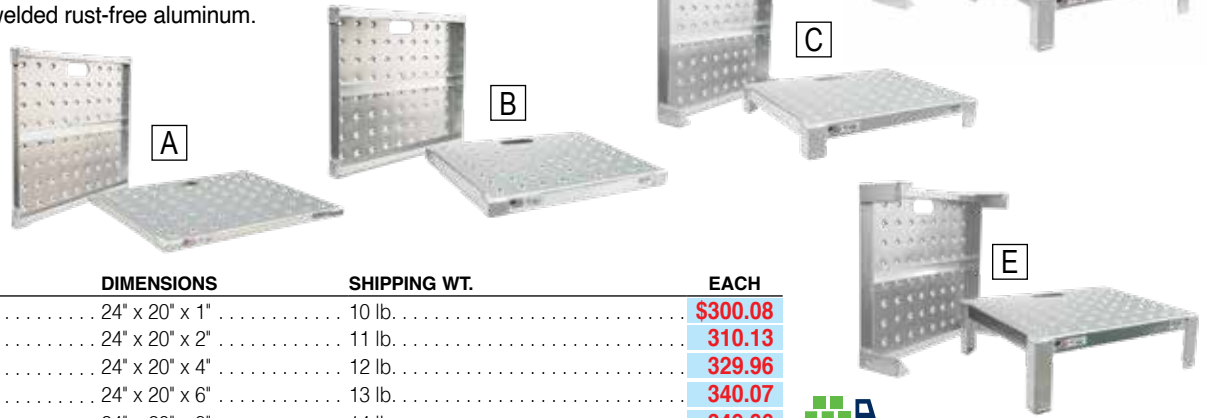

ITEM NO.	PRODUCT	DIMENSIONS	SHIPPING WT.	EACH
3775 00861	A. 1" Ergo Stand	24" x 20" x 1"	10 lb.	\$300.08
3775 00891	B. 2" Ergo Stand	24" x 20" x 2"	11 lb.	310.13
3775 00881	C. 4" Ergo Stand	24" x 20" x 4"	12 lb.	329.96
3775 00871	D. 6" Ergo Stand	24" x 20" x 6"	13 lb.	340.07
3775 0090	E. 8" Ergo Stand	24" x 20" x 8"	14 lb.	349.86



Ergo2000 Stands with KorDek-II Grating

- Fiberglass grate is gritted on both sides and can be used with or without the stainless steel stand for a comfortable anti-slip surface.
- Stainless steel frame with a load capacity of 900 pounds.
- Stand is adjustable from 4-1/4 inches to 17-1/4 inches.



ITEM NO.	PRODUCT	SHIPPING WT.	F.O.B. FACTORY EACH
3523 6543	Ergo2000 2' x 4' Stand (includes grating).	125 lb.	\$1,975.56



Floor Mats with Built-In Connectors

The ultra-flexible floor mat made for connecting.

- Built-in molded connector strip allows mats to be connected, so that there are no gaps on which to trip.
- Raised, nubby backing enhances drainage and sanitation, adds cushion and eliminates sliding.



Safety-Step™ Rubber Floor Mats

ITEM NO.	SIZE	THICKNESS	SHIPPING WT.	F.O.B. FACTORY EACH
4480 0750	36" x 36"	5/8"	21 lb.	\$52.45
4480 0035	36" x 60"	5/8"	32 lb.	73.45

Dura-Step™ Grit-Coated, Grease Proof Floor Mat

ITEM NO.	SIZE	THICKNESS	SHIPPING WT.	EACH
4480 3753	36" x 36"	5/8"	20 lb.	\$165.42



Dura-Step™ Grit-Coated mat.

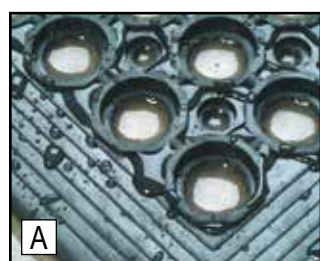

Safewalk-Light™ Anti-Fatigue Floor Mat with Beveled Edge

For indoor use only.

- 1/2-inch thick mat has beveled edges on all sides to prevent tripping and to facilitate movement of wheeled carts.
- Raised blocks on underside allow water to flow easily for quick clean up.

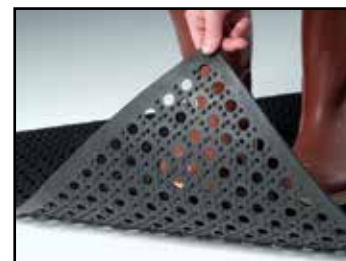

A. General-Purpose Black Floor Mat

ITEM NO.	SIZE	THICKNESS	SHIPPING WT.	EACH
4480 0354	36" x 60"	1/2"	26-1/2 lb	\$52.45

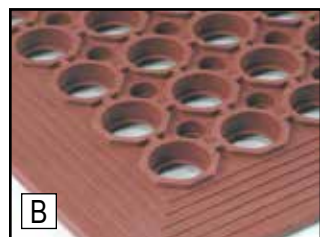

B. Grease-Resistant Terra Cotta Floor Mat

ITEM NO.	SIZE	THICKNESS	SHIPPING WT.	EACH
4480 0005	36" x 60"	1/2"	26-1/2 lb	\$83.95



Aluminum Floor Mat Clean-up Cart

- Heavy-duty anti-slip plank style deck.
- Holds up to eighteen 5/8-inch anti-fatigue floor mats (sold separately).
- Capacity: 450 pounds. [▶ SEE PAGES 257-258 For Drums](#)

NOTE: Shown with 36-inch square mats and 44-gallon drum, sold separately.



4" x 2" wheels on 2-locking and 2-swivel casters.



1/2" rods hold mats for cleaning and transport.



Easy to attach clamps make assembly easy.



ITEM NO.	PRODUCT	DIMENSIONS	EACH
2510 4636	Mat Cart	34" x 46" x 36"	\$574.45



Safewalk™ Floor Mat

- Mats have brightly-colored, highly visible, beveled yellow borders on four sides to increase safety and identification.
- Constructed of heavy-duty rubber with vinyl borders for use in wet or dry environments.
- Excellent drainage, aeration, traction and comfort.
- Thickness: 7/8 inch.

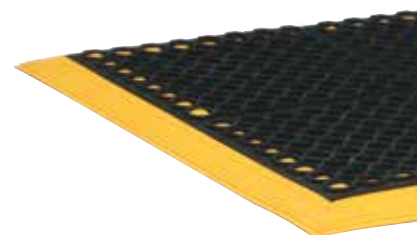

ITEM NO.	SIZE	SHIPPING WT.	EACH
4480 0426	28" x 40"	20 lb.	\$94.45
4480 0440	40" x 40"	28 lb.	219.13
4480 0464	40" x 64"	43 lb.	279.81

Wall Mount Mat Rack

Space-saving rack allows mats to be hung vertically, to maximize airflow and facilitate faster drying.

- Rust-free aluminum construction allows mat to be cleaned by power washing.
- Free up floor space when not in use.



ITEM NO.	SIZE	SHIPPING WT.	EACH
3775 0099	42" x 7" x 10"	17 lb.	\$339.70

Raised Knob Entrance Mat

- Beveled edges reduce tripping hazard.
- Easy to clean.
- Color: black.
- Thickness: 5/8 inch.

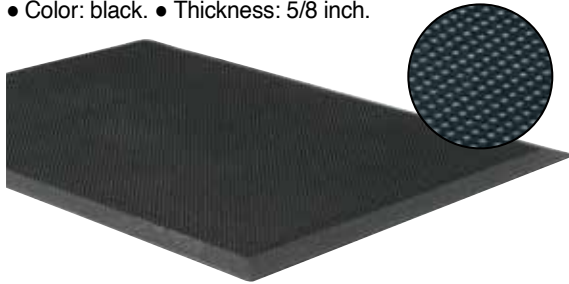

ITEM NO.	SIZE	EACH
4480 0254	24" x 32"	\$52.45

Foam Rubber Anti-Fatigue Mat

- Ideal for use as a workstation mat to reduce leg and back stress on workers who stand for prolonged periods of time.

- Constructed of closed cell foam rubber with a textured surface providing slip-resistant footing.

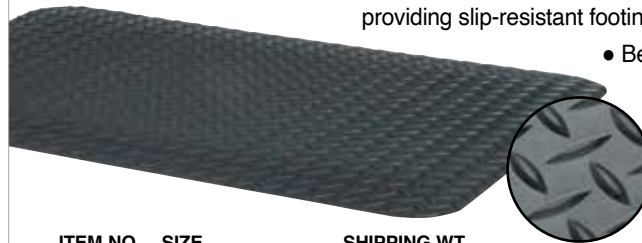

- Beveled edges reduce tripping.
- Thickness: 9/16 inch.

ITEM NO.	SIZE	SHIPPING WT.	EACH
4480 0489	24" x 36"	7 lb.	\$41.95

Foam Anti-Fatigue Mat

- Durable, abrasion-resistant surface is wear-bonded to a highly-ergonomic Zedlan foam with a pebble surface texture.



- For use in medium-duty, dry areas.
- Mat grip pattern provides non-slip surface.
- Wear-bonding process bonds layers together without the use of adhesives.
- Thickness: 1/2 inch.

ITEM NO.	SIZE	SHIPPING WT.	EACH
4480 0057	24" x 36"	5-1/2 lb	\$52.45

Diamond-Style Entrance Mat

Perfect for heavy, multi-directional traffic.

- Ultra-dense, charcoal colored polypropylene fiber construction that dries quickly and maintains its color.

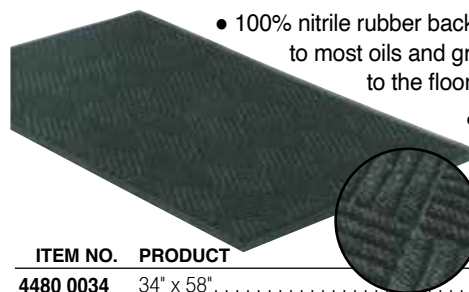

- 100% nitrile rubber backing makes mat impervious to most oils and grease and keeps it anchored to the floor.
- Edges retain water and dirt to keep the surrounding floor clean and dry.
- Thickness: 3/8 inch.

ITEM NO.	PRODUCT	EACH
4480 0034	34" x 58"	\$157.50
4480 0038	45" x 70"	252.00

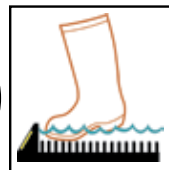

Solution covers sole, sides and arch area of boot.

For Recommended Chemicals ▶ SEE PAGE 145

High-Wall Disinfectant Boot Dip Mat

Two-inch wall height guarantees solution will cover sole, sides and welt/arch area of boot.

- Mixed with water, one bottle makes 64 gallons — enough to fill mats over 11 times!
- Use wherever cross-contamination is a concern.
- Holds up to 22 quarts of solution.

ITEM NO.	PRODUCT	DIMENSIONS	EACH
4480 3239	Boot Dip Mat	32" x 39" x 2"	\$115.45



WorkHorse[®] SAFETY GLASSES

The #1 Choice for the Food Processing Industry.

SAFETY

FIND IT FAST

Sqwincher Hydration Mix	274-275
Lockout/Tagout	276-279
Padlocks and Security Locks	280
Anti-Slip Tapes and Compounds	280-281
Medical and First Aid Kits	282-283
Medical Supplies	284-288
Eyewash Stations	289
Eye Protection	290-298
Face Shields	299
Ear Protection	300-310
Head Protection and Accessories	311-314
Fall Prevention	314-315
Hi-Viz Safety Jackets and Vests	316-317
Respirators and Masks	318-324
Cut Resistant Gloves	326-331
Safety Aprons	332-333
Arm and Foot Protection	334-335
Welding Protection	336





Sqwincher is one of the most cost-effective ways of increasing productivity, while helping lower the number of workplace accidents. Just like hard-working machinery, bodies need fuel. And to ensure peak performance, your employees need fuel that works as hard as they do, with a taste that keeps them revved up for more. Research shows that a high number of work-related accidents are attributed to “bad judgment” or failure of safety equipment, when, in fact, heat stress and fatigue may actually be the cause. Stop heat stress before it starts.

MAXIMIZE EMPLOYEE PRODUCTIVITY in Hot Environments.



Sqwincher is focused on the INDUSTRIAL ATHLETE who is performing in extreme conditions for 8-12 hours, 5 to 7 days a week. Contains 50% less sodium and 50% more potassium than other sports drinks.

Powder Pack™, 2-1/2 Gallons

- Full of electrolytes which stimulate rapid fluid absorption and quickly replace elements lost in sweat.
- Low sodium. • No caffeine. • Gluten free.
- One packet makes 2-1/2 gallons.

ITEM NO.	COLOR
3317 4854	Lemonade
3317 4856	Orange
3317 0035	Cool Citrus
3317 4857	Fruit Punch
3317 6046	Grape
3317 0033	Mixed Berry
3317 0030	Assorted Variety Pack

▶ 32 PACKS PER CASE.

CASE
\$159.24



NOTE: Sold by case only.

Sugar Free Zero Powder Pack™, 2-1/2 Gallons

- Designed to replace fluids and elements lost due to perspiration with 0 sugar, 0 calories, and an optimal blend of electrolytes.
- Low sodium. • No caffeine. • No sugar.
- One packet makes 2-1/2 gallons.

NOTE: Sold by case only.

ITEM NO.	COLOR
3317 6800	Lemon-Lime
3317 6801	Orange
3317 6803	Fruit Punch
3317 6802	Assorted

▶ 32 PACKS PER CASE.

CASE
\$144.28



Qwik Stik™ Zero, 20 Ounces

Just pour, shake and drink!

- Single-serve pouch is designed to be poured directly into a 20-ounce bottled water.
- No sugar. • No Calories. • Gluten-free.

ITEM NO.	COLOR
3317 0122	Lemonade
3317 0119	Orange
3317 0121	Fruit Punch
3317 0120	Mixed Berry
3317 1107	Grape

▶ 500 PACKS PER CASE.

CASE
\$226.91



NOTE: Sold by case only.

Sqwincher® Freezer Squeeze Pops

- Assorted flavors per pack: Mixed Berry, Orange, Lemon Lime, Grape and Cherry.
- Each freezer pop contains 25 mg of sodium and 15 mg of potassium.
- Store in freezer.

NOTE: Sold by case only.

▶ 10 POPS PER PACK - 15 PACKS PER CASE.

ITEM NO.	PRODUCT	CASE
3317 0128	Squeeze Pops	\$56.81





Sqwincher® 5-Gallon Insulated Cooler

- Convenient spigot for dispensing.
- Includes two, easy-to-carry side handles.

ITEM NO.	PRODUCT	EACH
3317 01431	5-Gallon Cooler	\$59.45

Paper Cone Cups

- The ideal cup for on-the-go environments.



► 5,000 PER CASE.

ITEM NO.	PRODUCT	CASE
1820 8203	4 oz. Cups	\$159.75

SHOP 24/7
bunzlpd.com



**Need Help?
 Chat With Us
 Online!**

STAY CONNECTED WITH US:



Where you can find out what's on sale, find updated product information, reviews and pricing.



**Master
Lock**



Personal Electrical Lockout Kit

Carrying case keeps important lockout devices and padlocks together.

- Padlocks are keyed-alike for added worker convenience.
- Kit contains Zenex™ non-conductive, light-weight padlocks with write-on labels.

Set includes:

- (3) Zenex™ Padlocks
- Circuit Breaker Padlock
- Hasp
- Snap-On Hasp
- Single Pole Breaker Lockout Device

- (2) "No Hole", 227 Volt Breaker Lockout Devices
- "No Hole", 480/600 Volt Breaker Lockout Device
- Universal Multi-Pole Breaker Lockout Device

- Wall Switch Lockout
- (12) "Do Not Operate" Tags

ITEM NO.	PRODUCT	EACH
3198 0070	Personal Electrical Lockout Kit	\$204.95

Group Electrical and Valve Lockout Kit

Carrying case contains modular, translucent storage compartments for improved organization and fast component selection.

- Kit contains Zenex™ non-conductive, light-weight padlocks with write-on labels for worker identification.
- Padlocks are keyed-different so that no unwanted key interchange occurs.

Set includes:

- (6) Zenex™ Padlocks
- (2) Circuit Breaker Padlocks
- Hasp
- Snap-On Hasp
- Adjustable Cable Lockout
- (2) Electrical Plug Lockouts
- (3) Gate Valve Covers
- (2) Single Pole Breaker Lockout Devices

- (2) Ball Valve Covers
- (4) "No Hole", 227 Volt Breaker Lockout Devices
- "No Hole", 480/600 Volt Breaker Lockout Device
- (2) Universal Multi-Pole Breaker Lockout Devices
- (2) Wall Switch Lockouts
- (12) "Do Not Operate" Tags

**Master
Lock**



F.O.B FACTORY
EACH

ITEM NO.	PRODUCT	EACH
3198 1458	Group Electrical and Valve Lockout Kits	\$395.95

Rotating Gate Valve Lockouts

Telescoping rotating design allows for easier installation in tight spaces.

- Each size rotates into itself and conveniently nests within the next larger size so they can be store in confined spaces.
- Surrounds valve operating handle to protect against accidental valve opening.
- Tough, light-weight, Zenex™ bodies withstand chemicals and temperatures between -50 °F and 350 °F.
- Write-on/erase-off labels are included. • Available individually or as a set of five.
- Up to four workers can apply their personal safety locks.



F.O.B FACTORY

ITEM NO.	PRODUCT	EACH
3198 04801	Fits 1" to 3" Diameter Valve Handles	\$17.45
3198 04811	Fits 2" to 5" Diameter Valve Handles	25.75
3198 04821	Fits 4" to 6-1/2" Diameter Valve Handles	32.95
3198 04831	Fits 6" to 10" Diameter Valve Handles	45.25
3198 04841	Fits 8" to 13" Diameter Valve Handles	79.05
3198 0485	Set of All 5 Gate Valve Lockouts	150.35

**Master
Lock**

MADE IN
USA

Universal Wall Switch Lockout

Locks out both toggle and Decora wall switches.

- Assures switch is locked on or off.
- Hinges open for unobstructed normal operation.

**Master
Lock**

MADE IN
USA



F.O.B FACTORY

ITEM NO.	PRODUCT	EACH
3198 04961	Universal Wall Switch Lockout	\$8.45

Rotating Electrical Plug Outlets

Unique rotating design allows for easier installation in confined spaces.

- Surrounds the electrical plug to protect against accidental reconnection.
- Each size rotates into itself for compact storage in safety tool boxes.
- Tough, light-weight Zenex™ bodies withstand chemicals and temperatures between -50 °F and 350 °F.
- High visibility write-on/erase-off labels are included.

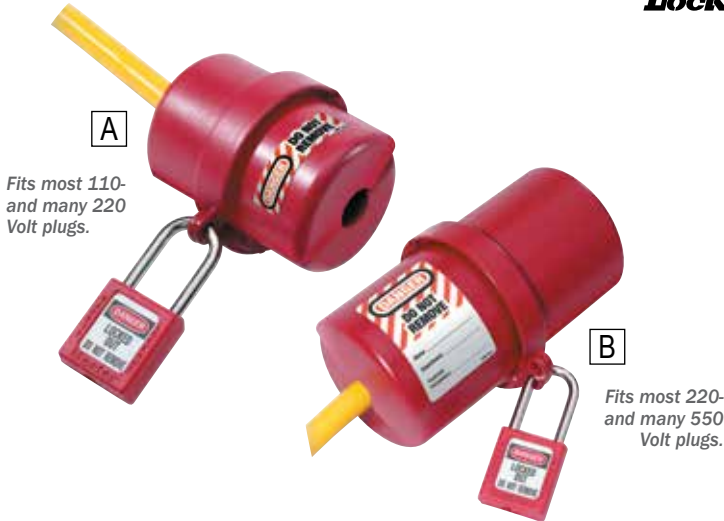

A
Fits most 110- and many 220 Volt plugs.

B
Fits most 220- and many 550 Volt plugs.

ITEM NO.	PRODUCT	EACH
3198 04871	A. 2-1/4" Dia. x 3-1/4" w/Cord Dia. Up to 3/4"	\$17.65
3198 04881	B. 3" Dia. x 6" w/Cord Dia. Up to 3/4"	19.25

Grip Tight™ Circuit Breaker Lockouts



Offers superior holding power with just a simple thumb turn and clamping handle.

- Two styles from which to choose: one for standard single and double breaker toggles, the other for tall and wide breaker toggles.
- Narrow profile permits side-by-side breaker lockout.
- Constructed of powder-coated steel and reinforced polymer to operate in harsh conditions.

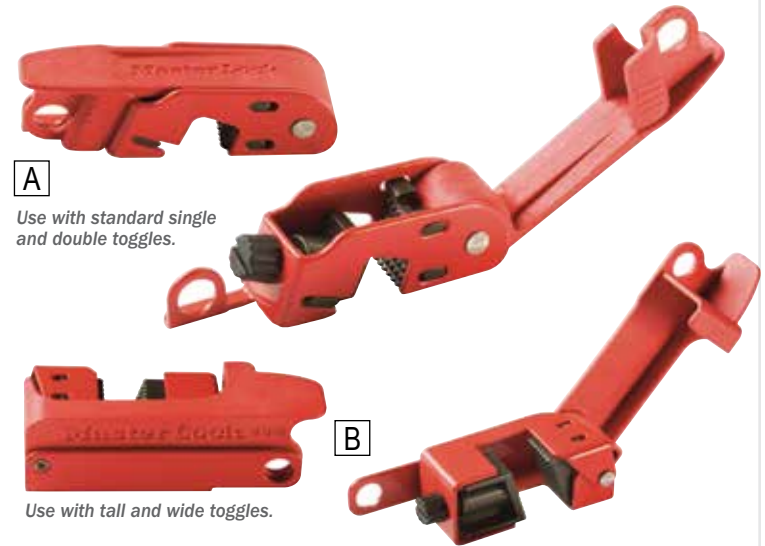

A
Use with standard single and double toggles.

B
Use with tall and wide toggles.

ITEM NO.	PRODUCT	EACH
3198 04931	A. For Standard Single and Double Toggles	\$7.75
3198 04911	B. For Tall and Wide Toggles	12.85

Self Laminating Photo ID Safety Tag

- Provides a visual representation of the authorized employee.
- 3/8 inch diameter brass grommet accepts all Master Lock and American Lock safety padlocks and hasps.
- Complies with OSHA lockout/tagout standard.
- Durable construction withstands over 50 pounds of force.
- Durable laminate overlay resists water, grease, extreme temperatures and common industrial chemicals.
- Customize with name, department and employee specific photo ID.
- Size: 3-1/5 inches x 5-4/5 inches.



▶ 6 TAGS PER BAG.

F.O.B FACTORY

ITEM NO.	PRODUCT	BAG
3198 48015	"Do Not Operate" Photo ID Safety Tags	\$37.05

Standard Group Lock Box

Standard ammo-box style is constructed of secure heavy-duty steel.

- Accommodates up to 12 workers, more with the use of lockout hasps.



ITEM NO.	PRODUCT	DIMENSIONS	EACH
3198 0498	Group Lock Box	9-1/4" x 3-3/4" x 6"	\$82.85

Latch Tight™ Group Lock Box

Latch-Tight™ feature eliminates all gaps to ensure keys can not be accessed until the very last lock is removed.

- Can be used as traditional bulk key storage through the key slot, or each of the 12 key holders can be labeled to determine which key opens which lockout point.
- Powder-coated red finish on heavy-duty steel box and stainless steel handle withstand harsh environments.
- Can be wall-mounted or used as a portable unit. • Accommodates up to 14 workers.



ITEM NO.	PRODUCT	DIMENSIONS	EACH
3198 0503	Group Lock Box	6-2/5" x 12-3/4"	\$88.95

Adjustable Cable Lockout



Six foot, pull-tight cable easily adjusts for a secure fit every time. Simply feed the cable through the points to be locked out and then back through the lockout body, then cinch it tight.

- Ideal for multiple circuit breaker panels and side-by-side gate valve lockouts.
- Multi-stranded 5/32 inch diameter steel cable is insulated with a clear vinyl coating.
- Lockout body withstands chemicals and performs well in extreme temperature conditions.
- Up to four workers can apply their personal safety locks.
- Write-on/erase-off labels are included for worker identification.

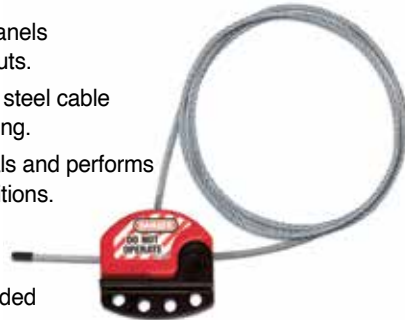

ITEM NO.	PRODUCT	EACH
3198 08061	Adjustable Cable Lockout w/6' Cable	\$36.85

"Do Not Operate" Lockout Hasp



Fits more lockout points than rivet-hinge labeled hasps.

- Snap-on, spring-loaded locking arm attaches with one hand to switches and controls.
- Inside jaw diameter: 1-3/4 inches x 2-1/8-inches.
- Aluminum and stainless steel construction.
- Write-on/erase-off labels are included for worker identification.

NOTE: Metal detectable version also available. CALL FOR MORE INFORMATION.



ITEM NO.	PRODUCT	DIMENSIONS	EACH
3198 04271	"Do Not Operate" Lockout Hasp	2.9" x 7"	\$19.25

Lockout Hasps



- Accommodates up to six locks.
- Choose from steel jaw with vinyl coated handle or spark resistant aluminum lockout hasp.

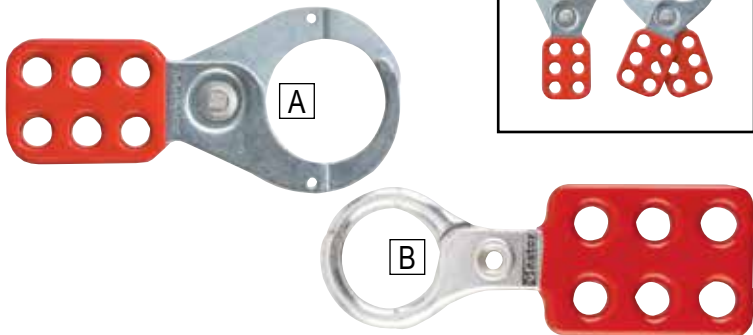

ITEM NO.	PRODUCT	EACH
3198 04201	A. 1" Steel Jaw w/Vinyl-Coated Handle Lockout Hasp	\$5.15
3198 04211	1-1/2" Steel Jaw w/Vinyl-Coated Handle Lockout Hasp	5.95
3198 0416	B. 1-1/2" Spark-Resistant Aluminum Lockout Hasp	5.15
3198 10801	1-3/4" Spark-Resistant Aluminum Lockout Hasp	8.85

Heavy-Duty Pry Proof Lockout Hasp



- Heavy-duty, pry-proof steel.
- Keeps equipment inoperative while repairs or adjustments are made.
- Control cannot be turned on until last worker's padlock is removed from hasp.

NOTE: Padlocks sold separately.

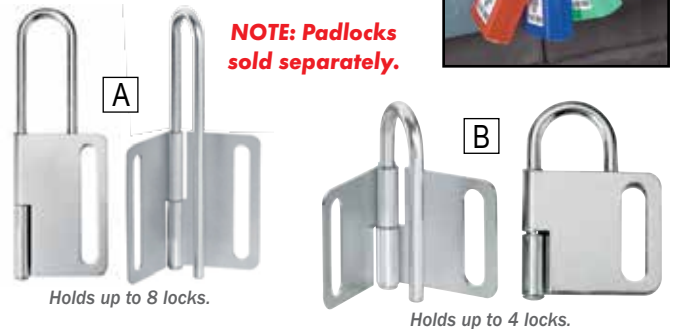

ITEM NO.	PRODUCT	DIMENSIONS	EACH
3198 04191	A. 3" Jaw	2-2/5" x 6.9"	\$10.95
3198 04361	B. 1" Jaw	2-2/5" x 3-1/4"	6.05

Padlock Lockout Stations

Polycarbonate material is heat- and impact-resistant.

- Lockable station cover prevents the loss of safety lockout padlocks.
- OSHA compliant key registration is included to record and track all key codes in your facility.
- Easy padlock and hasp storage and removal.
- Safety hasps and tags included.



4-Lock Station Includes:

- (4) Padlocks
- (2) Hasps
- (2) Twelve Packs of Tags

10-Lock Station Includes:

- (10) Padlocks
- (2) Hasps
- (2) Twelve Packs of Tags

ITEM NO.	PRODUCT	DIMENSIONS	EACH
3198 0417	A. 4-Lock Station	16" x 1-3/4" x 12-1/4"	\$183.95
3198 1483	B. 10-Lock Station	15-1/2" x 1-3/4" x 15-1/2"	\$336.05

Lockout Locks

- Thermoplastic body width: 1-1/2 inches.
- Complies with latest OSHA standards.
- Keyed differently. • Write-on labels included.
- Shackles: 1-1/2 inches.
- Available in seven colors, with safety identification on lock and key.
- Six pin cylinder, retaining key, dedicated safety key way and end user designation.



A. 3-Inch Locks

ITEM NO.	COLOR
3198 24111	Yellow
3198 66741	Blue
3198 34011	Orange
3198 04221	Green
3198 66731	Red
3198 34051	Black
3198 04341	Purple

EACH
\$20.95

B. 1-3/4-Inch Locks

ITEM NO.	COLOR
3198 14101	Yellow
3198 34101	Blue
3198 4100	Orange
3198 24101	Green
3198 04101	Red
3198 34121	Black
3198 41031	Purple

NOTE: Locks also available keyed alike. CALL FOR MORE INFORMATION.

EACH
\$16.35

ANSI RECOMMENDED COLOR USAGE FOR LOCK OUT/TAG OUT:
RED for Fire Quenching Materials (ie: Halon); **YELLOW** for Materials Inherently Hazardous (ie: Propane Gas); **BLUE** for Gases of Inherently Low Hazard (ie: Argon); **GREEN** for Liquids of Inherently Low Hazard (ie: Mill Water).

Aluminum Locks

The perfect choice for the industrial environment.



- Case hardened, triple plated, chrome shackles and cover plates with double ball locking mechanisms.
- Includes two keys. • Keyed differently. • Laser engravable.
- Solid aluminum bodies are ultra-light, corrosion- and spark-resistant.
- Anodized aluminum finish. • Body width: 1-1/2 inches.

NOTE: Locks also available keyed alike. CALL FOR MORE INFORMATION.



1-Inch Shackle

ITEM NO.	COLOR
3413 21071	Red

EACH
\$17.09

1-1/2-Inch Shackle

ITEM NO.	COLOR	ITEM NO.	COLOR
3413 43321	Green	3413 43351	Orange
3413 43301	Blue	3413 43331	Yellow
3413 43371	Purple	3413 43311	Brown
3413 43361	Red	3413 43341	Black

EACH
\$20.05

3-Inch Shackle

ITEM NO.	COLOR
3413 41921	Green
3413 41901	Blue
3413 41971	Purple
3413 41961	Red
3413 41951	Orange
3413 41931	Yellow
3413 41911	Brown
3413 41941	Black

EACH
\$21.05



Security Locks

Available in a variety of styles.

A. Combination Dial Lock

- Features stainless steel outer case with cold rolled steel inner case.
- Easy 3-number dialing with automatic scrambling feature.
- The 3/4" shackle has optional key hole on backside to override the combination. Key is sold separately. Please call to ensure key matches the lock keyway number.

B. Shackle Security Lock

- Keyed differently.
- Rustproof case hardened 7mm steel shackle with patented dual-locking levers.



NOTE: Locks also available keyed alike. CALL FOR MORE INFORMATION.

ITEM NO.	PRODUCT	EACH
3198 15251	A. Combination Lock, 3/4" Shackle	\$10.75
3198 00031	B. 3/4" Shackle Security Lock, Blue Bumper	11.85
3198 00131	1-1/2" Shackle Security Lock, Blue Bumper	16.85
3198 30031	C. 3/4" Shackle Security Lock, Red Bumper	13.85

XSORB Spill Clean-Up

- Non-toxic. • Absorbs oil and water based liquids.
- Leaves surface dry and slip free.

► SEE PAGE 579
For More Information



ITEM NO.	PRODUCT	F.O.B FACTORY BOX
6017 0025	25 lb Box	\$38.54

► 4 BOTTLES PER CASE.

ITEM NO.	PRODUCT	CASE
6017 0036	6 qt. Bottles	\$54.86



Anti-Slip Compound

Instant traction on slippery floors.

- Sprinkle over floors, walkways and work areas where water, grease or oil accumulate.
- Contains no sawdust, won't hold odors.
- Sweep or hose down at the end of each day.



NOTE:
Available in larger sizes.
CALL FOR DETAILS.

► 12 SHAKER CARTONS PER CASE.

ITEM NO.	PRODUCT	WEIGHT	CASE
7070 0010	Anti-Slip Compound	2-1/2 lb Carton	\$46.06



Biohazard Disinfecting Absorbent Kit

The safe, easy and economical spill clean up.

- Easily cleans up biohazard accidents such as vomit, blood and other body fluids while treating the spill with a powerful disinfecting agent.
- Each canister of Biofresh can absorb and disinfect up to one-half gallon and is specially engineered to instantly absorb, contain and disinfect on contact.
- Unlike other sorbents made from clay, D.E., or other decomposable materials, Biofresh will not break down and release its absorbed contents, contaminating the environment.

Kit Includes:

Canister of Biofresh
(2) Personal Protection Kits*
Step-By-Step Illustrated instructions

*Each Personal Protection Kit Includes:

Dust mask; pair non-latex protective gloves; small, disposable dustpan and brush set; red biohazard disposal bag and zip tie; (2) Disinfecting towelettes



ITEM NO.	PRODUCT	EACH
6017 00081	Biohazard Disinfecting Absorbent Kit	\$46.84
6017 10091	Replacement/Additional Biofresh Canister	6.52

ShurFoot Non-Slip Floor Compound

Absorbs grease, oil and blood.

- 50-pound box.



ITEM NO.	PRODUCT	BOX
3988 0051	ShurFoot Non-Slip Compound	\$43.95

Hazard Warning Tape

- Constructed of 6 mil conformable vinyl film with an acrylic adhesive system that will form a strong bond to most any clean, dry surface.
- Hi-visibility yellow/black PVC warning tape will quickly bring attention to any workplace hazard.
- Smooth, semi-matte surface for use on floors, walls, pipes and equipment.

ITEM NO.	PRODUCT	ROLL
5498 2110	2" x 108'	\$13.25

ITEM NO.	PRODUCT	ROLL
5498 2140	4" x 108'	\$25.24

▶ 24 ROLLS PER CASE.

▶ 12 ROLLS PER CASE.



True Grit Traction Tape

- Constructed from a thick PVC base layer impregnated with a 60-grit aluminum oxide compound to reduce slipping.
- Acrylic adhesive system will form a strong bond to most any clean, dry surface.
- For indoor or outdoor use – excellent wear resistance, weatherability and water resistance.
- Meets NFSI 101-A "High Traction" and OSHA standards.

ITEM NO.	PRODUCT	ROLL
5498 31021	2" x 60'	\$37.85

ITEM NO.	PRODUCT	ROLL
5498 31041	4" x 60'	\$75.55

▶ 6 ROLLS PER CASE.

▶ 3 ROLLS PER CASE.



NEED ASSISTANCE?

Our experienced customer service representatives are available to answer your questions, find the products you are looking for, check product availability, as well as take your order.

800-456-5624

Bloodborne Pathogen Response Kit

Rustproof plastic kit, with wall mount bracket for easy installation.

Kit Includes:

(2) Pair Medical Gloves	Gown, X-Large	Absorbent Towel
(2) Red Bio-hazard Bags	Face Mask	Shovel
Germicidal Towelette	Scraper	2-Ounce Solidifier
Antiseptic Wipes	Pair Shoe Covers	(2) Twist Ties

ITEM NO.	PRODUCT	EACH
3476 1033	Bloodborne Pathogen Kit	\$56.40



Body Fluid Spill Kit

- US Food Code 2-501.11 and OSHA Bloodborne Pathogen Standard 1910.1030 compliant.
- Two single-use kits included; 41 pieces in total.
- Size: 10-3/4 inches W x 11-1/2 inches H.
- Weight: 3 pounds 4 ounces.

Kit Includes:

Instructions: Written procedures with images and video instructions.

Disinfectant: 8-ounce bottle of PURELL® Foodservice Surface Sanitizer with trigger spray

Absorbent: Hospital-grade absorbent with deodorizer, gels up to 2 liters of body fluids

Tools: Coated handheld scraper, absorbent mops and closable dustpan w/floor seal

PPE: Waterproof shoe covers, gown w/sleeves, nitrile gloves, mask/eye shield and hairnet

Safety Data Sheets (SDS)



ITEM NO.	PRODUCT	EACH
3540 1041	Body Fluid Spill Kit	\$118.15

#25 First Aid Kit

- For up to 25 people. • ANSI Z308.1-2015 compliant. • Dimensions: 9-1/2 inches x 2-3/5 inches x 6-3/5 inches.
- White (plastic or steel) water-resistant box with handle and hanging bracket.

Kit Includes:

Adhesive Bandage, 4 inches x 2 inches	(4) Eye Pads w/Adhesive Strips
(32) Adhesive Bandages, 1 inch x 3 inches	Eye Wash, 1 ounce
(3) Fingertip Bandages	(10) Antiseptic Towelettes
(2) Knuckle Bandages	(10) Hand Sanitizer, 0.9 g
Triangular Bandage, 40 inches x 40 inches x 56 inches	(6) Sting Relief Wipes
(2) Roller Bandages, 2 inches	Cold Pack, 5 inches x 6 inches
Roller Bandage, 3 inches	Scissors
(10) Neomycin Antibiotic	Tweezer
(4) Gauze Pads, 3 inches x 3 inches	(2) Exam Gloves, Pair
(2) Trauma Pads, 5 inches x 9 inches	(3) Non-Aspirin Pain Reliever, 2/Pouch
(2) Adhesive Tape, 1/2 inch x 5 yards	CPR Filtershield
(10) Burn Cream, 1.0 g	First Aid Guide
Burn Dressing, 4 inches x 4 inches	



ITEM NO.	PRODUCT	EACH
3140 00091	#25 First Aid Kit, Class A	\$86.60
3140 00111	#25 First Aid Kit (Plastic Case)	43.62



ALL ITEMS ON ► PAGES 282-288 ARE NON-RETURNABLE MEDICAL PRODUCTS



#50 First Aid Kit

- For up to 50 people. • ANSI Z308.1-2015 compliant.
- White steel weatherproof box with handle and hanging bracket.
- Dimensions: 15-3/4 inches x 3 inches x 11 inches.

Kit Includes:

- (100) Adhesive Bandages, 1 inch x 3 inches
- (4) Adhesive Fingertip Bandages
- (2) Adhesive Bandages, X-Large
- (3) Knuckle Bandages
- (2) Adhesive Tape, 1/2 inch x 5 yards
- (12) Antimicrobial Towelettes
- (3) Conforming Bandages, 3 inches x 6 yards
- Elastic Bandage, 2 inches
- Triangular Bandage, 40 inches x 40 inches x 56 inches
- (12) Antibiotic Packages
- (10) Gauze Pads, Sterile, 2 inches x 2 inches
- (2) Gauze Pads, Sterile, 3 inches x 3 inches

Trauma Pad, Sterile, 5 inches x 9 inches

- (12) Burn Cream with Aloe, 1.0 g
- Burn Dressing, 4 inches x 4 inches
- (2) Instant Cold Packs, 5 inches x 6 inches
- (100) Adhesive Bandages, 1 inch x 3 inches
- (12) Sting Relief Wipes
- (2) Eye Pads
- Scissors
- Tweezers

- Eye Wash, 1 ounce
- (4) Pair Exam Gloves
- (6) Non-Aspirin Pain Reliever, 2/Pouch
- CPR Filtershield
- First Aid Guide
- Poison Control Directory



Honeywell
NORTH

ITEM NO.	PRODUCT	EACH
3140 00161	#50 First Aid Kit, Class A.	\$100.68

#100 First Aid Kit

- For up to 100 people. • ANSI Z308.1-2015 compliant.
- White steel weatherproof box with handle and hanging bracket.
- Dimensions: 15 inches x 4-3/4 inches x 10-1/2 inches.

Kit Includes:

- (6) Adhesive Bandages, 4 inches x 2 inches
- (100) Adhesive Bandages, 1 inch x 3 inches
- (40) Fingertip Bandages
- (40) Knuckle Bandages
- (2) Triangular Bandages, 40 inches x 40 inches x 56 inches
- (4) Roller Bandages, 2 inches
- (4) Roller Bandages, 4 inches
- Elastic Bandage, 2 inches x 4-1/2 yards
- (30) Neomycin Antibiotic
- (4) Blood Stopper Trauma Pads
- (10) Gauze Pads, 2 inches x 2 inches
- (25) Gauze Pads, 3 inches x 3 inches
- (2) Adhesive Tape, 1 inch x 5 yards
- (10) Non Adherent Pads, 2 inches x 3 inches

- Pump Burn Relief, 2 ounces
- (2) Burn Dressings, 4 inches x 4 inches
- (8) Eye Pads w/Adhesive Strips
- Eyewash, 4 ounces
- Pump Antiseptic, 2 ounces
- (10) Alcohol Prep Pads
- (10) Hand Sanitizer, 9 g
- (2) Cold Packs, 5 inches x 6 inches
- Scissors
- Tweezers

- (4) Pair Exam Gloves
- (50) Non-Aspirin Pain Reliever 2/Pouch
- Tourniquet
- Wire Splint
- CPR Filtershield
- First Aid Guide



Honeywell
NORTH

ITEM NO.	PRODUCT	EACH
3140 00171	#100 Bulk First Aid Kit, Class B.	\$237.23

Suture Strips

- Flexible, nonwoven material allows the strips to yield to the movement of skin.
- Water-resistant, skin-friendly adhesive.
- 3 strips per pack.
- Size: 1/4 inch x 3 inches.



▶ 50 PACKS PER BOX.

ITEM NO.	PRODUCT	BOX
6576 00085	Suture Strips Plus	\$119.50

Large Woven Adhesive Bandages

Honeywell
NORTH

- Woven cloth for comfort as well as stretch.
- Highly absorbent pad which won't stick to wounds.
- Rounded corners prevent snagging and roll-up.
 - 2 inches x 3 inches.



▶ 25 PER BOX - 24 BOXES PER CASE.

ITEM NO.	PRODUCT	BOX
0047 10205	Woven Bandages	\$9.74

Woven Fingertip Bandages

Honeywell
NORTH

- Provides a secure seal around the wound to help prevent contamination.
- Adhesive sticks in grease, oil and water.
- 3 inches x 1-1/2 inches.



▶ 50 PER BOX - 12 BOXES PER CASE.

ITEM NO.	PRODUCT	BOX
0047 64085	Fingertip Bandages.	\$15.46

Woven Knuckle Adhesive Bandages

Honeywell
NORTH

- Woven cloth for comfort and elasticity when added compression is required.
- Non-stick surface.
 - 2 inches x 3 inches.



▶ 100 PER BOX - 12 BOXES PER CASE.

ITEM NO.	PRODUCT	BOX
0047 64255	Knuckle Bandages	\$21.40

LATEX
FREE

Metal Detectable Bandages, Blue

Honeywell
NORTH

- Color: blue. • 1 inch x 3 inches.

LATEX
FREE



▶ 50 BANDAGES PER BOX.

ITEM NO.	PRODUCT	BOX
2644 00491	Bandages	\$2.95

Metal Detectable Bandages, Woven

Honeywell
NORTH

- Color: blue. • 1 inch x 3 inches.

LATEX
FREE



▶ 100 BANDAGES PER BOX.

ITEM NO.	PRODUCT	BOX
0047 64605	Bandages	\$15.97

Metal Detectable Knuckle Bandage

Honeywell
NORTH

- Uniquely designed to fit on injured knuckle.
- Color: blue.

LATEX
FREE



▶ 40 PER BOX.

ITEM NO.	PRODUCT	BOX
0047 3940	Knuckle Bandages	\$16.85

Natural Latex Finger Cots

- Can be used to protect fingers from contamination and infection during applications.
- Ideal for covering up bandages.
- Powder-free. • Length: 3/4 inch.
- 3 mil. • Color: white. • Rolled.
- Anti-static. • Disposable.



ITEM NO.	SIZE
3140 00845	Small, Size 1
3140 00855	Medium, Size 2
3140 00775	Large, Size 3
3140 00765	X-Large, Size 4

▶ 720 PER BAG.

BAG
\$42.91



Honeywell
NORTH

CAUTION: These products contain natural rubber latex which may cause allergic reactions in some individuals.



ALL ITEMS ON ► PAGES 282-288 ARE **NON-RETURNABLE MEDICAL PRODUCTS**



12-Ply, Non-Sterile Gauze Sponges



► 200 PER PACK

ITEM NO.	PRODUCT	PACK
0047 41225	2" x 2" (40 Packs/Case)	\$4.72
0047 41335	3" x 3" (20 Packs/Case)	11.32
0047 41445	4" x 4" (10 Packs/Case)	18.40

Plastic Finger Splints

- Help protect your finger from further injury.
- Can be cut with scissors for proper fit.
- 4 small, 4 medium and 4 large splints per box.



ITEM NO.	PRODUCT	BOX
3325 0031	Splints	\$18.40

Elastic Bandages



- For any body part.
- Non water-resistant.
- Non-adhesive.



► 10 ROLLS PER CASE.

ITEM NO.	PRODUCT	ROLL
0047 50201	2" x 4-1/2 yds.	\$1.71
0047 50301	3" x 4-1/2 yds.	2.03

Tubular Elastic Bandages

Stays in place without clips or tape.

- Provides 360° of compression and support with minimal danger of constriction.
- 100% cotton-knit tubular construction.



ITEM NO.	PRODUCT	EACH
3004 16521	3" x 11-yds.	\$27.95

Non-Sterile Gauze Rolls

- Elastic, non-latex bandages.
- Cotton gauze has soft texture that clings to itself.
- Holds dressings in place without slippage.
- For use in non- infection situations.



► 50 ROLLS PER CASE.

ITEM NO.	PRODUCT	ROLL
0047 18201	2" x 5-yds.	\$1.32

Gauze Bandages

- 2 inch x 4.1 yards.
- Elastic, non-latex bandages.



► 12 BANDAGES PER BAG - 8 BAGS PER CASE.

ITEM NO.	PRODUCT	BAG
3325 00621	Bandages	\$13.49

Flexicon® Non-Sterile Conforming Bandage

- Holds dressings securely without slipping.
- Molds to body contours to provide conforming properties
- Blue application guide helps to consistent wrapping



► 12 ROLLS PER PACK.

ITEM NO.	PRODUCT	PACK
3325 00645	2" x 4-1/10 yds.	\$8.75

Blood Stopper Compress



- Sterile gauze can be used as a trauma pad to apply pressure and help stop external bleeding.
- Dress surface wounds, burn and fractures to help prevent infection and improve healing.



ITEM NO.	PRODUCT	EACH
0047 19101	Compress	\$6.87

NO RETURN ALL ITEMS ON ► PAGES 282-288 ARE **NON-RETURNABLE MEDICAL PRODUCTS** **NO RETURN**

Bantex Tape

- Provides exceptional protection while still allowing flexibility, breathability and dexterity.
- Provides an improved grip for tools.
- Sticks only to itself.



ITEM NO.	PRODUCT	PACK
4536 30345	3/4" x 30-yds. (16 Rolls/Pack) . . .	\$36.74
4536 12305	1" x 30-yds. (12 Rolls/Pack).	35.59

Medi-Rip Bandages

- Adheres only to itself, NOT to skin or hair.
- Non-slip support and compression.
- Tear to desired length.

Honeywell
NORTH



► 96 ROLLS PER CASE.

ITEM NO.	PRODUCT	ROLL
3476 88901	2" x 5-yds.	\$5.27

Zonas Porous Tape

- Allows skin to breathe.
- Provides strong adhesive protection for immobilization of sprains.

Honeywell
NORTH



► 12 PER BOX - 12 BOXES PER CASE.

ITEM NO.	SIZE	BOX
0047 51045	1" x 10-yds.	\$60.46

Waterproof Adhesive Tape

Honeywell
NORTH



► 24 PER CASE.

ITEM NO.	PRODUCT	SIZE	EACH
0047 31461	1" Tape	1" x 10-yds.	\$4.94

SIGN UP FOR eDEALS

www.bunzlpd.com

Micropore Paper Tape

- Latex-free and hypo-allergenic.
- Holds well to damp skin for secure placement.
- Woven surgical tape. • 1 inch x 10 yards.



► 12 ROLLS PER BOX.

ITEM NO.	PRODUCT	BOX
3325 1092	Paper Tape	\$21.95

Paramedic Scissors

Honeywell
NORTH

- 7-1/4-inch utility shears.



► 12 PER CASE.

ITEM NO.	PRODUCT	EACH
0047 38741	7-1/4" Scissors.	\$8.27

Alcohol Wipes

Honeywell
NORTH

- 70% isopropyl.
- Convenient, individually packaged wipes in dispenser box.
- 1 inch x 2-1/2 inches.



► 50 PER BOX.

ITEM NO.	PRODUCT	BOX
0047 48185	Alcohol Wipes	\$8.32

Instant Cold Pack

- Temporary relief of pain and minor swelling.
- To use, locate the inner liquid bag and squeeze firmly to rupture bag, then shake contents to activate.

Honeywell
NORTH



► 54 PACKS PER CASE.

ITEM NO.	PRODUCT	EACH
0047 09051	6" x 9" Cold Pack	\$1.88



ALL ITEMS ON ► PAGES 282-288 ARE **NON-RETURNABLE** MEDICAL PRODUCTS



Burn Spray

- Relieves pain from minor burns.
- Contains antiseptic to help prevent infection from burns, minor cuts and abrasions.
- Water soluble and non-staining.
- 3-ounce aerosol can.



► 12 PER CASE.

ITEM NO.	PRODUCT	EACH
0047 10051	Burn Spray	\$12.73

Waterjel® Burn Dressing

- Sterile gel-soaked burn dressing.
- Emergency first aid for burns.
- 4 inches x 4 inches.



► 5 PER CASE.

ITEM NO.	PRODUCT	EACH
3476 10311	Burn Dressing	\$12.72

Anti-Itch Hydrocortisone Cream

- Provides temporary relief from itching, rashes, skin irritations, insect bites, poison oak, poison ivy and sumac.
- 1% solution formula.



► 20 PACKETS PER BOX - 20 BOXES PER CASE.

ITEM NO.	PRODUCT	BOX
0047 05085	Hydrocortisone Cream	\$7.38

Triple Antibiotic

- Antibiotic ointment.
- Helps prevent infection in minor cuts, scrapes and burns.



► 144 PACKETS PER BOX - 12 BOXES PER CASE.

ITEM NO.	PRODUCT	BOX
0047 12095	Triple Antibiotic	\$29.68

SHOP 24/7
bunzlpd.com

STAY CONNECTED WITH US:



Where you can find out what's on sale, find updated product information, reviews and pricing.





ALL ITEMS ON ► PAGES 282-288 ARE NON-RETURNABLE MEDICAL PRODUCTS



Cedaprin®

Honeywell
NORTH

- Contains: 200 mg Ibuprofen (pain reliever).
- Two tablets per pack.



► 50 PACKS PER BOX - 12 BOXES PER CASE.

ITEM NO.	PRODUCT	BOX
0047 61805	Cedaprin®	\$11.20



5-Grain Aspirin

Honeywell
NORTH

- For headaches, cold, flu, backaches and muscle aches.
- Two tablets per pack.



► 50 PACKS PER BOX.

ITEM NO.	PRODUCT	BOX
0047 03435	5-Grain Aspirin	\$6.95



Mygrex

- Contains: acetaminophen (pain reliever), phenylephrine hydrochloride (decongestant), caffeine (stimulant and pain reliever).
- Two tablets per pack.

► 150 PACKS PER BOX - 6 BOXES PER CASE.



ITEM NO.	PRODUCT	BOX
3377 4507	Mygrex™	\$88.19

Aypanal, Extra Strength

- Contains: Two tablets per pack.
- 500 mg acetaminophen.

Honeywell
NORTH



► 50 PACKS PER BOX - 12 BOXES PER CASE.

ITEM NO.	PRODUCT	BOX
0047 03415	X-Strength	\$10.76



Valihist Decongestant

Cold/Allergy Relief

- Contains: 325 mg Acetaminophen (pain reliever), 2 mg Chlorpheniramine Maleate (antihistamine), 5 mg Phenylephrine Hydrochloride (decongestant).
- Two tablets per pack.

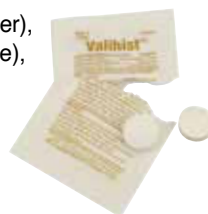

► 150 PACKS PER BOX - 6 BOXES PER CASE.

ITEM NO.	PRODUCT	BOX
3377 4363	Valihist	\$118.72

FREE SHIPPING *

FREE GROUND SHIPPING

when you place an order for \$500 or more from THIS BUYERS GUIDE!

*FREE SHIPPING does NOT include UPS Next Day Air, UPS 2nd Day or UPS 3rd Day Select. Certain items may not qualify. This offer is good only on orders shipped UPS Ground in the 48 contiguous states. Based on dimensional weight, we will determine the most efficient means of shipment, either UPS or LTL. Products may ship by truckline.

Faucet-Mounted Eye Wash

Converts any faucet into an emergency eye wash station without interfering with normal faucet operation.

- Aerated outlet heads deliver a soft, continuous flow of water.
- Float-off dust covers protect outlet heads.
- Adjustable heads permit full coverage and avoid splashing.
- Turn on water and pull knob to activate.
- 55/64 inch - 27 female thread inlet comes with 3 adapters (15/16-inch - 27, 13/16-inch -27 and 3/8-inch IPS) for installation on most commonly used faucets.
- Meets ANSI Z358.1- 2014 Classified Personal.



ITEM NO.	PRODUCT	EACH
B731 01021	Faucet-Mounted Eye Wash	\$124.60
B731 03071	Replacement Float-Off Dust Covers (Package of 2)	10.61

Counter/Wall-Mounted Eye Wash Drench Hose

Unit may be used as a fixed eye wash station or as a removable drench hose — meeting ANSI Z358.1- 2014.

- Both spray heads have a flip-top dust cover.
- Internal flow control and filter removes impurities from the water flow.
- Forged brass squeeze valve.
- Stainless steel lever handle has a locking clip to provide hands-free operation.
- 8-foot reinforced PVC hose has a working pressure of up to 300 PSI.
- Bracket with spring clips holds the unit on the wall.
- 3/8-inch NPT male swivel type inlet prevents backflow.
- ANSI-compliant sign included.



F.O.B FACTORY

ITEM NO.	PRODUCT	EACH
B731 02851	Wall-Mounted Eye Wash/Drench Hose	\$475.71
B731 02811	Counter-Mounted Eye Wash/Drench Hose	484.69

Wall-Mounted Eye Wash Station

Two spray heads deliver a soft flood of water for rinsing eyes.

- Both spray heads have a flip-top dust cover.
- Internal flow control and filter removes impurities from the water flow.
- Push handle activates IPS chrome-plated stay-open ball valve.
- Heavy-duty cast aluminum wall bracket with corrosion-resistant powder coated finish.
- 11-1/2 inch diameter bowl available in an orange ABS plastic or a stainless steel bowl.
- Supply 1/2-inch NPT female inlet; waste 1-1/4-inch NPT female outlet.
- Meets ANSI Eyewash Z358.1 - 2014 Standard.



F.O.B FACTORY

ITEM NO.	PRODUCT	EACH
B731 02031	A. Stainless Steel Bowl	\$381.19
B731 02041	B. Plastic Bowl.	299.87

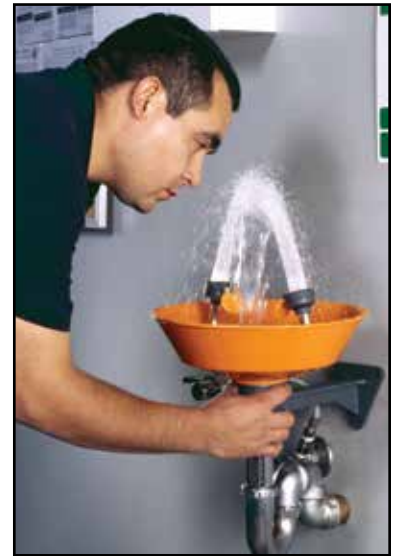

Sterile Eyesaline® Eyewash Station

- Can be mounted with screws.
- Two, 16-ounce bottles of sterile solution.
- Station is made of heavy-gauge polystyrene.
- Personal use bottles for flushing of eyes.



Each bottle has a large opening with a smooth flange for safe and easy use.

ITEM NO.	PRODUCT	EACH
3415 65011	Eyewash Station	\$72.39

Eyesaline® Eyewash

- Thimerosal free.
- 4-ounce bottle of isotonic buffered sterile solution.



▶ 24 PER CASE.

ITEM NO.	PRODUCT	EACH
3140 52001	Eyewash	\$6.43

WorkHorse® Safety Glasses with Premium Anti-Fog

- Anti-fog lenses resist fogging while wearing a facemask, or in cold or humid environments.
- After multiple washings, premium anti-fog coating retains effectiveness for the lifetime of the glasses.
- Meets ANSI Z87.1+, CE EN166 and CSA Z94.3. • 99.9% UV Protection.
- Scratch-resistant coating. • Metal-detectable hinge pins.



Blue, flexible temples are designed for the food processing industry and help provide secure fit.



**OUR PREMIUM ANTI-FOG COATING WILL NOT WEAR OR WASH OFF!
FOG-FREE GUARANTEED**



► 12 PER BOX - 25 BOXES PER CASE - 144 CASES PER PALLET.

ITEM NO.	PRODUCT	EACH
E542 09241	WorkHorse® Frameless Clear, Premium Anti-Fog	\$4.95
E542 09631	WorkHorse® Frameless Blue, Premium Anti-Fog	4.95

Genesis® Safety Eyewear

- Scratch-resistant lenses are available with Uvextreme® or HydroShield® anti-fog coating.
- Meets military VO ballistic test for impact.
- Lenses block 99.9% of UV rays.
- Meets both ANSI Z87.1 and CSA Z94.3 standards for impact protection.



Honeywell
UVEX

▶ 10 PER CASE.

ITEM NO.	PRODUCT	EACH
3415 85641	A. Blue Frame, Clear Lens w/Uvextreme®	\$14.63
3140 32001	B. Black Frame, Clear Lens w/HydroShield®	15.35

SecureFit™ 600 Series Safety Glasses

- Anti-scratch coating. • Soft nosepiece.
- Absorb 99.9% of UVA and UVB rays. • Meets ANSI Z87.1-2015 standards.
- Scotchgard™ anti-fog coating retains its effectiveness for at least 25 washings with water.



3M

▶ 20 PER CASE.

ITEM NO.	PRODUCT	EACH
6655 37821	Black Frame, Clear Lens	\$15.27

SecureFit™ 200 Series Safety Glasses

- Blue temples and blue lenses. • Absorb 99.9% of UVA and UVB rays.
- Scotchgard™ anti-fog coating retains its effectiveness for at least 25 washings with water.
- Meets ANSI Z87.1-2015 standards.



3M

▶ 20 PER CASE.

ITEM NO.	PRODUCT	EACH
6655 48571	Blue Frame, Blue Lens	\$6.88

Ironwear Iron-Fog Safety Glasses

- Premium grade Anti-Fog protection that lasts over 6 months based on application.
- Curved, scratch resistant lenses with nylon frame offers full side protection.
- Greater than 99% protection from UVA and UVB rays.
- Meets ANSI Z87+ and CE "N" standards for EN166:2001.



▶ 12 PER CASE.

ITEM NO.	PRODUCT	EACH
G904 01201	Blue Frame, Clear Lens	\$6.25



WARNING: Some products in this catalog may expose you to chemicals including DEHP Di (2-ethylhexyl) phthalate or BPA (Bisphenol A) which are known to the State of California to cause cancer or birth defects or other reproductive harm. For more information, visit www.P65Warnings.ca.gov.



! WARNING on 3M/AOSafety™ Eye Protection: These eye and face protection products help provide limited eye and face protection. Misuse or failure to follow warnings and instructions may result in serious potential injury, including blindness or death. For proper use, selection and applications against flying particles, optical radiation and/or splash see supervisor, read User Instructions and warnings on the package or call 3M OH&ESD Technical Service in the USA at 1-800-243-4630. In Canada, call 1-800-267-4414.

WorkHorse® Safety Glasses with Standard Anti-Fog

- Scratch-resistant coating.
- Metal-detectable hinge pins.
- 99.9% UV Protection.
- Meets ANSI Z87.1+, CE EN166 and CSA Z94.3 standards.

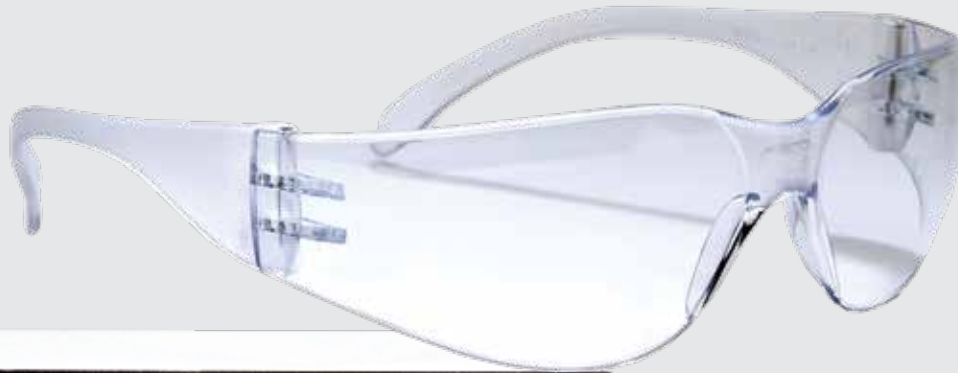

STANDARD ANTI-FOG LENSES

RESIST FOGGING WHILE WEARING A FACEMASK OR IN COLD OR HUMID ENVIRONMENTS



► 12 PER BOX - 25 BOXES PER CASE - 144 CASES PER PALLET.

ITEM NO.	PRODUCT	EACH
E542 09211	WorkHorse® Frameless Clear, Standard Anti-Fog	\$2.95
E542 09221	WorkHorse® Frameless Blue, Standard Anti-Fog	2.95

Tomahawk® Safety Glasses

- Wrap around design with adjustable, ratchet action temples and a one-piece polycarbonate lens with side shields.
- Lenses offer 99.9% ultraviolet protection with Duramass® scratch-resistant coating.
- Meets ANSI Z87+ standards.



▶ 12 PER CASE.

ITEM NO.	PRODUCT	EACH
3420 64071	Black Frame, Clear Anti-Fog Lens	\$4.95

Astrospec 3000® Safety Eyewear

- Adjustable lens inclination and temple length.
- Ultra-dura® anti-scratch and Uvextreme® anti-fog coatings.
- Meets ANSI Z87.1 and CSA Z94.3 standards.



▶ 10 PER CASE.

ITEM NO.	PRODUCT	EACH
3179 29271	Blue Frame, Clear Lens	\$14.11

Zenon Z-12 Safety Glasses

- Thin, flexible temples.
- Anti-fog lenses.
- Meets ANSI Z-87+ standard.
- Light-weight, rimless design.



▶ 12 PER CASE.

ITEM NO.	PRODUCT	EACH
6292 09211	Anti-Fog, Clear Temples w/Clear Lens	\$3.85

Adversary™ Safety Glasses

- Soft nose piece, rubber temples with lanyard.
- Scratch-resistant and anti-fog coated polycarbonate lenses.
- Exceeds ANSI Z87.1+ High-Impact Requirements.



▶ 12 PER CASE.

ITEM NO.	PRODUCT	EACH
6292 80201	Clear Lens, Anti-Fog	\$6.45



WARNING: Some products in this catalog may expose you to chemicals including DEHP Di (2-ethylhexyl) phthalate or BPA (Bisphenol A) which are known to the State of California to cause cancer or birth defects or other reproductive harm. For more information, visit www.P65Warnings.ca.gov.



! WARNING on 3M/AOSafety™ Eye Protection: These eye and face protection products help provide limited eye and face protection. Misuse or failure to follow warnings and instructions may result in serious potential injury, including blindness or death. For proper use, selection and applications against flying particles, optical radiation and/or splash see supervisor, read User Instructions and warnings on the package or call 3M OH&ESD Technical Service in the USA at 1-800-243-4630. In Canada, call 1-800-267-4414.

WorkHorse® Safety Glasses with No Anti-Fog

- Scratch-resistant coating. • Metal-detectable hinge pins.
- 99.9% UV Protection. • Meets ANSI Z87.1+, CE EN166 and CSA Z94.3 standards.



▶ 12 PER BOX - 25 BOXES PER CASE - 144 CASES PER PALLET.

ITEM NO.	PRODUCT	EACH
E542 09231	WorkHorse® Frameless Clear, No Anti-Fog	\$1.95
E542 09201	WorkHorse® Frameless Blue, No Anti-Fog	1.95

Millennia Sport™ Safety Glasses

- Light-weight nylon frame style offers superior side protection.
- Meets ANSI Z87.1 and CSA Z94.3 standards.
- Scratch-resistant hard coat for longer lens life.
- Adjustable break-away FlexiCord™.

▶ 10 PER CASE.

ITEM NO.	PRODUCT	EACH
3415 03501	Black Frame, Clear Lens	\$12.95



Honeywell
UVEX

Pyramex Integra Safety Glasses

- 100% polycarbonate scratch-resistant lenses.
- Adjustable temples ensure reliable performance.
- Provides 99% protection from harmful UV-A and UV-B rays.
- Exceeds ANSI Z87.1-2003 high-impact requirements.

▶ 12 PER CASE.

ITEM NO.	PRODUCT	EACH
E173 04101	Clear Lens	\$3.05



Storm® Safety Glasses

- Ratchet-action temples and non-slip head-grips provide customized fit for any size.
- Lenses offer 99.9% ultraviolet protection along with Duramass® scratch-resistant coating.
- Indoor/Outdoor lenses have a mirrored coating to reduce glare.
- Meets ANSI Z87.1+ standard.

▶ 12 PER CASE.

ITEM NO.	PRODUCT	EACH
3420 64051	A. Black Frame, Clear Lens	\$6.45
3314 64061	B. Black Frame, Indoor/Outdoor Lens	6.45



MCR
SAFETY

Smith & Wesson Magnum™ Safety Glasses

- Manufactured of shatter-resistant polycarbonate lenses.
- Exceeds all ANSI Z87.1 performance standards.
- Lenses provide maximum protection from ultraviolet rays.



▶ 12 PER CASE.

ITEM NO.	PRODUCT	EACH
3512 59771	Black Frame, Clear Lens	\$12.82

Economy Safety Glasses

- Thin, flexible temples provide secure fit.
- Available with scratch-resistant coating.
- Saddle nose bridge design fits most wearers.
- Meets ANSI Z87.1+ standards.



▶ 12 PER CASE.

ITEM NO.	PRODUCT	EACH
6292 09131	A. Small, Clear Scratch-Resistant Lens, Clear Temple	\$2.25
6292 05841	B. Small, Clear Scratch-Resistant Lens, Black Temple	2.25
6292 09051	Regular, Clear Uncoated Lens, Black Temple	2.45

Rendezvous Safety Glasses

- Provides 99% protection from harmful UV-A and UV-B rays.
- 100% polycarbonate, scratch-resistant lenses. • Temples adjust to four different lengths.
- Rubber, adjustable nose pad. • Exceeds ANSI Z87.1-2003 requirements.



▶ 12 PER CASE.

ITEM NO.	PRODUCT	EACH
E173 28101	Clear Lens	\$5.15

3M™ Tour-Guard™ V Safety Glasses

- Impact-resistant Duralite® polycarbonate construction.
- Meets the requirements of ANSI Z87.1-2010 and CSA Z94.3-2007.
- Fits over most prescription glasses. • 99.9% UV protection.



▶ 100 PER CASE.

ITEM NO.	PRODUCT	EACH
6655 31521	Tour-Guard™ V, Clear Lens	\$3.80

The Scout Safety Glasses

- Polycarbonate unilens. • Hard-coat lens to resist scratching. • Fits over most prescription glasses.
- Vented temples for reduced fogging. • Meets ANSI Z87.1 standards.



▶ 12 PER CASE.

ITEM NO.	PRODUCT	EACH
6292 19001	Clear Lens	\$2.35



WARNING: Some products in this catalog may expose you to chemicals including DEHP Di (2-ethylhexyl) phthalate or BPA (Bisphenol A) which are known to the State of California to cause cancer or birth defects or other reproductive harm. For more information, visit www.P65Warnings.ca.gov.



! WARNING on 3M/AOSafety™ Eye Protection: These eye and face protection products help provide limited eye and face protection. Misuse or failure to follow warnings and instructions may result in serious potential injury, including blindness or death. For proper use, selection and applications against flying particles, optical radiation and/or splash see supervisor, read User Instructions and warnings on the package or call 3M OH&ESD Technical Service in the USA at 1-800-243-4630. In Canada, call 1-800-267-4414.

Eva® Pink Frame Scratch Resistant Safety Glasses

Show your support for breast cancer awareness.

- Smaller and narrower frame design with pink accents.
- Narrow saddle nose bridge design.
- Thin, flexible temples provide secure fit without pinching.
- Meets ANSI Z87.1+ standard.

▶ 12 PER CASE

ITEM NO.	PRODUCT	EACH
6292 09001	Regular, Clear, Scratch-Resistant Lens	\$6.35



▶ SEE PAGE 7
For Pink Products

Pink Eyewear Strap

- Mono slide adjusts for the perfect fit.
- Rubberized sleeves tightly hold eyewear.
- Strap length: 22 inches.

▶ SEE PAGE 7
For Pink Products



ERB
Safety Products for LIFE.



▶ 12 PER CASE

ITEM NO.	PRODUCT	EACH
3425 53231	Pink Eyewear Strap	\$2.95

UVEX Clear® Plus

An easy solution for cleaning your eyewear.

- Pre-moistened disposable lens cleaning towelettes.
- Ideal for plastic, glass or polycarbonate eyewear.

▶ 100 FOIL PACKED TOWELETTES PER BOX.

ITEM NO.	PRODUCT	BOX
3415 82735	Towelettes	\$23.48



Honeywell
UVEX

MADE IN
USA

MotoSolutions FogTech Anti-Fog Wipes

Prevents fogging of safety glasses, goggles and face shields.

- Works great on eyewear with or without a factory applied coating.
- Ideal when conditions for fogging are severe.
- Can be re-applied, as needed, to restore maximum effectiveness.

▶ 100 PER BOX.

ITEM NO.	PRODUCT	BOX
B754 0093	Anti-Fog Wipes	\$80.24



Fog Eliminator Wipes

- Formulated to effectively protect lenses from all types of fogging caused by cold, high humidity or sudden temperature changes.
- 8-hour fog protection – anti-fog properties can last up to 1 week undisturbed.
- Safe for all surfaces, including polycarbonate and glass and provide multiple uses.
- Individually foil wrapped.

▶ 100 PER BOX.

ITEM NO.	PRODUCT	BOX
3415 82775	Fog Eliminator Wipes	\$137.49



Honeywell
UVEX

MADE IN
USA

Snakeskin® Safety Cord for Glasses

- Adjustable cord wraps around the back of the wearer's neck, slides over the earpieces, and grips them tightly.
- Color: black.

▶ 12 PER BOX.

NOTE: Safety glasses, sold separately.

ITEM NO.	PRODUCT	EACH
3420 02151	Safety Cord	\$4.29



Acrylic Safety Glasses Dispenser

- Clear acrylic construction for easy recognition of contents.
- Safety glasses dispenser holds 12 to 24 pair, depending on style.

ITEM NO.	PRODUCT	F.O.B FACTORY EACH
3364 2825	Dispenser	\$92.99



NUVO™ Magnifying Reader Safety Glasses

Available in three different diopters for workers engaged in small detail work.

- Cushioned brow bar.
- Integral side shields.
- Clear anti-fog lens.
- Soft nosepiece and temple tips.
- Impact-resistant lenses absorb 99.9% UV.
- Meets ANSI Z87.1-2003 and CSA Z94.3 standards.



ITEM NO.	PRODUCT
6655 63881	Clear Lens, Gray Frame, +1.50 Diopter
6655 74221	Clear Lens, Gray Frame, +2.00 Diopter
6655 74231	Clear Lens, Gray Frame, +2.50 Diopter

▶ 20 PER BOX.

EACH
\$22.81

MAG Readers

- 30 mm bifocal lens.
- Hard coated lenses. • Exceeds ANSI Z87.1+ requirements.
- Durable nylon frame with extra wide bridge pads and soft temple pads.



ITEM NO.	PRODUCT
6292 51101	Clear Lens, Black Temples, +1.00 Diopter
6292 51151	Clear Lens, Black Temples, +1.50 Diopter
6292 51201	Clear Lens, Black Temples, +2.00 Diopter
6292 52251	Clear Lens, Black Temples, +2.50 Diopter
6292 51301	Clear Lens, Black Temples, +3.00 Diopter

▶ 12 PER BOX.

EACH
\$8.48

OX™ 2000 Safety Glasses

Fits over most prescription lenses.

- Meets the requirements of ANSI Z87.1-2003 and CSA Z94.3-2007.
- Duralite™ polycarbonate lens absorbs 99.9% UV.
- DX™ anti-fog hard coat protects lens from fog, scratching and most chemicals.
- Durable nylon frame with extra wide bridge pads and soft temple pads.
- Adjustable length Secure Grip™ temple fits any size face and holds eyewear securely in place.



▶ 20 PER BOX.

ITEM NO.	PRODUCT	EACH
6655 74651	Black Frame, Clear Lens	\$6.91



Soft PVC, Fog-Free Goggles

Fog-free impact goggles provide protection against many processing and splash hazards.

- Fits over most prescription glasses.
- UV-AF anti-fog lens.
- Meets ANSI Z87+ standard.



▶ 50 PER CASE.

ITEM NO.	PRODUCT	EACH
3314 49161	Fog-Free PVC Goggle, Clear Lens	\$7.52



Visorgog®

Fog-free vents prevent lenses from fogging up.

- A goggle and head visor combined into one product for superior protection.
- Made of impact resistant polycarbonate. • Opaque visor top blocks overhead glare.
- Clear lenses protects eyes from harmful liquids and particles.



▶ 72 PER CASE.

ITEM NO.	PRODUCT	EACH
0186 48621	Green Visorgog®, Clear Lens	\$12.13



WARNING: Some products in this catalog may expose you to chemicals including DEHP Di (2-ethylhexyl) phthalate or BPA (Bisphenol A) which are known to the State of California to cause cancer or birth defects or other reproductive harm. For more information, visit www.P65Warnings.ca.gov.



! WARNING on 3M/AOSafety™ Eye Protection: These eye and face protection products help provide limited eye and face protection. Misuse or failure to follow warnings and instructions may result in serious potential injury, including blindness or death. For proper use, selection and applications against flying particles, optical radiation and/or splash see supervisor, read User Instructions and warnings on the package or call 3M OH&ESD Technical Service in the USA at 1-800-243-4630. In Canada, call 1-800-267-4414.

GoggleGear 500 Series

- Low-profile design with adjustable strap and indirect ventilation.
- 3M™ Scotchgard™ Anti-Fog Coating lasts longer than traditional anti-fog coatings.
- Coating retains its effectiveness for at least 25 washings with water.
- The coating withstands disinfection with diluted bleach soaking or alcohol wipes without losing anti-fog performance.
- Polycarbonate lens absorbs 99.9% of UV rays.
- Meets ANSI Z87.1-2015 and CSA Z94.3 standards.



▶ 10 PER CASE.

ITEM NO.	PRODUCT	EACH
6655 49671	Goggle Gear 500	\$25.63

Stealth® Goggles

- Easiest lens replacement system available.
- Toric lens for superior optics and peripheral vision.
- Quick, adjustable headband with a futuristic, low-profile design that protects eyes from chemical splashes and unexpected impacts.
- Meets ANSI Z87.1-2015 and CSA Z94.3 standards.



Anti-Fog coating and indirect ventilation system minimize fogging.



▶ 50 PER CASE.

ITEM NO.	PRODUCT	EACH
3140 39601	Gray Frame, Clear HydroShield® AF Lens	\$24.03

▶ 10 PER BOX - 10 BOXES PER CASE.

ITEM NO.	PRODUCT	EACH
3140 69171	Replacement Lens, Clear, HydroShield®	\$9.47

Bouton 5300 Contempo Goggles

Indirect ventilation, channels across top and bottom for air flow.

- Full polycarbonate frame, anti-scratch lenses, with elastic braid strap with adjustable buckle.
- Frame splits at nose for comfort fit.
- Pliable one-piece frame.
- Side recesses to accept eyewear temples.
- Meets ANSI Z87.1+ standards.



▶ 50 PER CASE.

ITEM NO.	PRODUCT	EACH
6292 53011	Contempo Goggles w/Clear Anti-Scratch Lens	\$12.03

Bouton Basic™ Goggles

- Pliable one-piece frame.
- Direct side ventilation.
- Fits over most prescription eyewear.
- Polycarbonate lens with anti-scratch coating.
- Meets ANSI Z87.1+ requirements.



▶ 144 PER CASE.

ITEM NO.	PRODUCT	EACH
6292 43001	Basic Goggle, Clear Lens	\$2.65

Flex Seal® Goggles

Soft seal adds protection in harsh chemical environments and stays supple in extreme temperatures.

- Silicone construction provides all-day comfort, superior fit and climate adaptability.
- Pivoting clip enables quick removal of headband from goggle.
- HydroShield® anti-fog coated.
- Fits over many prescription frames.
- Adjustable neoprene headband.
- Meets ANSI Z87.1+-2015 and CSA Z94.3 standards.





▶ 10 PER CASE.

ITEM NO.	PRODUCT	EACH
3140 00511	Gray Frame w/HydroShield® Anti-Fog Clear Lens	\$22.20



WARNING: Some products in this catalog may expose you to chemicals including DEHP Di (2-ethylhexyl) phthalate or BPA (Bisphenol A) which are known to the State of California to cause cancer or birth defects or other reproductive harm. For more information, visit www.P65Warnings.ca.gov.



! WARNING on 3M/AOSafety™ Eye Protection: These eye and face protection products help provide limited eye and face protection. Misuse or failure to follow warnings and instructions may result in serious potential injury, including blindness or death. For proper use, selection and applications against flying particles, optical radiation and/or splash see supervisor, read User Instructions and warnings on the package or call 3M OH&ESD Technical Service in the USA at 1-800-243-4630. In Canada, call 1-800-267-4414.

Light-Duty Face Shield*

Anti-fog plastic shield covers your eyes, nose and mouth.

- Anti-fog coating on interior of face shield.
- Lightweight and flexible.
- Protects against splashes and droplets.
- Elastic band ensures one-size-fits-all.
- Fits over prescription glasses.
- Dimensions: 13 inches W x 9 inches L.



Peel-off, scratch-resistant coating protects shield prior to use.



Face Shield can be worn under or over hard hat or bump cap.



▶ 200 PER CASE.

ITEM NO.	PRODUCT	EACH
E542 09941	Light-Duty Face Shield	\$4.95

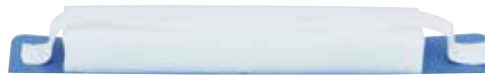

Sponge padding on forehead area for added comfort.

* Not N95 rated — strictly for nuisance and droplet protection. General use masks, not intended for use by health care professionals. Not impact rated.

V90 Shield

The ultimate eye and face protection.

- Features Monogoggle XTR with detachable full face protection.
- Curved face shield conforms to shape of face offering better protection.
- Polycarbonate shield for added protection.
- Fits over most prescription eyewear.
- Chemical and impact protector.
- Meets ANSI Z87.1+ impact standards.



JACKSON
SAFETY

ITEM NO.	PRODUCT	EACH
C241 20111	V90 Shield	\$29.13

Face Shield

- Full-face protection from flying objects, abrasive particles and chemical splashes.
- Swivel visor up when not in use.

NOTE: Replaceable visors sold separately.



ITEM NO.	PRODUCT	EACH
3314 41201	Face Shield w/Headgear	\$13.26
3420 10721	Replacement Face Shield Visor, 8" x 15-1/2"	3.19

QB2HYG® Quiet Band

NRR-25

- Patented band design prevents ear pods from touching dirty or contaminated surfaces.
- Light-weight and portable — designed especially for environments with intermittent noise hazards.
- Soft, replaceable ear pods for supra-aural fit.
- Pods rest inside the ear canal opening.



Honeywell
HOWARD
LEIGHT

▶ 100 PER CASE.

ITEM NO.	PRODUCT	EACH
3140 99161	QB2HYG®	\$6.68

▶ 200 PER CASE.

ITEM NO.	PRODUCT	PAIR
3140 99171	Replacement Pods	\$4.94



SIGN UP FOR OUR eDEALS

Get exclusive offers not found anywhere else!

eDEAL SIGN-UP FORM AVAILABLE ON OUR WEBSITE.

www.bunzlpd.com

Acrylic Earplug Dispenser

Put safety items at your employees' fingertips.

- Clear acrylic construction for easy recognition of contents.
- Dispenser holds 200 pairs.



NOTE: Earplugs sold separately.

ITEM NO.	PRODUCT	DIMENSIONS	EACH
3364 2827	Dispenser	11-3/4" x 11" x 7-3/4"	\$117.59

Rack'Em Earplug Rack

For use with foam earplug dispenser boxes.

- Holds 200-count foam ear plug dispenser box.
- Mount racks on wall with screws or foam tape.
- Velcro™ Grab'Em™ straps fastens box to rack.
- Prevents ear plugs from falling on floor.



NOTE: Earplugs sold separately.



ITEM NO.	PRODUCT	DIMENSIONS	EACH
3446 40011	Earplug Rack	11-3/4" x 10-1/2" x 11-1/2"	\$69.84

FitCheck Solo

Test the attenuation of any type of earplugs or insert hearing protector with FitCheck Solo.

- Provides test results that are representative of ANSI S12.6-2016, which is the 'gold standard' for hearing protector attenuation measurements.
- Test from 3 to 7 frequencies to generate a Personal Attenuation Report (PAR) – an attenuation calculation that can be compared to the earplug's NRR.
- Simply plug the FitCheck Solo headphone's 3.5 mm plug into any PC and run the FitCheck Solo application.
- Convenient file storage options and reporting capabilities.
- Software is easy to use and is compatible with Windows XP 7/8/10.
- Based on NIOSH WellFit program.
- FitCheck Solo is the ONLY Field Attenuation Estimation System (FAES) that does not require external hardware – no communication errors, power supplies or cabling requirements.



TRAINING AND FIT TESTING TAKES LESS THAN 10 MINUTES.

CALL 800-456-5624 FOR MORE INFORMATION





WorkHorse® Tapered Disposable Earplugs

NRR-33, highest NRR available in an earplug.

- Tapered shape designed to fit most ear sizes.
- Constructed of expandable foam for a comfortable seal.
- Blue cords and orange earplugs are highly visible.
- Individually poly-bagged.



▶ 100 PAIR PER DISPENSER BOX - 10 BOXES PER CASE - 16 CASES PER PALLET.

ITEM NO.	PRODUCT	BOX
E542 09455	WorkHorse® Tapered Disposable Earplugs	\$29.95

3M™ E-A-R™ TaperFit™ 2 Earplugs

NRR-32 dB*

- Soft, smooth, self-adjusting foam.
- Poly-bagged.

▶ 200 PAIR PER DISPENSER BOX - 10 BOXES PER CASE.

ITEM NO.	PRODUCT	BOX
6655 64455	TaperFit™ 2 w/Cord	\$102.33

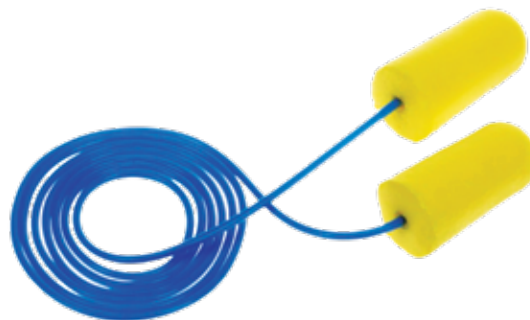
**3M****3M™ E-A-Rsoft™ Yellow Neon Blasts™ Earplugs**

NRR-33 dB*

- Individually poly-bagged.

▶ 200 PAIR PER DISPENSER BOX - 10 BOXES PER CASE.

ITEM NO.	PRODUCT	BOX
6655 63975	Neon Blasts™ w/Cord	\$98.15

**3M****SparkPlugs® Earplugs**

NRR-33

- 100% PVC-Free®.

▶ 100 PAIR PER DISPENSER BOX - 20 BOXES PER CASE.

ITEM NO.	PRODUCT	BOX
2222 28235	SparkPlugs® w/Cord	\$41.95

**MOLDEX****Pura-Fit® Earplugs**

NRR-33

- 100% PVC-Free®.
- Smooth outer finish won't irritate ears.

▶ 100 PAIR PER DISPENSER BOX - 20 BOXES PER CASE.

ITEM NO.	PRODUCT	BOX
2222 31035	Pura-Fit® w/Cord	\$42.05

**MOLDEX**

! WARNING on 3M/EAR™ Hearing Protection: These hearing protectors help reduce exposure to hazardous noise and other loud sounds. Misuse or failure to wear hearing protectors at all times you are exposed to noise may result in hearing loss or injury. For proper use, see supervisor, User Instructions, or call 3M in the USA at 1-800-243-4630. In Canada, call Technical Service at 1-800-267-4414. If there is any drainage from your ear or you have an ear infection, consult with your physician before wearing ear plugs. Failure to do so may result in hearing loss or injury. * Research suggests that many users will receive less noise reduction than indicated by the NRR due to variation in earplug fit and wearing time. It is recommended that the NRR be reduced by 50% for estimating the average amount of noise reduction provided.



WorkHorse® Bell-Shaped Disposable Earplugs

NRR-32

- Bell shape follows the natural contours of the ear canal.
- Constructed of expandable foam for a comfortable seal.
- Blue cords and orange earplugs are highly visible.
- Individually poly-bagged.

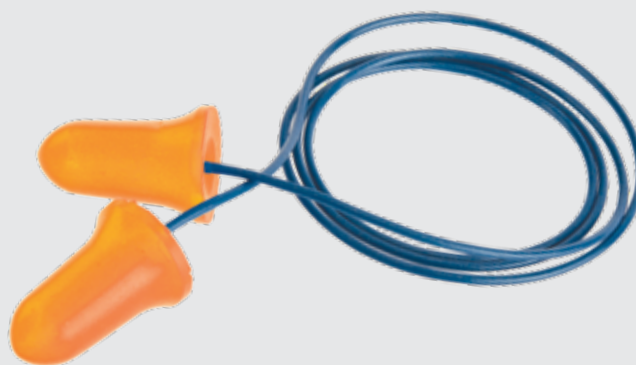

► 100 PAIR PER DISPENSER BOX - 10 BOXES PER CASE - 16 CASES PER PALLET.

ITEM NO.	PRODUCT	BOX
E542 09475	WorkHorse® Bell-Shaped Disposable Earplugs	\$29.95

MAXIMUM Foam Earplugs

NRR-33

- Polyurethane foam enhances comfort, especially for long-term wear.
- Smooth, soil-resistant closed-cell foam skin prevents dirt build-up.
- Individually poly-bagged.

▶ 100 PAIR PER DISPENSER BOX - 10 BOXES PER CASE.

ITEM NO.	PRODUCT	BOX
3140 88025	MAXIMUM Regular Foam w/Cord	\$45.13

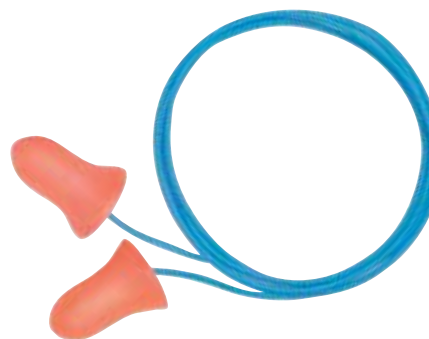

Honeywell
HOWARD
LEIGHT

MAXIMUM LITE Foam Earplugs

NRR-30

- Contoured T-shape for easier insertion and removal.
- Individually poly-bagged.

▶ 200 PAIR W/O CORD PER DISPENSER BOX - 10 BOXES PER CASE.

▶ 100 PAIR W/CORD PER DISPENSER BOX - 10 BOXES PER CASE.

ITEM NO.	PRODUCT	BOX
3140 99235	MAXIMUM LITE Foam w/o Cord	\$37.53
3140 01505	MAXIMUM LITE Foam w/Cord	44.27

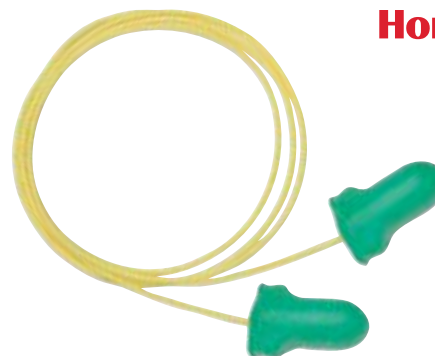

Honeywell
HOWARD
LEIGHT

Laser Lite® Earplugs

NRR-32

- Non-irritating and non-allergenic.
- Individually poly-bagged.

▶ 100 PAIR PER DISPENSER BOX - 10 BOXES PER CASE.

ITEM NO.	PRODUCT	BOX
3140 55305	Laser Light® w/Cord	\$41.60



Honeywell
HOWARD
LEIGHT

3M™ E-A-R™ Classic™ Earplugs

NRR-29 dB*

- Moisture-resistant—helps maintain a consistent expansion time, even in humid environments.
- Flame resistant — important for potential arc flash situations and for storage considerations.

▶ 200 PAIR PER DISPENSER BOX - 10 BOXES PER CASE.

ITEM NO.	PRODUCT	BOX
6655 64475	Value Pack w/o Cord	\$49.28
6655 22755	Individual Pack w/Cord	107.60

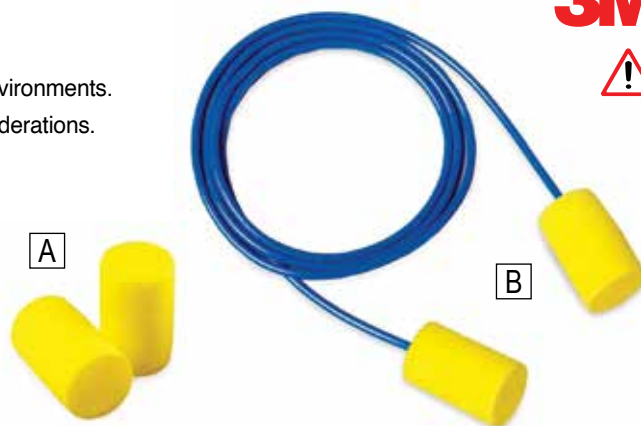

3M



! WARNING on 3M/EAR™ Hearing Protection: These hearing protectors help reduce exposure to hazardous noise and other loud sounds. Misuse or failure to wear hearing protectors at all times you are exposed to noise may result in hearing loss or injury. For proper use, see supervisor, User Instructions, or call 3M in the USA at 1-800-243-4630. In Canada, call Technical Service at 1-800-267-4414. If there is any drainage from your ear or you have an ear infection, consult with your physician before wearing ear plugs. Failure to do so may result in hearing loss or injury. * Research suggests that many users will receive less noise reduction than indicated by the NRR due to variation in earplug fit and wearing time. It is recommended that the NRR be reduced by 50% for estimating the average amount of noise reduction provided.



WorkHorse® Reusable Earplugs

NRR-27

- Four-flange design conforms to the oval shape of the ear for a comfortable fit.
- Stem allows for easy insertion into ear.
- Blue cords and orange earplugs are highly visible.
- Individually poly-bagged.



▶ 100 PAIR PER DISPENSER BOX - 10 BOXES PER CASE - 16 CASES PER PALLET.

ITEM NO.	PRODUCT	BOX
E542 09775	WorkHorse® Flanged Reusable Earplugs	\$79.95

ITEM NO.	PRODUCT	EACH
E542 09771	WorkHorse® Flanged Reusable Earplugs, 1 Polybagged Pair	\$0.90

Tri-Grip Earplugs

NRR-27

- Triangular stem allows for easy insertion into ear with no need to roll or touch plug.
- Individually packaged.

▶ 100 PAIR PER DISPENSER BOX - 4 BOXES PER CASE.

ITEM NO.	PRODUCT	BOX
6152 90105	Tri-Grip w/Cord	\$104.25



AirSoft® Earplugs

NRR-27

- Less pressure in the ear canal eliminates that “plugged up” feeling.
- Sold by the pair.

▶ 100 PAIR PER DISPENSER BOX.

ITEM NO.	PRODUCT	PAIR
3140 45491	Airsoft® w/Red Cord	\$2.45



UltraFit™ Reusable Earplugs

NRR-25 dB*

- Extremely comfortable, non-toxic, non-allergenic polymer.
- Individually poly-bagged. • Sold by the pair.

▶ 200 PAIR PER DISPENSER BOX.

ITEM NO.	PRODUCT	PAIR
3207 40141	UltraFit™ w/Cord	\$2.67



Tri-Flange™ Pre-Molded Earplugs

NRR-26 dB*

- For better hygiene, insertion stem eliminates fingers' need to touch earplug tip.

▶ 100 PAIR PER DISPENSER BOX - 4 BOXES PER CASE.

ITEM NO.	PRODUCT	BOX
6655 63965	Tri-Flange™ w/Cord	\$191.90



! WARNING on 3M/EAR™ Hearing Protection: These hearing protectors help reduce exposure to hazardous noise and other loud sounds. Misuse or failure to wear hearing protectors at all times you are exposed to noise may result in hearing loss or injury. For proper use, see supervisor, User Instructions, or call 3M in the USA at 1-800-243-4630. In Canada, call Technical Service at 1-800-267-4414. If there is any drainage from your ear or you have an ear infection, consult with your physician before wearing ear plugs. Failure to do so may result in hearing loss or injury. * Research suggests that many users will receive less noise reduction than indicated by the NRR due to variation in earplug fit and wearing time. It is recommended that the NRR be reduced by 50% for estimating the average amount of noise reduction provided.



A





B

WorkHorse® Disposable Metal Detectable Earplugs

NRR-33: Tapered NRR-32: Bell-Shaped

- Both earplugs and cords are metal detectable.
- Tapered or bell-shaped designed to fit most ear sizes.
- Constructed of expandable foam for a comfortable seal.
 - Blue cords and earplugs are highly visible.
 - Individually poly-bagged.







▶ 100 PAIR PER DISPENSER BOX - 10 BOXES PER CASE - 16 CASES PER PALLET.

ITEM NO.	PRODUCT	BOX
E542 09465	A. WorkHorse® Disposable, Tapered, Metal Detectable	\$39.95
E542 09485	B. WorkHorse® Disposable, Bell-Shaped, Metal Detectable	39.95

Laser Trak® Detectable Disposable Plugs

NRR-32

- Plugs are detectable. Cords are NOT metal detectable.

▶ 100 PAIR PER DISPENSER BOX - 10 BOXES PER CASE.

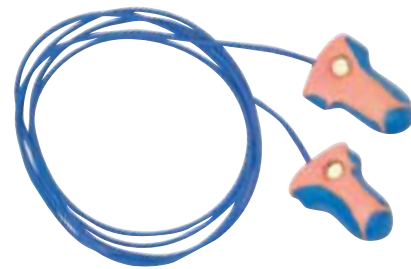

Honeywell
HOWARD LEIGHT

ITEM NO.	PRODUCT	BOX
3140 38745	Laser-Trak® w/Cord	\$95.03

3M™ E-A-Rsoft™ Yellow Neons™ Metal Detectable Corded Earplugs

NRR-33 dB*

- Cord and plugs are metal detectable.
- Corded and packed in individual poly bags.
- Embedded magnetic metal ball bearing allows metal detection.

▶ 200 PAIR PER DISPENSER BOX - 10 BOXES PER CASE.



ITEM NO.	PRODUCT	BOX
6655 74835	E-A-Rsoft™ Yellow Neons™ w/Cord	\$137.75



E542 09765
EARPLUGS REUSABLE METAL DETECTABLE
NRR-27
100 PAIRS

WorkHorse® Reusable Metal Detectable Earplugs

NRR-27

- Both earplugs and cords are metal detectable
- Stem allows for easy insertion into ear.
- Blue cords and earplugs are highly visible.
- Four-flange design conforms to the oval shape of the ear for a comfortable fit.
- Individually poly-bagged.





▶ 100 PAIR PER DISPENSER BOX - 10 BOXES PER CASE - 16 CASES PER PALLET.

ITEM NO.	PRODUCT	BOX
E542 09765	WorkHorse® Reusable, Flanged, Metal Detectable	\$99.95

ITEM NO.	PRODUCT	EACH
E542 09761	WorkHorse® Flanged Reusable Metal Detectable Earplugs, 1 Poly-bagged Pair	\$1.10

SmartFit® Detectable Earplugs

NRR-25

- Cord and plugs are metal detectable.
- Metal ring on stem is detectable by automated equipment.

▶ 100 PAIR PER DISPENSER BOX - 5 BOXES PER CASE.

ITEM NO.	PRODUCT	BOX
3140 50305	SmartFit® w/Cord	\$205.75



Honeywell
HOWARD LEIGHT

Tri-Grip Metal Detectable Earplugs

NRR-27

- Cord and plugs are metal detectable.
- Individually packed.

▶ 100 PAIR PER DISPENSER BOX - 4 BOXES PER CASE.

ITEM NO.	PRODUCT	BOX
6152 90115	Tri-Grip w/Cord	\$132.55
6152 90225	Tri-Grip Junior w/Cord	123.65



TASCO

3M™ E-A-R™ UltraFit™ Earplugs, Metal Detectable, Corded

NRR-25 dB*

- Plugs are metal detectable.
- Individually poly-bagged.
- Sold by the pair.

▶ 200 PAIR PER DISPENSER BOX.

ITEM NO.	PRODUCT	PAIR
6655 22151	Ultrafit™ Detectable w/Cord	\$2.52



3M

! WARNING on 3M/EAR™ Hearing Protection: These hearing protectors help reduce exposure to hazardous noise and other loud sounds. Misuse or failure to wear hearing protectors at all times you are exposed to noise may result in hearing loss or injury. For proper use, see supervisor, User Instructions, or call 3M in the USA at 1-800-243-4630. In Canada, call Technical Service at 1-800-267-4414. If there is any drainage from your ear or you have an ear infection, consult with your physician before wearing ear plugs. Failure to do so may result in hearing loss or injury. * Research suggests that many users will receive less noise reduction than indicated by the NRR due to variation in earplug fit and wearing time. It is recommended that the NRR be reduced by 50% for estimating the average amount of noise reduction provided.

QM24+® Earmuffs

NRR-25

- Dielectric construction suitable for electrical environments.
- Multiple-position headband allows wearer to select over the head, behind the head or under the chin.
- Alternative to cap-mounted earmuffs — wear with hard hats, face shields, respirators and other PPE.
- Ultra light-weight design.



▶ 20 PAIR PER CASE.

ITEM NO.	PRODUCT	PAIR
3140 46201	QM24+® Earmuffs	\$22.22

Honeywell
HOWARD
LEIGHT

Blackhawk Earmuffs

NRR-27

- Dielectric, three position earmuff with special foam head pad for all day comfort.
- 27 NRR over-the-head, 26 NRR under-chin or behind neck.
- Soft-Seal™ ear cushions provide exceptional comfort and fit.
- Sculpted headband with molded grips or easy cup adjustment.
- Consistent full spectrum attenuation.



▶ 20 PAIR PER CASE.

ITEM NO.	PRODUCT	PAIR
6152 94041	Blackhawk Earmuffs	\$18.25

TASCO
MADE IN
USA

Pink Foldable Earmuffs

NRR-23

- Unique folding design allows for convenient storage.
- Foam-filled ear cushions. • Adjustable height.

▶ SEE PAGE 7
For More Pink Products

▶ 12 PAIR PER CASE.

ITEM NO.	PRODUCT	PAIR
3425 42421	Pink Foldable Earmuffs	\$9.95



ERB
Safety Products for LIFE.

VeriShield™ 100 Series Dielectric Earmuffs

NRR-29

- Dielectric construction — suitable for all workplaces, especially electrical environments.
- Sound Management Technology reduces harmful noises without blocking necessary communication.
- Wide cup openings — large enough to fit over hearing aids and reduce pressure and fatigue.
- Oil-resistant coating for use in industrial environments.
- Memory foam cushion for added comfort.



ITEM NO.	PRODUCT	PAIR
3415 84251	100 Series Dielectric Earmuffs	\$42.56

Honeywell
HOWARD
LEIGHT

VeriShield™ 100 Series Hard Hat Earmuffs

NRR-27

- Wide cup opening — Ideal for people with large ears or those who wear hearing aids. Cup increased in size by 16% over earlier versions.
- Steel-wire construction attaches earmuff to hard hat — adapter included.
- Precision micro adjustments on fork slide designed for just the right fit around the ear.
- Memory foam ear cushions combine dense and soft foam for greater comfort and attenuation. Reduces squeezing pressure on the head and enhances comfort.



▶ SEE PAGES 312-313
Hard hat sold separately.

ITEM NO.	PRODUCT	PAIR
3140 01521	Verishield™ Hard Hat Earmuffs	\$44.34

Honeywell
HOWARD
LEIGHT

3M™ PELTOR™ Optime™ Earmuffs

Available in headband, neck band and helmet-attachable models to meet virtually every application.

- Liquid and foam filled cushions and broad, soft rings form a better seal.
- Padded wide headband cushions head while four-point steel suspension band distributes pressure for extra comfort.
- Ear cup pivot-points allow wearers to tilt and adjust ear cups for optimum comfort and efficiency.
- Stainless steel construction resists bending and warping. • Fits most facial profiles.



3M™ PELTOR™ Optime™ 95, Cap Mount

NRR-21

- For noise levels up to 95 dBA.
- For use with hard hats, sold separately.



▶ SEE PAGES 312-313 For Hard Hats

▶ 10 PAIR PER CASE.

ITEM NO.	PRODUCT	PAIR
3207 00261	Helmet Attachable Earmuffs	\$26.62

3M™ PELTOR™ Optime™ 98, Cap Mount

NRR-23

- For noise levels up to 98 dBA.
- For use with hard hats, sold separately.



▶ SEE PAGES 312-313 For Hard Hats

▶ 10 PAIR PER CASE.

ITEM NO.	PRODUCT	PAIR
6655 64051	Helmet Attachable Earmuffs	\$32.80

3M™ PELTOR™ Optime™ 101

For loudest noise levels up to 101 dBA.

NRR from 22-27 depending on how earmuffs are worn.



ITEM NO.	PRODUCT	NRR	PAIR
6655 70071	A. Over-The-Head	27dB	\$44.81
3207 23731	B. Helmet Attachable Earmuff	24dB	

3M™ PELTOR™ Optime™ 105

For extreme noise levels up to 105 dBA.

NRR from 27-30 depending on how earmuffs are worn.



ITEM NO.	PRODUCT	NRR	PAIR
6655 64031	A. Over-The-Head	30dB	\$52.17
6655 70291	B. Behind-The-Head	29dB	
6655 22721	C. Helmet Attachable Earmuff	27dB	

Light-Duty Face Shield*

Anti-fog plastic shield covers your eyes, nose and mouth.

- Anti-fog coating on interior of face shield.
- Lightweight and flexible.
- Protects against splashes and droplets.
- Elastic band ensures one-size-fits-all.
- Fits over prescription glasses.
- Dimensions: 13 inches W x 9 inches L.



Peel-off, scratch-resistant coating protects shield prior to use.



Face Shield can be worn under or over hard hat or bump cap.



▶ 200 PER CASE.

ITEM NO.	PRODUCT	EACH
E542 09941	Light-Duty Face Shield	\$4.95



For More Face Shields ▶ SEE PAGE 299

* Not N95 rated — strictly for nuisance and droplet protection. General use masks, not intended for use by health care professionals. Not impact rated.

V-GARD® Clear Visor

Attaches easily to V-GARD® hard hats by use of frame.

- Frame and face shield visor sold separately.
- Frame required for visor to attach to V-GARD® hard hat.
- V-shaped alignment guides and three touch point load for easy installation.
- Sliding adjustment blades allow visor to work with most half-mask respirators.
- Replaceable debris control creates a tight seal between helmet and frame.



▶ SEE PAGE 313
For V-GARD® Hard Hats,
Sold Separately

ITEM NO.	PRODUCT	EACH
3085 850D1	V-GARD® Frame	\$22.82
3085 355E1	Clear Visor.	11.00

Washable Hard Hat Sweat Band

- Comfortable, absorbent terry cloth that attaches to protective head gear suspension band.
- Elastic band and Velcro® strips for easy attachment.
- 1/2-inch foam insert for extra soft padding.



▶ SEE PAGES 312-313
Hard Hats and Bump Caps
Sold Separately

ITEM NO.	PRODUCT	EACH
3407 38751	Deluxe Sweat Band.	\$7.30

Disposable Sweat Band



- Rinse sweatband with cool water before and after each use to remove perspiration.
- Sanitized sponge absorbs perspiration.
- Store in a well-ventilated place and re-wet to reuse.



▶ SEE PAGES 312-313
Hard Hats and Bump Caps
Sold Separately

▶ 25 PER BAG.

ITEM NO.	PRODUCT	BAG
C241 2308	Disposable Sweat Band	\$51.50

Standard Bump Cap

- Molded from High Density Polyethylene (HDPE).
- Great for areas that require light head protection.
- Light-weight, smooth, dome design.
- Four-point adjustable plastic suspension system.
- Not ANSI compliant.
- Adjusts to fit sizes 6-1/2 to 8-1/4 inches.



Plastic suspension system with Coolmax® terry cloth sweatband.

JACKSON
SAFETY

MADE IN
USA

ITEM NO.	COLOR
C241 15451	Orange
C241 15431	Green
C241 15421	White
C241 15461	Red
C241 15471	Gray
C241 15411	Yellow
C241 15441	Blue

► 12 PER CASE.

EACH

\$14.62

ITEM NO.	PRODUCT	EACH
C241 20531	Replacement Suspension	\$19.31



Safety Bump Cap

Ideal for protecting head from lacerations and minor bumps in areas that do not require certified safety helmets.

- Pinlock suspension adjusts to fit 6-1/2 to 7-3/4 inches.
- Side vented to keep cool.
- Light-weight, 7.34 ounces.

ITEM NO.	COLOR
3425 00701	Red
3425 91231	Hi-Vis Orange
3425 00691	Yellow
3425 00681	White
3425 00671	Orange
3425 00721	Green
3425 00711	Blue
3425 91251	Hi-Vis Lime
3425 00731	Black
3425 00011	Gray
3425 00741	Hi-Vis Yellow
3425 91261	Beige

► 12 PER CASE.

EACH

\$4.95



Moisture wicking brow pad is removable, washable and replaceable.

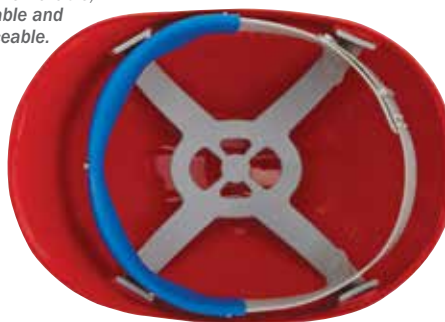

ITEM NO.	PRODUCT	EACH
3425 91245	Replacement Brow Pad (Box of 12) . . .	\$14.95



MADE IN
USA



! CAUTION: The bump caps shown above DO NOT meet ANSI Z89.1 or CSA Z 94.1. They are not meant to be worn for protection from impact of falling or glancing objects.



V-GARD® Safety Hard Hat

Lightweight and comfortable to wear all day.

- Injection molded of non-conductive high-density polyethylene. • Includes Staz-On suspension.
- Meets requirements for Type 1, ANSI Z89.1-2014 and CSA Z94.1-2015 (Class E).
- Provides a minimum safety crown clearance of 1-1/4 inches between top of head and shell.
- Choose from 13 colors. • Product of the USA.

ITEM NO.	COLOR
3085 71271	White
3085 71291	Green
3085 71281	Blue
3085 71301	Yellow
3085 71311	Red
3085 71321	Orange
3085 71331	Gray
3085 48511	Gold
3085 11801	Tan
3085 31111	Light Blue
3085 11241	Burgundy
3085 53641	Pink

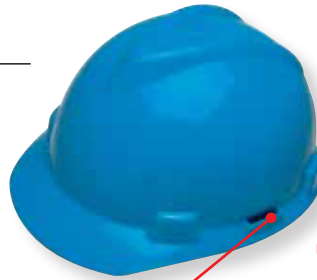

Slotted design for hard hat accessories

▶ 20 PER CASE.



ITEM NO.	PRODUCT	EACH
3085 52301	Hot Pink w/Ratchet Suspension	\$20.17

▶ 20 PER CASE.

EACH
\$14.29



Includes Staz-On Suspension.



Optional ratchet-style replacement suspension.

ITEM NO.	PRODUCT	EACH
3085 79211	Replacement Staz-On Suspension	\$12.99
3085 87081	Replacement Ratchet Suspension	20.73

ERB Americana Safety Cap with 4-Point Slide-Lock Suspension



- Meets ANSI/ISEA Z89.1, TYPE 1 Class C, E and G.
- Moisture-wicking brow pad is removable, washable and replaceable.
- Accessory slots accommodate a variety of eye, face and hearing products.
- 4-point woven nylon suspension. • Accommodates a chin strap.
- Goggle retaining slots on suspension. • Molded from high density polyethylene.



4-Point Slide-Lock Suspension



Easy Quick-Slide sizing adjusts to fit head sizes 6-1/2-8.

ITEM NO.	COLOR
3425 00251	Blue
3425 00871	Green
3425 00291	Yellow
3425 97631	Orange
3425 97641	Red
3425 97611	White
3425 00241	Gray
3425 00261	Black

Optional vented.

EACH
\$7.95



ITEM NO.	PRODUCT	EACH
3425 92511	White, Vented	\$8.95

Multi-Use, Water Resistant 80 Lumen Headlight

- High performance Cree LED.
- 80 lumens (target).
- Multi-use: headlight, magnet, hat clip, helmet.
- Includes 2 headstraps: cloth for wearing on head and rubber grip for helmet use.
- Uses 3 AAA batteries, (included).

80
LUMENS



RAYOVAC



ITEM NO.	PRODUCT	EACH
7784 20031	Multi-Use 80 Headlight	\$21.95

Rack 'Em™ Hard Hat Rack

Organizes and stores hard hats in one place.

- Heavy-duty galvanized steel construction with black PVC coating.
- Screws supplied for easy mounting.
- Holds four hard hats.
- Dimensions: 10 inches x 16-1/2 inches.



RACK'EM™

MADE IN
USA

**NOTE: Hats
sold separately.**

ITEM NO.	PRODUCT	EACH
3446 50041	Hard Hat Racks	\$49.95

Hard Hat Clip

Handy clip for holding eyewear, pencils or personal items.

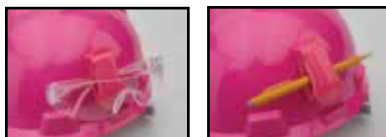

**NOTE: Hard hats and
glasses sold separately.**



▶ 12 PER CASE.

ITEM NO.	PRODUCT	EACH
3425 56441	Hard Hat Clip	\$2.95

ERB
Safety Products for LIFE.

MADE IN
USA

3M™ Web Series Shock Absorbing Lanyard

- Dissipates the energy of a fall over a longer period of time instead of snapping to a halt.
- Constructed of 1-3/8-inch tubular nylon webs with self locking snap hooks at each end.
- To be used in conjunction with a fall arrestor.



ITEM NO.	PRODUCT	EACH
4580 0006	6' Lanyard	\$159.63

3M™ Shockwave™ 2 Lanyard

- Stretchable for complete freedom of movement.
- Expands to 6 feet and contracts to 4-1/2 feet in reaction to movements reducing trip fall hazards, dragging and snagging.
- In case of a fall, unique inner core extends and absorbs energy, limiting arresting forces to 900 pounds or less.
- Abrasion-resistant polyester tubular webbing.
- Self-locking snap hooks at ends.
- Impact indicator.

3M

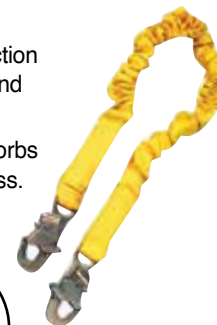

F.O.B. FACTORY
EACH

ITEM NO.	PRODUCT	EACH
4580 20121	Lanyard	\$160.84

3M™ Pass-thru Tie-off Adapter

- Easy-to-use, light-weight with 5,000 pounds minimum tensile strength.
- 1-3/4-inch polyester strength member.
- 3-inch wide polyester wear pad.
- Length: 3 feet.

3M



ITEM NO.	PRODUCT	F.O.B. FACTORY EACH
4580 3000	Pass-Thru Adapter	\$92.71

3M™ Full-Body Harness



- Harness comes complete with back D-ring for fall arrest, chest strap parachute adjuster buckles on shoulder straps and tongue buckle leg straps. Distributes the force of a fall over the torso and thighs to minimize injury.
- Universal design fits individuals of any size.



BUNZL
Processor Division
KOCH SUPPLIES

FREE SHIPPING*

FREE GROUND SHIPPING
when you place an order for \$500 or more from THIS BUYERS GUIDE!

*FREE SHIPPING does NOT include UPS Next Day Air, UPS 2nd Day or UPS 3rd Day Select. Certain items may not qualify. This offer is good only on orders shipped UPS Ground in the 48 contiguous states. Based on dimensional weight, we will determine the most efficient means of shipment, either UPS or LTL. Products may ship by truckline.

ITEM NO.	PRODUCT	EACH
4580 2000	Full-Body Harness	\$221.59

3M™ DBI-SALA® Nano-Lok™ Extended Length Self Retracting Lifeline



- Cab-mount bracket and mounting hardware.
- Dyneema® fiber and polyester web lifeline.
- Self-locking snap hook.
- Extremely compact, light-weight design.
- Weight capacity: 420 pounds.
- Length: 11 feet.



ITEM NO.	PRODUCT	EACH
4580 13901	11' Self-Retracting Lifeline	\$410.64

3M™ Protecta® Rebel™ 11-Foot Self-Retracting Lifeline



- Rugged, light-weight thermoplastic housing.
- Stackable housing design.
- Built-in carrying handle.
- 33-foot (10 m) 3/16-inch (5 mm) stainless steel cable lifeline.
- Swiveling self-locking snap hook with impact indicator.
- Speed sensing all metal brake system.
- Internal energy absorption system.
- Reserve lifeline system.
- Side lifeline exit with ergonomic handle.
- High strength, corrosion resistant components.
- Swiveling anchorage point.
- Self-locking anchorage carabiner.



ITEM NO.	PRODUCT	EACH
4580 14261	11' Self-Retracting Lifeline	\$298.21

7.4-Ounce Hi-Visibility Cooler Jackets and Vests

ANSI/ISEA 107-2020 Class 2.

- Insulated with a full 7.4 ounces of DuPont Dacron 808® fiber fill.
- 100% nylon outer shell. • Heavy-duty brass zipper.
- 2 insulated hand warmer pockets. • Machine washable.

KOOLERWEAR

MADE IN
USA

A. Hi-Viz Jacket

ITEM NO.	SIZE
4648 49601	Small
4648 49611	Medium
4648 49621	Large
4648 49631	X-Large

▶ 6 PER CASE.

EACH

\$80.35

B. Hi-Viz Vest

ITEM NO.	SIZE
4648 49501	Small
4648 49511	Medium
4648 49521	Large
4648 49531	X-Large

▶ 6 PER CASE.

EACH

\$60.05

▶ SEE PAGE 33
For Blue Koolerwear Options



Safety Vests

Not ANSI/ISEA 107 Compliant.

- Hi-Viz orange or pink color. • Made of polyester fabric.
- Choose from vest with or without reflective tape.
- No pockets. • Hook and loop closure.
- Elastic side straps. • One size fits all.

NOTE:
Hats sold separately.



ITEM NO.	PRODUCT	EACH
3314 22011	A. Orange, Mesh, No Stripe	\$4.95
3463 01071	B. Orange, Mesh w/1-2/5" Gloss Yellow Reflective Stripe	5.05
3425 17281	C. Pink, Solid w/Silver Reflective Stripe	8.30



NEED ASSISTANCE?

Our experienced customer service representatives are available to answer your questions, find the products you are looking for, check product availability, as well as take your order.

800-456-5624

Mesh or Solid Fabric Safety Vests

ANSI/ISEA 107-2020 Class 2.

- Choose either Hi-Viz orange or yellow with 2-inch silver reflective tape.
- Made of polyester fabric. • Hook and loop closure.
- No pockets.



Mesh Vest

ITEM NO.	SIZE	COLOR
6292 12301	Medium . .	Yellow
6292 12311	Large . . .	Yellow
6292 12321	X-Large . .	Yellow
6292 12351	Medium . .	Orange
6292 12361	Large . . .	Orange
6292 12371	X-Large . .	Orange

EACH
\$7.85

Solid Vest

ITEM NO.	SIZE	COLOR
6292 12401	Medium . .	Yellow
6292 12411	Large . . .	Yellow
6292 12421	X-Large . .	Yellow
6292 12451	Medium . .	Orange
6292 12461	Large . . .	Orange
6292 12471	X-Large . .	Orange

EACH
\$9.45

Polyester Breakaway Safety Vests

ANSI/ISEA 107-2020 Class 2.

- Choose either Hi-Viz orange or yellow, both with 2-inch silver reflective tape.
- Two internal lower pockets, one external chest pocket with pen pocket.
- Five point breakaway.
- Made of polyester fabric.
- Hook and loop closure.



ITEM NO.	SIZE	COLOR
6292 12011	Medium . .	Yellow
6292 11921	Large . . .	Yellow
6292 12031	X-Large . .	Yellow
6292 12051	Medium . .	Orange
6292 11961	Large . . .	Orange
6292 12071	X-Large . .	Orange

EACH
\$18.65

SURVO Safety Vest

ANSI/ISEA 107-2020 Class 2.

- Made of orange polyester fabric.
- 3-inch lime and silver reflective stripes.
- Two internal pockets; four external pockets, two with flaps, one pocket sewn into four sections to hold pencils.
 - Zipper closure.



ITEM NO.	SIZE
3314 45111	Small
3314 41401	Medium
3314 39691	Large
3314 39681	X-Large
3314 39671	2X-Large
3314 39701	3X-Large
3314 42721	4X-Large

EACH
\$14.35

Mesh Fabric Zip-Up Vest

ANSI/ISEA 107-2020 Class 2.

- Two lower internal pockets, two upper chest pockets including four pen pockets.
- Hi-Viz yellow with 2-inch silver reflective tape.
- Made of polyester fabric.
- Zipper closure.



ITEM NO.	SIZE
6292 12501	Medium
6292 12511	Large
6292 12521	X-Large

EACH
\$12.25

CHOOSING A RESPIRATOR

Check the SDS for your substance to select the appropriate respirator, one must know the contaminants from which they need protection.

Details on various substances can usually be found on the SDS if the contaminant is a raw material used in production. If the contaminant is some type of by-product of a work process, more extensive investigation as to what the contaminant is composed of may be required. Once the contaminant has been identified, it is necessary to determine its concentration by performing air sampling in the work area.

Some other factors to take into account when choosing a respirator are the length of time the worker is exposed to the contaminants, specific conditions at the workplace, whether the workplace is indoors or outdoors, other types of personal protective equipment that is being used and whether chemical exposures may occur at the workplace.

Taking these findings into account, there are two types of respirators from which to choose, with many types of cartridges and filters that are used to block various gases and/or chemicals. These cartridges fit both half mask and full face piece type respirators. The half-mask respirator follows the contours of your face and fits over your nose and under your chin. It grants you a wider field of vision than a full face piece respirator and allows you to wear most types of eyewear along with the mask. Full face piece respirators fit under your chin and over your head and provide the same protection as a half-mask respirator. However, a full face piece respirator protects your eyes and face from airborne particles, chemicals and gases that could damage a worker's eyes.

RESISTANCE TO DEGRADATION		FILTER EFFICIENCY LEVELS		
		95%	99%	100%*
N	Non-Oil Solid particulates and non-oil aerosols that do not degrade filter performance.	N95	N99	N100
R	Oil-Resistant Solid particulates and degrading oil based aerosols. 8 hour use limitation.	R95	R99	R100
P	Oil-Proof Solid particulates and oil based aerosols. No use limitations.	P95	P99	P100

* Actual filter efficiency level is 99.97%.

SHOP 24/7

bunzlpd.com

Where you can find out what's on sale, find updated product information, reviews and pricing.



Need Help?
Chat With Us
Online!

STAY CONNECTED WITH US:



7000 Series Half Mask Respirator

Fewer parts, minimal maintenance and a wider field of vision.

- Ultra light-weight, durable and economical, so maximum comfort with extended use is built-in.
- Compact to easily fit under welding helmets. • Features optional drop down/lock down strap modes.
- Contoured neck buckles for comfort and quick attachment.
- NIOSH approved.



All Moldex products and packaging are 100% PVC-Free for a greener alternative.



Drop down mode.



Contoured neck buckles for comfort and quick attachment.



Attached exhale cover for easy inspection.



Easy mount bayonet cartridge/filter attachment.



ITEM NO.	PRODUCT	SIZE	EACH
2222 70011	7000 Series Half Mask	Small	\$23.26
2222 70021	7000 Series Half Mask	Medium	23.26
2222 70031	7000 Series Half Mask	Large	23.26
2222 73001	A. Organic Vapors/Acid Gases Cartridge, Yellow (1 Pair)		18.11
2222 74001	B. Ammonia/Methylamine Cartridge, Green (1 Pair)		22.94



Adjustable straps don't fall into the field of vision.

8000 Series Half Mask Respirator

- Inhalation valve is replaced with every cartridge preventing bacteria build up.
- Soft, durable respirator is comfortable to wear and provides a wide field of vision.
- Snap-mount cartridge has no valves, allowing for minimal cleaning and maintenance. • NIOSH approved.



Cartridges and Filters

- Olive Multi-Gas/Vapor Smart® Cartridge protects against Organic Vapors, Chlorine, Hydrogen Chloride, Sulfur Dioxide, Hydrogen Sulfide (for escape only), Hydrogen Fluoride, Chloride Dioxide, Ammonia, Methylamine and Formaldehyde. Can be combined with White N95 Particulate Filter for added protection.
- White N95 Filter protects against solid non-oil based particulates. Provides 95% minimum efficiency. With the use of the filter retainer
- This filter can be combined with the Smart® Cartridge for added protection.

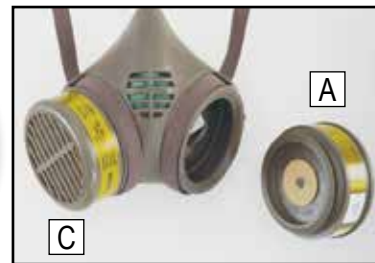
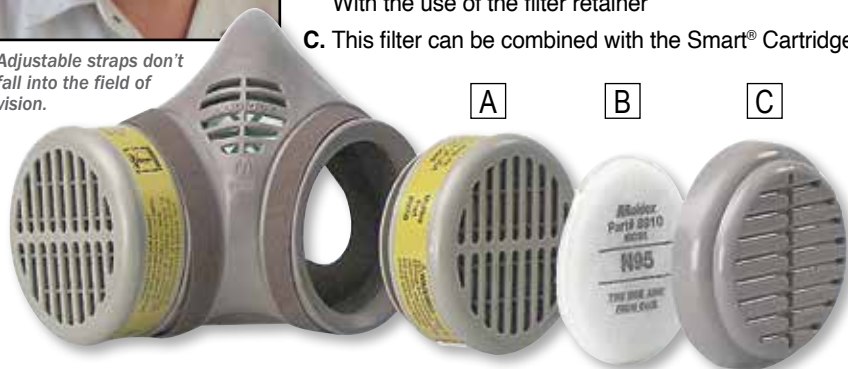

All Moldex products and packaging are 100% PVC-Free for a greener alternative.

ITEM NO.	PRODUCT	SIZE	EACH
2222 80021	8000 Series Half Mask	Medium	\$24.41
2222 80031	8000 Series Half Mask	Large	24.41
2222 42541	A. Multi-Gas/Vapor Smart® Cartridge (1 Pair)		22.00
2222 43425	B. White N95 Particulate Pre-Filter (Pack of 5)		26.62
2222 30221	C. Retainer for White Particulate Filter (Pack of 2)		7.19



Inhalation valve is built into cartridge, not into the mask itself. No valves on the mask to clean — remove all bacteria with every cartridge change!



3M Gas and Vapor Cartridges

Ammonia Methylamine Cartridge

Green

ITEM NO.	QTY.	MFR. NO.	PACK
6655 13315	2/Pack	6004	\$26.72



Organic Vapor/Acid Gas Cartridge

Yellow

ITEM NO.	QTY.	MFR. NO.	PACK
6655 01145	2/Pack	6003	\$25.48

Certain organic vapors, chlorine, hydrogen chloride, sulfur dioxide, hydrogen sulfide or hydrogen fluoride.



3M™ Multi-Gas/Vapor Cartridge

Olive

ITEM NO.	QTY.	MFR. NO.	PACK
6655 13325	2/Pack	6006	\$25.37

Certain organic vapors, chlorine, hydrogen chloride, sulfur dioxide, chlorine dioxide, hydrogen sulfide, ammonia, methylamine, dehyde, or hydrogen fluoride.



Combination Gas and Vapor Cartridges with P100 Particulate Filters

3M™ Ammonia/Methylamine Cartridge/Filter

Green and Magenta

ITEM NO.	QTY.	MFR. NO.	PACK
6655 13385	2/Pack	60924	\$50.30

With a P100 Particulate Filter (99.97% minimum filter efficiency).



3M™ Multi-Gas/Vapor Cartridge/Filter

Olive and Magenta

ITEM NO.	QTY.	MFR. NO.	PACK
6655 13405	2/Pack	60926	\$43.99

Certain organic vapors, chlorine, hydrogen chloride, sulfur dioxide, chlorine dioxide, hydrogen sulfide, ammonia, methylamine, formaldehyde or hydrogen fluoride with a P100 particulate filter (99.97% minimum filter efficiency).



SPECIAL ORDER ITEM Particulate Filters

3M™ Particulate Filter, P95

For use WITH 6000 Series cartridges shown above.

ITEM NO.	QTY.	MFR. NO.	PACK
6655 12075	10/Pack	5P71	\$44.99

(95% minimum filter efficiency).



3M™ Half Facepiece Reusable Respirator 6000 Series

An economical alternative to silicone.

- Face piece is constructed of soft, light-weight thermoplastic elastomer.
- Low-profile design for better vision and to accommodate safety glasses.
- Easy-to-adjust straps for fit and worker compliance.
- NIOSH approved with interchangeable 3M™ filters and cartridges.



NOTE: Order cartridges and filters separately, SEE LEFT.

ITEM NO.	SIZE	MRF. NO.	EACH
6655 01761	Medium	6200	\$26.31

3M™ Half Facepiece Reusable Respirator 7500 Series

A softer feel and more comfortable!

- 3M™ Cool Flow™ exhalation valve provides cool, dry comfort and acts as a downshield during welding or grinding applications — helping to prevent fogging.
- Drop-down harness allows the wearer to lower the respirator without removing welding shield, hard hat or face shield.
- Uses interchangeable filters and cartridges.
- NIOSH approved with 3M™ filters and cartridges.



NOTE: Order cartridges and filters separately, SEE LEFT.



ITEM NO.	SIZE	MRF. NO.	F.O.B. FACTORY EACH
6655 14061	Medium	7502	\$46.20
6655 14801	Large	7503	46.20

3M™ Full Facepiece Reusable Respirator 6000 Series

Full facepiece respirators need to be used for applications involving ammonia or similar gases.

- Constructed of thermoplastic elastomer nose cup and silicone face seal with lends for wide field of vision.
- Includes a downshield adapter that directs air and moisture downward.
- Uses interchangeable filters and cartridges.
- NIOSH approved with 3M™ filters and cartridges.



NOTE: Order cartridges and filters separately, SEE LEFT.

ITEM NO.	SIZE	MRF. NO.	EACH
6655 13871	Large	6900	\$226.53



IMPORTANT: The 3M™ products on this page must be used in accordance with OSHA regulations and the user instructions, warnings and limitations accompanying each product.

5500 Series Low Maintenance Half Mask Respirator

An economic alternative to silicone.

- Light-weight, thermoplastic elastomer face piece.
- Only nine replacement parts for quick and easy strip down for cleaning.
- Can be adapted to PAPR or supplied air for added flexibility in the workplace.
- NIOSH approved when used with North filters and/or cartridges.



Honeywell
NORTH

NOTE: Order cartridges and filters separately, SEE RIGHT.

ITEM NO.	SIZE	MRF. NO.	EACH
3476 57231	Medium	550030M	\$21.18
3476 57241	Large	550030L	21.18

7700 Series Silicone Half Mask Respirator

Constructed of soft, comfortable silicone.

- Pressure seal checks can be performed without removing filters or cartridges.
- Only nine replaceable parts to help reduce cleaning time.
- Can be adapted to PAPR or supplied air for added flexibility in the workplace.
- NIOSH approved when used with North filters and/or cartridges.



Honeywell
NORTH

NOTE: Order cartridges and filters separately, SEE RIGHT.

ITEM NO.	SIZE	MRF. NO.	EACH
3476 57201	Medium	770030M	\$44.00
3476 57211	Large	770030L	44.42

7600 Series Silicone Full-Face Respirator

Protects eyes and face from irritating gas, vapors and flying particles.

- Silicone construction provides unparalleled comfort while maintaining a superior fit for most faces.
- Impact-resistant lens provides a 200° field of vision and meets impact and penetration requirements of ANSI Z87.1-1989.
- Includes a five-strap head harness, nose cup and speech diaphragm.
- Can be adapted to PAPR or supplied air for added flexibility in the workplace.
- NIOSH approved when used with North filters and/or cartridges.



Honeywell
NORTH

NOTE: Order cartridges and filters separately, SEE RIGHT.

F.O.B. FACTORY			
ITEM NO.	SIZE	MRF. NO.	EACH
3476 5718	Medium/Large	76008A	\$347.92

N-Series Gas and Vapor Cartridges

Honeywell
NORTH

Ammonia and Methylamine Cartridge

Green

ITEM NO.	MFR. NO.	EACH
3476 75001	N75004L	\$18.78



Organic Vapor and Acid Gas Cartridge

Yellow

ITEM NO.	MFR. NO.	EACH
3476 57485	N75003L	\$17.38

(Chlorine, Hydrogen Chloride, Sulfur Dioxide, Hydrogen Fluoride, Hydrogen Sulfide and Chlorine Dioxide)



Defender™ Multi-Purpose Cartridge

Olive

ITEM NO.	MFR. NO.	EACH
3476 82441	75SCL	\$15.16

(Organic Vapor, Ammonia, Methylamine, Formaldehyde and Acid Gas [Chlorine, Hydrogen Chloride, Sulfur Dioxide, Hydrogen Sulfide [escape] Hydrogen Fluoride, Chlorine Dioxide])



Combination Gas and Vapor Cartridges with P100 Particulate Filters

Ammonia and Methylamine Cartridge

Green and Magenta

ITEM NO.	MFR. NO.	EACH
3476 57451	7584P100L	\$35.13

With a P100 Particulate Filter (99.97% minimum filter efficiency) for all particulates.



Organic Vapor and Acid Gas Cartridge

Yellow and Magenta

ITEM NO.	MFR. NO.	EACH
3476 31001	7583P100L	\$34.64

(Chlorine, Hydrogen Chloride, Sulfur Dioxide, Hydrogen Fluoride, Hydrogen Sulfide and, Chlorine Dioxide) with a P100 Particulate Filter (99.97% minimum filter efficiency) for all particulates.



F.O.B. FACTORY

Defender™ Multi-Purpose Cartridge and P100 Particulate Filter

Olive and Magenta

ITEM NO.	MFR. NO.	EACH
3476 37001	75SCP100L	\$34.64

Organic Vapor, Ammonia, Methylamine, Formaldehyde and Acid Gas (Chlorine, Hydrogen Chloride, Sulfur Dioxide, Hydrogen Sulfide, Hydrogen Fluoride, Chlorine Dioxide) with a P100 particulate filter (99.97% minimum filter efficiency) for all particulates.



SPECIAL ORDER ITEM

Particulate Filters

N95 Non-Oil Particulate Filter/Retainer

For non-oil based aerosol particulates.

ITEM NO.	PRODUCT	QTY.	MFR. NO.	PACK
3476 37021	Filter	10/Pack	7506N95	\$16.13
3476 00361	Retainer	2/Pack	N750036	5.83

(95% minimum filter efficiency.)

WorkHorse® N95 Molded Respirators*

Available with or without a valve.

- Economical, particulate respirator N95 approved.
- Dual-welded, blue head straps eliminate staples and are visually detectable.
- Shell resists collapsing in heat and humidity.
- Facepiece is naturally contoured without pressure points.



Head strap is heat sealed to mask — no staples that can fall into food.

► 12 PER BOX - 20 BOXES PER CASE - 18 CASES PER PALLET.

ITEM NO.	PRODUCT	BOX
E542 09315	WorkHorse® N95 Molded w/Valve	\$20.95



► 20 PER BOX - 20 BOXES PER CASE - 18 CASES PER PALLET.

ITEM NO.	PRODUCT	BOX
E542 09305	WorkHorse® N95 Molded w/o Valve	\$18.95



*Not for medical use.

2300N95 Respirator w/Valve

- Particulate respirator (N95) approved.
- For use against particulate aerosols free of oil.
- Includes exhalation valve to reduce hot air build-up.

▶ 10 PER BOX - 10 BOXES PER CASE.

ITEM NO.	PRODUCT	BOX
2222 00955	Medium/Large	\$33.76



2200N95 Series Respirator

- Particulate respirator (N95) approved.
- For use against particulate aerosols free of oil.
- Soft foam nose cushion for added support.

▶ 20 PER BOX - 12 BOXES PER CASE.

ITEM NO.	PRODUCT	BOX
2222 05565	Small	\$26.42



4200 N95 AirWave® Disposable Respirator

- Dura-Mesh® shell resists collapsing and eliminates the need for nose clips.
- Exclusive easy-breathing wave design allows more airflow in and out of the respirator for cool comfort and easier breathing.
- Soft foam nose cushion and contour shaped for comfort.
- Flexfit design moves with your face.

▶ 10 PER BOX - 8 BOXES PER CASE.

ITEM NO.	PRODUCT	BOX
2222 42005	Medium/Large	\$27.65



Wave design allows more airflow.



SAF-T-FIT Plus N95 Respirators

- Molded cup design with boomerang nose seal and valve.
- Incorporates humidity-resistant filter media.
- Low breathing resistance.
- Light-weight design.
- Durable suspension straps.
- Nose clip is color-coded for visible size recognition.
- Packaged to maintain integrity of product in work environment.

▶ 20 PER BOX - 10 BOXES PER CASE.

ITEM NO.	PRODUCT	BOX
3415 23235	Medium/Large	\$57.49





WorkHorse® Disposable Facemask with Ear-Loops*

These 3-ply, fluid-resistant masks are constructed of a soft pleated material for optimum comfort.

- Disposable 3-ply face mask with pleats, resistant to fluids and dust.
- Soft, non-woven fabric is comfortable to wear with easy breathability.
- Elastic ear-loops allows mask to fit most faces with minimum pressure on ears.
- Adjustable flat nosepiece allows for custom fit.

ASTM LEVEL 1

BFE ≥ 95**

▶ 50 PER BOX - 60 BOXES PER CASE.

ITEM NO.	PRODUCT	BOX
E542 09915	WorkHorse® Disposable Mask	\$7.95

*General use masks, not intended, for use by health care professionals. NOT FOR MEDICAL USE.

**Ideal for procedures where low amounts of fluid, spray and/or aerosols are produced.



3M™ Particulate Respirator 8511, N95

- Ideal for work settings involving heat, humidity or long periods of wear.
- Patented Cool Flow™ one way valve offers easy exhalation and cool, dry comfort.
- Adjustable M-noseclip provides custom fit and secure seal.
- Meets NIOSH 42 CFR84 N95 and TC-84A-1299 standards.

▶ 10 PER BOX - 8 BOXES PER CASE.

ITEM NO.	PRODUCT	BOX
6655 85115	8511 Respirator	\$34.33



3M



3M™ Particulate Respirator 8210, N95

- N95 approved. • Meets 42 CFR84 and NIOSH approval TC-84A-0007.
- Light-weight, for general non-oil particle exposures or short-time use when heat, humidity or sparks are not present.

▶ 20 PER BOX - 8 BOXES PER CASE.

ITEM NO.	PRODUCT	BOX
6655 01755	8210 Respirator	\$30.98



3M



! WARNING on 3M Respiratory Protection: These respirators help reduce exposure to certain airborne contaminants. Before use, the wearer must read and understand the USER Instructions provided as a part of the product packaging. A written respiratory protection program must be implemented meeting all the requirements of OSHA 1910-134 including training, fit testing and medical evaluation. In Canada, CSA standards Z94.4 requirements must be met and/or requirements of the applicable jurisdiction, as appropriate. Misuse may result in sickness or death. For proper use, see packaging instructions, supervisor, or call 3M OH&ESD Technical Service in USA at 1-800-243-4630 and in Canada at 1-800-267-4414.



**SIGN UP
FOR OUR
eDEALS**

Get exclusive offers not found anywhere else!

**eDEAL SIGN-UP FORM
AVAILABLE ON OUR WEBSITE.**

www.bunzlpd.com

WorkHorse® Cut-Resistant Gloves

Constructed of spun threads with fully encapsulated glass fibers and stainless steel.

- FDA-compliant antimicrobial fibers meet USDA food handling requirements.
- Exceptional comfort that is 100% latex and silicone free.
- Resistant to acids, alkali and organic solvents.
- Extended cuff offers extra cut protection around the wrist.
- Machine washable.
- Antimicrobial fiber.
- Ambidextrous.
- Sold per glove, 6 gloves per case.



ANSI/ISEA 105-2016 Rating Chart

A Higher the cut level
= more cut protection

CUT LEVEL	WEIGHT* (GRAMS)
	0 - 199
A1	200-499
A2	500-999
A3	1000-1499
A4	1500-2199
A5	2200-2999
A6	3000-3999
A7	4000-4999
A8	5000-5999
A9	6000+

*Weight needed to cut through material with 25 mm of blade travel.

GAUGE LEVEL

Gauge indicates thickness of threads used in the glove.

Higher the gauge
= thinner threads
for more flexibility.



A4



Standard Cuff

Gray

ITEM NO.	SIZE	CUFF
E542 85001	X-Small	Green
E542 85011	Small	White
E542 85021	Medium	Red
E542 85031	Large	Blue
E542 85041	X-Large	Orange

White

ITEM NO.	SIZE	CUFF
E542 85051	X-Small	Green
E542 85061	Small	White
E542 85071	Medium	Red
E542 85081	Large	Blue
E542 85091	X-Large	Orange

GLOVE
\$9.95

A5



Standard Cuff

Gray

ITEM NO.	SIZE	CUFF
E542 85101	X-Small	Green
E542 85111	Small	White
E542 85121	Medium	Red
E542 85131	Large	Blue
E542 85141	X-Large	Orange

White

ITEM NO.	SIZE	CUFF
E542 85151	X-Small	Green
E542 85161	Small	White
E542 85171	Medium	Red
E542 85181	Large	Blue
E542 85191	X-Large	Orange

GLOVE
\$8.95



Standard Cuff

Gray

ITEM NO.	SIZE	CUFF
E542 85201	X-Small	Green
E542 85211	Small	White
E542 85221	Medium	Red
E542 85231	Large	Blue
E542 85241	X-Large	Orange

White

ITEM NO.	SIZE	CUFF
E542 85251	X-Small	Green
E542 85261	Small	White
E542 85271	Medium	Red
E542 85281	Large	Blue
E542 85291	X-Large	Orange

GLOVE
\$10.95

Extended Cuff

Gray

ITEM NO.	SIZE	CUFF
E542 85301	X-Small	Green
E542 85311	Small	White
E542 85321	Medium	Red
E542 85331	Large	Blue
E542 85341	X-Large	Orange

White

ITEM NO.	SIZE	CUFF
E542 85351	X-Small	Green
E542 85361	Small	White
E542 85371	Medium	Red
E542 85381	Large	Blue
E542 85391	X-Large	Orange

GLOVE
\$11.95



Extended Cuff

In the food processing industry **70% OF WORKERS** who suffered hand injuries were **NOT** wearing protective gloves.

Indirect costs can include **LOST WORKER PRODUCTIVITY** (potentially running into the 10's of thousands of dollars), cost of training replacement employees, damage to workers' morale and **COMPANY REPUTATION**.



Standard Cuff

The average hand injury bill **EXCEEDS \$6,000**, with each workers' compensation claim reaching **\$7,500**.

A6



Standard Cuff

Gray

ITEM NO.	SIZE	CUFF
E542 85601	X-Small . . Green	
E542 85611	Small White	
E542 85621	Medium . . Red	
E542 85631	Large Blue	
E542 85641	X-Large . . Orange	
E542 06501	2X-Large . Gray	

White

ITEM NO.	SIZE	CUFF
E542 85651	X-Small . . Green	
E542 85661	Small White	
E542 85671	Medium . . Red	
E542 85681	Large Blue	
E542 85691	X-Large . . Orange	

GLOVE
\$8.95

Extended Cuff

Gray

ITEM NO.	SIZE	CUFF
E542 33001	X-Small . . Green	
E542 33011	Small White	
E542 33021	Medium . . Red	
E542 33031	Large Blue	
E542 33041	X-Large . . Orange	

White

ITEM NO.	SIZE	CUFF
E542 33101	X-Small . . Green	
E542 33111	Small White	
E542 33121	Medium . . Red	
E542 33131	Large Blue	
E542 33141	X-Large . . Orange	

GLOVE
\$10.95

A9



Standard Cuff

White Only

ITEM NO.	SIZE	CUFF
E542 85751	X-Small . . Green	
E542 85761	Small White	
E542 85771	Medium . . Red	
E542 85781	Large Blue	
E542 85791	X-Large . . Orange	

GLOVE
\$14.95

A6



Standard Cuff

Gray

ITEM NO.	SIZE	CUFF
E542 85401	X-Small . . Green	
E542 85411	Small White	
E542 85421	Medium . . Red	
E542 85431	Large Blue	
E542 85441	X-Large . . Orange	

White

ITEM NO.	SIZE	CUFF
E542 85451	X-Small . . Green	
E542 85461	Small White	
E542 85471	Medium . . Red	
E542 85481	Large Blue	
E542 85491	X-Large . . Orange	

GLOVE
\$10.95

Extended Cuff

Gray

ITEM NO.	SIZE	CUFF
E542 85501	X-Small . . Green	
E542 85511	Small White	
E542 85521	Medium . . Red	
E542 85531	Large Blue	
E542 85541	X-Large . . Orange	

White

ITEM NO.	SIZE	CUFF
E542 85551	X-Small . . Green	
E542 85561	Small White	
E542 85571	Medium . . Red	
E542 85581	Large Blue	
E542 85591	X-Large . . Orange	

GLOVE
\$11.95



Cut-Resistant Glove can be worn on knife hand, when a metal mesh glove is used. Cut-Resistant Glove can be worn on non-knife hand, when a metal mesh glove is not used.

NOTE: These gloves are sold individually, NOT as a pair.

WARNING: These gloves are cut-resistant but not cut proof or puncture proof. Do not subject to moving or highly serrated blades.

Deboning Cut-Resistant Glove

Approved for food contact with exceptional cut-resistance and added puncture protection.

- Puncture resistant material protects areas most susceptible to punctures and cuts while on the deboning line.
- Constructed of high performance fibers and wire.
- Compliant with FDA 21 CFR 177.2800, approved for direct food contact.
- Easy to launder for extended life.
- Ambidextrous, fits on either hand.



ITEM NO.	SIZE	CUFF
7419 01221	Small	Orange
7419 01231	Medium . . .	Yellow
7419 01251	Large	Light Blue
7419 01261	X-Large . .	Green

▶ 12 PER CASE.

EACH
\$19.55

Cuff edge color indicates size.



WARNING: THESE GLOVES ARE CUT-RESISTANT BUT NOT CUT PROOF OR PUNCTURE PROOF. DO NOT SUBJECT TO MOVING OR HIGHLY SERRATED BLADES.



WorkHorse® Replacement Straps

- No need for glove repairs with these easily replaceable straps.
- Straps are color-coded to indicate size.

NOTE: For use with WorkHorse® 2-inch and 3-inch extended cuff. SEE FACING PAGE.

ITEM NO.	SIZE	COLOR
B140 9015	X-Small	Gray
B140 9016	Small	White
B140 9017	Medium	Red
B140 9018	Large	Blue
B140 9019	X-Large	Green

STRAP
\$6.25



Metal Mesh Glove Tensioner

Applies a force to maintain tension and gives gloves a snug fit.

- Sanitary, stretchable polymeric mesh glove tensioner.
- Fits over the mesh glove on the back of the hand.
- Color: blue.
- One size fits most.



▶ 100 PER PACK.

ITEM NO.	PRODUCT	PACK
6235 01005	Glove Tensioner	\$82.45

NOTE: Cotton knit glove and metal mesh glove, SOLD SEPARATELY.

WorkHorse® Stainless Steel Metal Mesh Gloves with Strap Closure

The longest lasting, safest, most comfortable mesh glove — at the **LOWEST COST!**

- Heavy-gauge stainless steel rings are machine welded to give the longest lasting protection against cuts and lacerations.
- Ergonomically designed to give the best fit and dexterity.
- Metal dome snap reduces donning and doffing time.
- Available in full hand style with permanently attached straps, and extended 2-3 inch cuff designs with field-replaceable straps.
- Reversible design fits both left and right hand workers.
- Color-coded adjustable strap denotes size. • Easy to clean and sanitize.



NOTE: These gloves are sold individually, NOT as a pair.



NOTE:
We recommend wearing a cotton knit glove underneath your metal mesh.

▶ SEE PAGE 53
For Cotton Knit Gloves



Double reinforced rings at stress points to extend glove life and eliminate repairs.

2-inch and 3-inch cuff with field replaceable straps. See left page for more information.

A. Wrist-Length Cuff

ITEM NO.	SIZE	STRAP
E542 10001	X-Small, Size 6	Gray
E542 10011	Small, Size 7	White
E542 10021	Medium, Size 8	Red
E542 10031	Large, Size 9	Blue
E542 10041	X-Large, Size 10	Green
E542 06661	2X-Large, Size 11 . . .	Brown

GLOVE
\$91.25

B. 2-Inch Extended Wrist-Length Cuff

ITEM NO.	SIZE	STRAP
E542 02531	X-Small, Size 6	Gray
E542 02541	Small, Size 7	White
E542 02601	Medium, Size 8	Red
E542 02611	Large, Size 9	Blue
E542 02621	X-Large, Size 10	Green

GLOVE
\$112.35

C. 3-Inch Extended-Length Cuff

ITEM NO.	SIZE	STRAP
E542 30001	X-Small, Size 6	Gray
E542 30011	Small, Size 7	White
E542 30021	Medium, Size 8	Red
E542 30031	Large, Size 9	Blue
E542 30041	X-Large, Size 10	Green

GLOVE
\$115.45

WorkHorse® Stainless Steel Metal Mesh Gloves with Claw Hook Closure

Reversible design fits both left and right hand workers.

- The links on glove connect over and under to at least four adjacent rings, making them stronger, safer and more secure than other mesh gloves — even at the seams!
- Heavy-gauge stainless steel rings are machine welded to give the longest lasting protection against cuts and lacerations.
- Ergonomically designed to give the best fit and dexterity. • Easy to clean and sanitize.



A



Claw hook style closure.
No straps to replace.

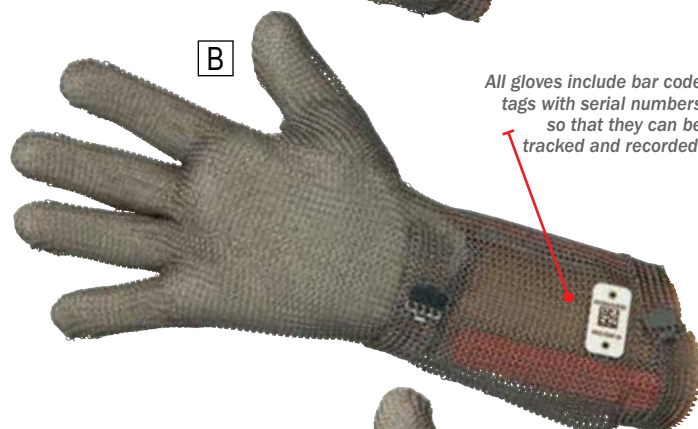

B

All gloves include bar code tags with serial numbers so that they can be tracked and recorded.

NOTE: These gloves are sold individually, NOT as a pair.



Reinforced links at the crotch of each finger.

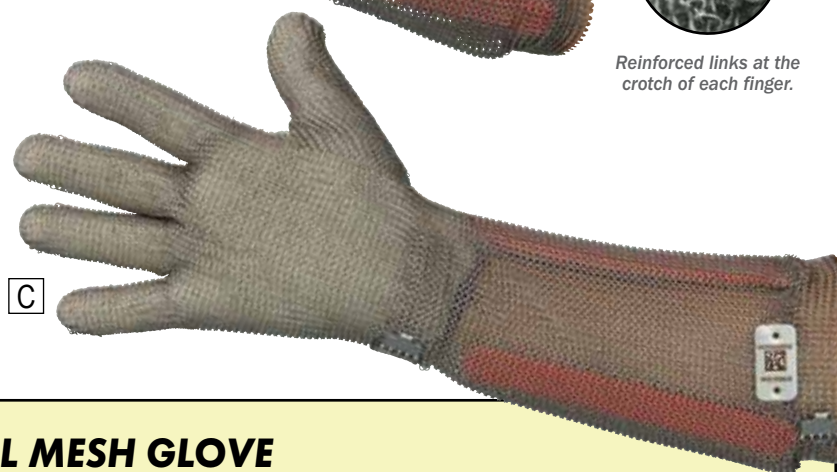

C

A. Wrist-Length Cuff

Claw Hook Closure

ITEM NO.	SIZE
E542 02631	X-Small
E542 02641	Small
E542 02701	Medium
E542 02711	Large
E542 02721	X-Large

GLOVE
\$107.05

B. 3-Inch Extended Length Cuff

Claw Hook Closure

ITEM NO.	SIZE	STIFFENER
E542 06991	2X-Small . . .	---
E542 07001	X-Small	Gray
E542 07011	Small	White
E542 07021	Medium	Red
E542 07031	Large	Blue
E542 07041	X-Large	Green
E542 07051	2X-Large . . .	Brown

GLOVE
\$140.65

C. 7-1/2-Inch Elbow Length Cuff

Claw Hook Closure

ITEM NO.	SIZE	STIFFENER
E542 07061	2X-Small . . .	---
E542 07071	X-Small	Gray
E542 07081	Small	White
E542 07091	Medium	Red
E542 07131	Large	Blue
E542 07141	X-Large	Green
E542 06981	2X-Large . . .	Brown

GLOVE
\$200.55



METAL MESH GLOVE and APRON REPAIR

Most metal mesh can be repaired.
All items are sterilized and gloves are returned with a new color-coded strap.

CALL 800-456-5624 for more information.

- 1.) Call **1-800-456-5624** for a quote.
- 2.) Ask for a sales order number.
- 3.) Mail your metal mesh product to:
Bunzl Processor Division
c/o International Services, Inc.
6129 N. 89th Circle, Omaha, NE 68134

WorkHorse® Stainless Steel Metal Mesh Gloves with Spring Closure

Durable stainless steel strap is bacteria-resistant and won't rust.



- Reversible design fits both left and right hand workers.
- Color coded stiffeners for easy size identification.
- Reversible gloves are tapered to contour to the shape of the hand for a comfortable fit.
- High tensile stainless steel ring construction is four ring joined, even at the seams to help prevent dangerous knife sticks, cuts, slashes and lacerations.
- Gloves D, E and F have a lighter, coiled spring closure instead of the standard magazine spring closure found on A, B and C - making it a more comfortable and durable spring closure option.
- Sealed strap for a clean, comfortable and secure fit, no loose clips or fasteners to snag.
- 3-inch extended and 7-1/2-inch elbow lengths have added claw hook closure at wrist.



A. Wrist-Length Cuff

ITEM NO.	SIZE	GLOVE
E542 07161	X-Small	\$108.05
E542 07171	Small	
E542 07181	Medium	
E542 07191	Large	
E542 07201	X-Large	
E542 07211	2X-Large	

B. 3-Inch Extended Length Cuff

ITEM NO.	SIZE	STIFFENER	GLOVE
E542 07231	X-Small	Gray	\$125.95
E542 07241	Small	White	
E542 07251	Medium	Red	
E542 07261	Large	Blue	
E542 07271	X-Large	Green	
E542 07281	2X-Large	Brown	

C. 7-1/2-Inch Elbow Length Cuff

ITEM NO.	SIZE	STIFFENER	GLOVE
E542 07301	X-Small	Gray	\$230.95
E542 07311	Small	White	
E542 07321	Medium	Red	
E542 07331	Large	Blue	
E542 07341	X-Large	Green	
E542 07351	2X-Large	Brown	

NOTE: These gloves are sold individually, NOT as a pair.

D. Wrist-Length Cuff

ITEM NO.	SIZE	GLOVE
E542 15581	X-Small	\$112.60
E542 15591	Small	
E542 15601	Medium	
E542 15611	Large	
E542 15621	X-Large	
E542 15631	2X-Large	

E. 3-Inch Extended Length Cuff

ITEM NO.	SIZE	STIFFENER	GLOVE
E542 15641	X-Small	Gray	\$128.70
E542 15651	Small	White	
E542 15661	Medium	Red	
E542 15671	Large	Blue	
E542 15681	X-Large	Green	
E542 15691	2X-Large	Brown	

F. 7-1/2-Inch Elbow Length Cuff

ITEM NO.	SIZE	STIFFENER	GLOVE
E542 15701	X-Small	Gray	\$247.72
E542 15711	Small	White	
E542 15721	Medium	Red	
E542 15731	Large	Blue	
E542 15741	X-Large	Green	
E542 15751	2X-Large	Brown	

Stainless Steel Mesh Aprons

- Provides wearer with frontal coverage, protects chest and abdomen from cutting tools and sharp-edge objects.
- Chest strap eliminates apron sagging for greater protection and comfort.
- Apron conforms to body contours without restricting movement.
- Adjustable nylon straps assure a perfect fit.



Mesh Safety Apron

- Elastic shoulder and waist straps keep the apron close to the user's body.
- No strapping at the top of the apron provides a cleaner garment requiring fewer repairs.
- Stainless steel construction.



Individually welded stainless steel links.

NOTE: Replacement straps available. CALL FOR MORE INFORMATION.

ITEM NO.	PRODUCT	SIZE	EACH
B140 22501	A. Split Leg Apron26" x 34"	\$484.05
B140 20011	B. Boning Apron20" x 34"	318.05
E542 08411	C. Mesh Safety Apron20" x 34"	330.65
B140 2207	Mesh Safety Apron26" x 34"	395.75

Item #'s E542 08411 and B140 2207 are F.O.B. FACTORY

WorkHorse® Stainless Steel Mesh Tunics

A safety shirt with a comfortable fit.

- Double sleeves provide extra protection.
- Stainless steel construction.
- Full-tunic has open back to help keep user cool.



Half-Tunic

ITEM NO.	SIZE
E542 07771	X-Small
E542 07781	Small
E542 07791	Medium
E542 07801	Large
E542 07811	X-Large

F.O.B. FACTORY
EACH
\$577.45



Full-Tunic

ITEM NO.	SIZE
E542 07821	X-Small
E542 07831	Small
E542 07841	Medium
E542 07851	Large
B140 43551	X-Large

F.O.B. FACTORY
EACH
\$1,421.65



WorkHorse® Titanium Mesh Tunic

Titanium tunic is 40% lighter than stainless steel while providing the same great cut resistance.

- Designed for complete upper body protection and flexibility, with coverage over the shoulders, chest, arms and thighs.
- Snap cuffs provides quick fastening.
- Non-corrosive, appropriate for wet conditions.
- Meets ANSI/ISEA Level A9 for cut resistance.
- Titanium will not harbor bacteria.
- Approved for direct food contact.



Half back and full back tunics also available. Ask your CSR for details.

ITEM NO.	SIZE	LENGTH	EACH
E542 15521	Small36"	\$2,409.10
E542 15531	Medium42"	2,409.10
E542 15541	Large48"	2,409.10
E542 15551	X-Large48"	2,409.10
E542 15561	2X-Large52"	2,654.55
E542 15571	3X-Large52"	2,654.55

Heavy-Duty, Belly Guard Style PVC Boning Aprons

- Wash in warm water using mild detergent or steam clean.
- Cut-resistant, PVC-coated both sides on cotton base. • Finished thickness: 5/32 inch.



ITEM NO.	SIZE	STRAP TYPE	STRAP LOCATION	CLOSURE	STRAP ATTACHMENT	EACH
3842 04171	18" x 14"	Self-Material	2 in. from Top	Buckle	Rivets	\$34.46
3842 04191	18" x 14"	Black Nylon	6 in. from Top	Black Snap	Rivets	31.93
5913 6685	18" x 14"	Black Nylon	2 in. from Top	Black Snap	Sewn	27.75
5913 6686	18" x 14"	Black Nylon	6 in. from Top	Black Snap	Sewn	27.75
5913 6683	23" x 18"	Self-Material	6 in. from Top	Buckle	Sewn	36.95

Heavy-Duty, Bib Style PVC Boning Apron

- Finished thickness: 5/32 inch.
- Cut-resistant, PVC-coated both sides on cotton.
- Wash in warm water using mild detergent or steam clean.
- Self-material straps attached 2 inches down from top by nickle-plated rivets.



ITEM NO.	PRODUCT	SIZE	EACH
3842 79801	Bib Style Apron	18" x 24"	\$41.95

HexArmor® Heavy-Duty Safety Apron

1/10th the weight of traditional chain mesh safety wear — dramatically reducing worker fatigue.

- Double layer of ANSI/ISEA 105-2016 Cut Level A7 cut and puncture resistant fabric provides protection against metal, glass and wood.
- Breathable, yet durable, construction keeps body cool. • Resistant to abrasions and machine washable.
- Available in 3 sizes.



► SEE PAGE 334
For HexArmor Arm Guards and Sleeves



Snap-on waist clasp.



Adjustable neck straps.



ITEM NO.	SIZE	F.O.B. FACTORY EACH
E288 22221	A. 20" x 22"	\$269.55
E288 22291	B. 20" x 30"	296.65
E288 03221	C. 24" x 30"	349.95

Arm Guards and Protective Sleeves



HexArmor arm guards and sleeves will not fall or slip down like traditional knit sleeves.

- Light-weight, yet durable construction keeps arms cool.
- Choose from arm guard or sleeves, both available in 3 sizes.
- ANSI/ISEA 105-2016 Cut Level A7.



A. 19-Inch Protective Sleeve

ITEM NO.	SIZE	F.O.B. FACTORY EACH
E288 22341	Medium	\$115.45
E288 22301	Large	
E288 22311	X-Large	

B. 9-Inch Arm Guard

ITEM NO.	SIZE	F.O.B. FACTORY EACH
E288 10091	Medium	\$51.04
E288 22321	Large	
E288 22331	X-Large	

Kevlar® Knit Sleeves

- Light-weight, non-irritating, two-ply Kevlar® stretch knit sleeves.
- Protect forearm from cuts, abrasions and minor burns.
- Available with or without thumb loops. • Machine wash or dry clean.



ITEM NO.	PRODUCT	EACH
2201 95301	14"	\$7.42
2201 02901	18"	5.44
3415 14151	14" w/Thumb Loop.	9.78

Z40 Cut-Resistant Sleeve, Blue

- Constructed from a combination of high-performance Spectra®, fiberglass, wire and polyester fibers.
- Includes alligator clip to prevent sleeves from sliding.
- Features a wide top opening for the upper arm.
- Reversible and elastic-free.
- CRF21 — approved for food contact.



ITEM NO.	PRODUCT	EACH
4164 53641	22" Cut-Resistant Sleeve w/Clip	\$32.95

Heavy-Duty Arm Guard



- Stainless steel encased in tough Spectra® fibers.
- Contains a low profile safety clip that attaches to shirt sleeve (not on forearm length guard).
- Machine washable. • Pre-washed and pre-shrunk.
- Colored cuffs make discerning sizes easy.
- CRF21 — approved for food contact.



ITEM NO.	PRODUCT	CUFF	EACH
4164 3559	10" Forearm Sleeve	Blue	\$24.15
4164 9396	20" Sleeve w/Clip.	Blue	38.45
4164 9409	22" Sleeve w/Clip.	White	40.65

21-Inch Cut-Resistant Sleeve

- Unique combination of HPPE and other high-strength fibers.
- ANSI level 5 cut resistance. • Flexible and comfortable.



▶ 6 SLEEVES PER CASE.



ITEM NO.	PRODUCT	MRF. NO.	EACH
2201 27221	Cut-Resistant Sleeve.	74-021	\$32.78

ClawCover™ 21-Inch Cut-Resistant Sleeve



- Constructed of a high-performance synthetic fiber and steel blend.
- Anti-microbial system controls bacteria and cross contamination.
- Light-weight and seamless with elastic wrist.
- Can be laundered repeatedly.



Includes alligator clip which helps prevent sleeve from sliding down.



ITEM NO.	PRODUCT	EACH
7419 13121	21" Cut-Resistant Sleeve.	\$21.95
7419 0001	Replacement Alligator Clip	3.35

Stainless Steel Mesh Sleeve

- Stainless steel rings are individually machine welded.
- Mesh is fluid so as not to restrict movement.
- The most dependable cut and puncture protection.
- Quick-release snap closure. • Easy to clean.

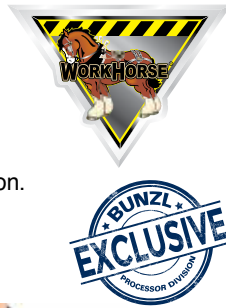

ITEM NO.	SIZE	EACH
E542 07671	X-Small	\$220.45
E542 07681	Small	
E542 07691	Medium	
E542 07701	Large	
E542 07711	X-Large	

7-1/2-Inch Plastic Arm Guards

- End turned to fit securely with mesh gloves.
- Smooth finish for easy cleaning.
- High-impact plastic.



Clear		Blue	
ITEM NO.	SIZE	ITEM NO.	SIZE
E542 05281	Small	E542 03621	Small
E542 05291	Medium	E542 03631	Medium
E542 05301	Large	E542 03641	Large
E542 05311	X-Large	E542 03651	X-Large
E542 05321	2X-Large	E542 03661	2X-Large

▶ 12 PER CASE.
EACH
\$7.95

Twin Arm Guard Sleeves

- Stainless steel mesh protects arms from wrist to shoulder.
- Adjustable harness-style support straps.
- Permits freedom of movement.
- Nylon wrist strap resists fats and oils.



ITEM NO.	SIZE	CUFF	LENGTH	CIRCUMFERENCE	F.O.B. FACTORY EACH
E542 07721	X-Small	Gray	25"	15" Bicep	\$385.25
E542 07731	Small	White	26"	16" Bicep	
E542 07741	Medium	Red	27"	17" Bicep	
E542 07751	Large	Blue	28"	18" Bicep	
E542 07761	X-Large	Green	29"	19" Bicep	

13-Inch Hog Header Arm Guard

- 13-inch hog header has a turned back upper flap.
- Made for right hand operators, so arm guard is to be worn on the left arm.
- Made from transparent, high-impact plastic.
- No straps or buckles.
- Washable.

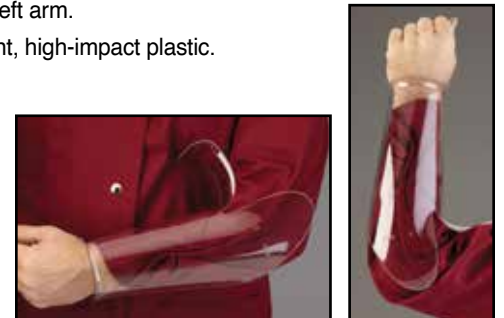

ITEM NO.	SIZE	EACH
3131 0011	Large (Fits 7.75" - 8.25" Wrist)	\$27.33
3131 0012	X-Large (Fits 8.25" - 9.25" Wrist)	27.33



Stainless Steel Foot Protectors

- For best protection, the guard should be positioned so that it rests upon the steel toe of shoe.
- Stainless steel shell with aluminum rivets.
- For use on Mens' shoes sizes 6-13.



ITEM NO.	PRODUCT	F.O.B. FACTORY PAIR
5140 2101	A. Foot Protector for Shoes w/Laces	\$49.95
5140 0107	B. Foot Protector for Shoes w/o Laces	56.81

Auto-Darkening Welding Helmet

- Auto-darkening smart filters enable welders to adapt to different working environments by digitally controlling the shade of the lens and being able to adjust for sensitivity from ambient lighting.
- Viewing area: 3-1/2 inch x 4-1/3 inch.
- Lens shade: 10. • Color: silver.



ITEM NO.	PRODUCT	EACH
C241 24631	Welding Helmet	\$281.91

Economy Welding Glove

- Cotton lining. • Color: gray.
- One size fits all.



▶ 12 PAIR PER CASE.

ITEM NO.	PRODUCT	PAIR
6292 05141	Economy Glove . . .	\$10.05

Jersey Lined Welding Glove

- Double-tanned leather with turned leather hems.
- Fully welted with reinforced thumb and palm.
- Sewn with Kevlar® thread.
- Cotton foam lining.
- One size fits all.



▶ 12 PAIR PER CASE.

ITEM NO.	PRODUCT	PAIR
6292 71501	One Size Fits All	\$14.85

Mig Tig Welding Glove

- Top grain cowhide.
- 4-1/4-inch leather gauntlet cuff.
- One size fits all.



▶ 12 PAIR PER CASE.

ITEM NO.	PRODUCT	PAIR
6292 02241	Mig Tig Glove	\$24.35

Limited Flammability Apparel

- Breathable, light-weight and cool USA treated 100% cotton.
- Tested in accordance with ASTM D6413.
- 9-ounce cotton specially treated to be flame retardant and flame resistant.
- Provides economic protection from sudden flame exposure, sparks and light molten splash.
- Washable: maintains flame resistance up to 50 home washings and 25 commercial washings up to 165 °F.



SPECIAL ORDER ITEM



Cotton Sleeves

- 2-1/2-inch heavy-duty elastic at top and wrist.
- Choose from 18 inch or 23 inch lengths.



ITEM NO.	PRODUCT	F.O.B. FACTORY EACH
3314 10791	18" Sleeve	\$15.25
3314 33701	23" Sleeve	16.45

Cotton Bib Apron

- Shoulder and waist adjustable straps.
- Anodized button snaps.

ITEM NO.	PRODUCT	F.O.B. FACTORY EACH
3314 91361	24" x 36"	\$20.57
3314 91421	24" x 42"	23.81



**SIGN UP
FOR OUR
eDEALS**

Get exclusive offers not found anywhere else!

**eDEAL SIGN-UP FORM
AVAILABLE ON OUR WEBSITE.**

www.bunzlpd.com

SHOP 24/7 bunzlpd.com

Where you can find out what's on sale, find updated product information, reviews and pricing.



STAY CONNECTED WITH US:



Need Help?
Chat With Us
Online!



CUTLERY

FIND IT FAST

INOX PRO® Cutlery	340-342, 380, 383
Mora Frosts® Knives	343-346
Victorinox Fibrox® Pro and Rosewood Handle Knives	347-350
Dexter® Wood Handle and Sani-Safe® Knives	351-354
Dexter® Prodex and Sofgrip Knives	354-355
Giesser Knives	355
Claus Antimicrobial Handle Knives	356
F. Dick Ergogrip and Mastergrip Knives	357
Granton® Edge and Color-Coded Handle Knives	358
Poultry Knives	359-360
Specialty Knives	361-363
Seafood Knives	364-365
Game Season	366-367
Knife Blocks and Roll Cases	368-369
Knife Racks, Holders, Sheaths and Scabbards	370-371
Hooks	372
Hand Tools	373-374
Corn Dog Sticks and Skewers	375
Shears	375-379
Steels	380-383
Manual Sharpeners	384-386
Electric Sharpeners	387-389
Oilstone Sharpeners	390-391
Multi-Purpose Tools	392
Utility Knives	393-395



INOX PRO® CUTLERY

Not just another knife...

a SMARTER knife

Unique serial number on every knife enables tracking

QR-Scannable and human readable serial numbers

Integrated angle indicator on hard-handled knives assists in hand steeling

Sizes and flexes are clearly marked on every blade

a MORE COMFORTABLE knife

Ergonomic handle

Flat pommel allows for inverse use

Raised logo on both sides of the handle provides improved grip

a LONGER LASTING knife

A unique and specially alloyed stainless steel

Exceptional heat resistance during sharpening operations

Enhanced corrosion resistance in day-to-day use

Improved edge retention improves service life



a BETTER knife.



INOX PRO® knives are crafted in Sweden.

Curved Boning Knives

INOX PRO®
CUTLERY



Serial numbers, QR codes, sizes and flexes are clearly marked on the blade.



Unique serial numbers on every blade in both human readable text and QR scannable formats.



Integrated angle indicator on hard MH handles.



Flat pommel and raised logo on both sides of the MH handle provide outstanding hand control.



MRS handles offer color coded inserts for easy identification.

► 10 PER BOX.

ITEM NO.	SIZE	MFR. NO.	HANDLE	BLADE	EACH	
					1-5	6+
E542 06301	A. 5"	IPCB5F-MH	MH, Black	Flex	\$24.66	\$18.24
E542 09751	5"	IPCB5F-MH	MH, Blue	Flex	24.15	18.15
E542 06251	5"	IPCB5S-MH	MH, Black	Medium	24.66	18.24
E542 06671	B. 6"	IPCB6F-MH	MH, Black	Flex	27.02	20.60
E542 09511	6"	IPCB6F-MHG	MH, Green	Flex	27.75	21.43
E542 06481	C. 6"	IPCB6S-MH	MH, Black	Medium	27.02	20.60
E542 13251	D. 6"	IPCB6FBT-MH	MH, Black	Medium	24.56	18.73
E542 08781	E. 5"	IPCB5F-MRS	MRS, Black w/Yellow	Flex	27.02	20.60
E542 08791	F. 6"	IPCB6F-MRS	MRS, Black w/Red	Flex	28.19	21.77
E542 08801	6"	IPCB6S-MRS	MRS, Black w/Blue	Medium	29.37	22.95

Breaking/Trimming Knives

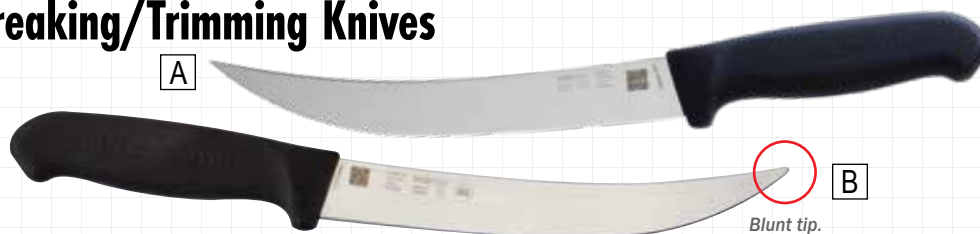

► 10 PER BOX.

ITEM NO.	SIZE	MFR. NO.	HANDLE	TIP	EACH	
					1-5	6+
E542 06451	A. 8"	IPT8-MH	MH, Black	Sharp	\$42.32	\$32.37
E542 11041	B. 8"	IPT8B-MH	MH, Black	Blunt	42.32	32.37

Skinner Knives



INOX PRO®
CUTLERY



▶ 10 PER BOX.

ITEM NO.	PRODUCT	MFR. NO.	HANDLE	EACH	
				1-5	6+
E542 06401	A. 5-1/4" Lamb Skinner	IPLS5-MH	MH, Black	\$34.08	\$25.31
E542 06851	5-1/4" Lamb Skinner	IPSKN1G	MH, Green	34.08	25.31
E542 06421	B. 6" Beef Skinner	IPCS6-MH	MH, Black	36.43	28.25

Narrow Straight Boning Knives



▶ 10 PER BOX.

ITEM NO.	SIZE	MFR. NO.	HANDLE	BLADE	EACH	
					1-5	6+
E542 06261	A. 5"	IPNSB5F-MH	MH, Black	Flex	\$25.84	\$19.42
E542 06291	B. 5"	IPNSB5S-MH	MH, Black	Medium	25.84	19.42
E542 06231	C. 6"	IPNSB6F-MH	MH, Black	Flex	27.02	20.60
E542 06171	D. 6"	IPNSB6-MFMH	MH, Black	Medium	27.02	20.60

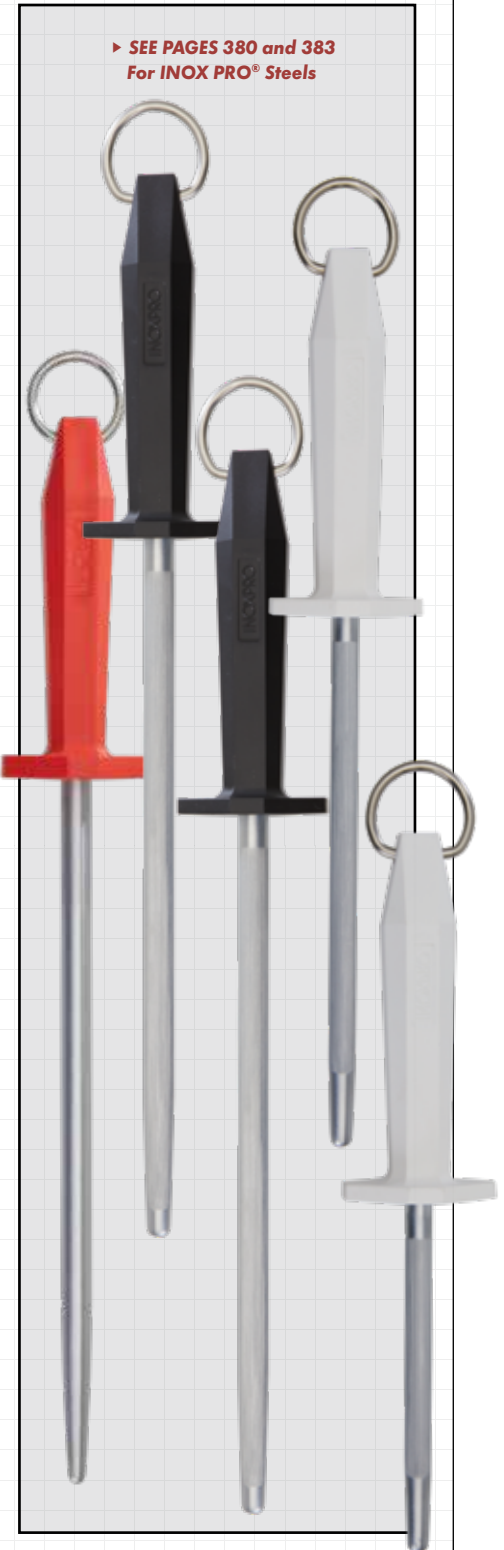



MORA FROSTS® KNIVES



YOUR FROSTS® KNIFE BECOMES A NATURAL PART OF YOUR PROFESSION AND YOUR WORKDAY.

Knives For Professional Users Since 1891

Frosts' factory is located in Mora, Sweden – just as it was a century ago. This is where they manufacture all of their knives using a combination of craftsmen skills and modern technology. Design, materials and ISO 14001 certified green methods are all constantly refined by staff who have inherited generations of professional knowledge. This can be seen in their long tradition of making top quality knives for the food industry.



The carefully selected steel enables their knives to be sharpened to an extreme edge and sharpness that lasts. The handles are ergonomically designed allowing work to be done with force, precision and in a controlled manner. This reduces the risk for work and repetitive strain injuries.

The consistent, high-quality of Mora knives enables users to receive a great deal of benefit and joy from them over a long period of time.

Hygiene and Long Life

Frosts' food industry knives are made according to the legislation and regulations on safe and hygienic handling of foods. The knives are manufactured with a seamless connection for the blade and handle core. High friction handle surface resists wear and is easy to clean and maintain.

MORAKNIL®

Quality takes no shortcuts



By appointment to H.M. the King of Sweden

FROST FLEX INDEX

Carefully selected steel enables knives to be sharpened to an extreme edge and sharpness that lasts.



ERGONOMIC HANDLES

The handles are ergonomically designed allowing work to be done with force, precision and in a controlled manner. This reduces the risk for work and repetitive strain injuries.

GRIP: POLYAMIDE HANDLE WITH MICROBLASTED STRUCTURE FOR OPTIMUM FRICTION			ERGONOMIC-GRIP: DOUBLE-MOULDED ELASTOMER RUBBER HANDLE				
G	G1	G2WG	E	E1	ER	ERS	RMH
Standard handle.	Handle with finger grips.	Handle with a large finger guard and grips.	Handle with an etched structure. Suitable for wet conditions.	Handle with an etched structure and finger grips. Suitable for wet conditions.	Handle with a ribbed pattern. Standard size.	Handle with a ribbed pattern. Small size.	Handle with a ribbed pattern and finger grips. Suitable for wet conditions.
Blades made of Swedish stainless knife steel. Hardness: 58 HRC. Easy to sharpen. Recommended for pork and lamb processing.			Blades made of Swedish stainless knife steel. Hardness: 58 HRC. Easy to sharpen. Recommended for beef processing.				



Straight Boning Knives

- High-carbon, no-stain steel gives the best service and life.
- Blade memory allows knife blade to return to its original position when it bends or twists during the cutting process.
- Ingrained pattern in the handle improves friction when knife is wet or greasy.
- Boning knives are designed for both diagonal and dagger positions – eliminating the need to shift the grip on the knife.



▶ 10 PER BOX.

ITEM NO.	SIZE	MFR. NO.	HANDLE	BLADE	EACH	
					1-9	10+
6818 10541	4"	10132	G-Grip	Medium-Flex	\$30.73	\$26.13
6818 20551	5"	10871	G-Grip	Stiff	25.87	21.50
6818 40651	5"	10891	G1-Grip	Medium-Flex	22.00	17.83
6818 40551	5"	10892	G-Grip	Medium-Flex	22.00	17.83
6818 40561	6"	10889	G-Grip	Medium-Flex	23.27	19.04
6818 40661	6"	10890	G1-Grip	Medium-Flex	23.27	19.04

Header with Finger Guard Knives

- Larger finger guards for added grip and slip protection.



▶ 10 PER BOX.

ITEM NO.	SIZE	MFR. NO.	HANDLE	EACH	
				1-9	10+
6818 00841	A. 8"	10861	G2WG-Grip	\$29.86	\$25.30
6818 40821	B. 8"	10865	G1-Grip	27.16	22.73

Beef Trimmer Knife



▶ 10 PER BOX.

ITEM NO.	SIZE	MFR. NO.	HANDLE	EACH	
				1-9	10+
6818 10821	8"	10257	E1-Grip	\$27.16	\$22.73

Poultry Knife, 3-1/2 Inch



▶ 10 PER BOX.

ITEM NO.	SIZE	MFR. NO.	EACH	
			1-9	10+
5933 90921	3-1/2"	9092PAM	\$24.03	\$21.01

Curved Boning Knives

- Swedish cold-rolled stainless steel blades.
- Ingrained pattern in the handle improves friction when knife is wet or greasy.
- Double-molded rubber grip with an etched structure, suitable for wet conditions.



▶ 10 PER BOX.

ITEM NO.	SIZE	MFR. NO.	HANDLE	BLADE	EACH	
					1-9	10+
6818 10551	A. 5"	10885	G-Grip	Stiff	\$23.25	\$19.02
6818 10521	B. 5"	10251	E-Grip	Stiff	20.68	17.45
6818 21511	C. 5"	10643	E-Grip	Medium-Flex	19.49	15.45
6818 10651	D. 5"	10902	G1-Grip	Flex	23.17	18.94
6818 00551	5"	10867	G-Grip	Flex	20.68	16.58
6818 10611	E. 6"	10253	E-Grip	Flex	22.09	17.92
6818 00661	6"	10903	G1-Grip	Flex	24.46	20.17
6818 10621	F. 6"	10254	E-Grip	Stiff	21.67	18.57
6818 00561	G. 6"	10868	G-Grip	Flex	22.00	17.83
6818 10661	H. 6"	10875	G1-Grip	Stiff	24.46	20.17
6818 10561	6"	10874	G-Grip	Stiff	23.25	19.02



Lamb Skinning Knife

- Microblasted texture on polyamide handle provides optimum friction when knife is wet or greasy.
- Stiff blade is Swedish cold-rolled stainless steel.



▶ 10 PER BOX.

ITEM NO.	SIZE	MFR. NO.	HANDLE	EACH	
				1-9	10+
6818 20651	5"	10886	G1-Grip	\$27.19	\$22.76

Beef Skinning Knife

- Stiff blade is Swedish cold-rolled stainless steel.
- Microblasted texture on polyamide handle provides optimum friction.



▶ 10 PER BOX.

ITEM NO.	SIZE	MFR. NO.	HANDLE	EACH	
				1-9	10+
6818 20661	6"	10897	G1-Grip	\$33.21	\$27.90

X-traFlex Curved Knives

- Ingrained pattern in the handle improves friction when knife is wet or greasy.
- Hardness and flexibility have been incorporated into the finest quality Swedish high-carbon, no-stain steel to give the best possible service and life.
- ER-grip: Double-molded rubber handle with ribs, good for wet conditions. Also comes in a small ERS style and RMH style.



Boning knives are designed for both diagonal and dagger positions – eliminating the need to shift the grip on the knife.



▶ 10 PER BOX.

ITEM NO.	SIZE	MFR. NO.	HANDLE	EACH	
				1-9	10+
6818 12601	A. 6"	10255	ER-Grip	\$23.30	\$19.06
6818 11601	B. 6"	10256	ERS-Grip	23.27	18.94
5933 00321	C. 6"	13924	RMH	17.33	11.59

Sticking Knife

- Swedish high-carbon, no-stain steel to gives the best service and life.
- White, polyamide microblasted custom handle for optimum protection.
- Designed for both diagonal and dagger positions – sabre grip helps avoid slipping.
- Double-edged blade.



▶ 10 PER BOX.

ITEM NO.	PRODUCT	MFR. NO.	EACH	
			1-9	10+
6818 30451	A. 6-3/4" Stiff	1-0144	\$60.43	\$57.40
6818 30431	B. 8" Stiff	14211	62.43	59.40

SHOP 24/7
bunzlpd.com



Need Help?
Chat With Us
Online!

STAY CONNECTED WITH US:





INTRODUCING FROSTS® RMH ERGONOMIC HANDLE

- Blades are manufactured from Swedish steel. • Individually serial numbered and trackable by QR code.
- Slip resistant polyamide handle with microblasted texture is also resistant to fats and oils.
- Available with blunted safety tip or standard pointed tips. • Boning knives are available in different flex grades.

Breaking/Trimming Knives



▶ 10 PER BOX.

ITEM NO.	SIZE	MFR. NO.	HANDLE	BLADE	EACH	
					1-9	10+
6818 00011	A. 8"	14133	T8BT-RMH	Stiff	\$26.40	\$22.40
6818 00021	B. 8"	14134	T8BT-RMH	Stiff	26.40	22.40

Straight Narrow Boning Knives

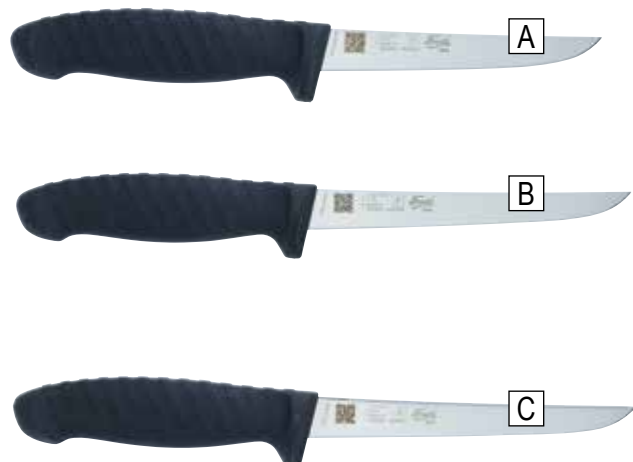

▶ 10 PER BOX.

ITEM NO.	SIZE	MFR. NO.	HANDLE	BLADE	EACH	
					1-9	10+
6818 00111	A. 5"	14187	SB5MF-RMH	Med Flex	26.40	22.40
6818 00121	B. 6"	14186	SB5BT F-RMH	Flex	26.40	22.40
6818 00131	C. 6"	14188	SB6F-RMH	Flex	26.40	22.40
6818 00141	6"	14189	SB6MF-RMH	Med Flex	26.40	22.40
6818 00151	6"	14190	TSB6F-RMH	Flex	26.40	22.40

Curved Boning Knives



▶ 10 PER BOX.

ITEM NO.	SIZE	MFR. NO.	HANDLE	BLADE	EACH	
					1-9	10+
6818 00071	A. 5"	14175	CB5S-RMH	Stiff	\$26.40	\$22.40
6818 00051	B. 5"	14169	CB5BT F-RMH	Flex	26.40	22.40
6818 00081	C. 5"	14178	CB5BT S-RMH	Stiff	26.40	22.40
6818 00041	D. 6"	14174	CB6F-RMH	Flex	26.40	22.40
6818 00091	E. 6"	14176	CB6S-RMH	Stiff	26.40	22.40
6818 00101	F. 6"	14164	CB6BT S-RMH	Stiff	26.40	22.40
6818 00061	G. 6"	14177	CB6BT F-RMH	Flex	26.40	22.40

Fibrox® Pro Handle Knives

- Premium stainless steel blade.
- Non-slip Fibrox® Pro handle.
- Safety guard.



VICTORINOX
SWISS ARMY

Superflex Boning Knife



▶ 6 PER BOX.

ITEM NO.	PRODUCT	MFR. NO.	EACH	
			1-5	6+
3367 00631	6" Superflex	5.6663.15	\$28.74	\$25.04

Blunt Tip Blade Knife

Blunt tip is safer to use.

- For extra protection, blunt tip won't penetrate into metal mesh gloves.



▶ SEE PAGES 341-342
For INOX Pro Cutlery

▶ 6 PER BOX.

ITEM NO.	PRODUCT	MFR. NO.	EACH	
			1-5	6+
3367 03151	6" Semi-Stiff	5.6603.15RS	\$29.00	\$24.52

Breaking Knives



▶ 6 PER BOX.

ITEM NO.	PRODUCT	MFR. NO.	EACH	
			1-5	6+
3367 05371	8" Curved	5.7203.20	\$43.64	\$38.38
3367 05381	10" Curved	5.7203.25	50.10	43.52

Curved Skinning Knives



▶ 6 PER BOX.

ITEM NO.	PRODUCT	MFR. NO.	EACH	
			1-5	6+
3367 05351	A. 5" Curved	5.7803.12	\$34.82	\$29.14
3367 02311	B. 6" Yellow	5.7808.15	37.90	32.08
3367 05361	6" Curved	5.7803.15	37.90	32.08

Flank Knives



▶ 6 PER BOX.

ITEM NO.	PRODUCT	MFR. NO.	EACH	
			1-5	6+
3367 41511	7" Flank Knife, Stiff	5.5503.18	\$36.30	\$27.67
3367 05341	8" Flank Knife, Stiff	5.5503.20	35.84	30.82

Lamb Skinner, 5 Inch



▶ 6 PER BOX.

ITEM NO.	HANDLE	MFR. NO.	EACH	
			1-5	6+
3367 05321	Black	5.7903.12	\$34.60	\$29.56
3367 04121	Green	5.7904.12	34.60	29.56
3367 15321	Yellow	5.7908.12	34.60	29.56
3367 00491	White	5.7907.12	34.60	29.56

Fillet Knife



▶ 6 PER BOX.

ITEM NO.	PRODUCT	MFR. NO.	EACH	
			1-5	6+
3367 07141	6" Straight	5.2803.15	\$26.96	\$21.75

VICTORINOX FIBROX® PRO HANDLE KNIVES

Fibrox® Pro Handle Knives

• Premium stainless steel blade. • Non-slip Fibrox® Pro handle. • Safety guard.



VICTORINOX
SWISS ARMY

Slicer/Carver



▶ 6 PER BOX.

ITEM NO.	PRODUCT	MFR. NO.	EACH	
			1-5	6+
3367 15411	A. 12" Slicer	5.4503.30	\$55.66	\$43.08
3367 40641	B. 14" Slicer, Granton Edge	5.4723.36	106.10	84.84

Curved Cimeter Knives



▶ 6 PER BOX.

ITEM NO.	PRODUCT	HANDLE	MFR. NO.	EACH	
				1-5	6+
3367 05391	A. 10"	Black	5.7303.25	\$53.92	\$46.15
3367 04251	10"	Red	5.7301.25	56.52	45.34
3367 04751	10"	Yellow	5.7308.25	56.52	45.34
3367 16301	12"	Black	5.7303.31	72.34	64.94
3367 15341	14"	Black	5.7303.36	95.66	75.88
3367 06341	B. 10", Granton Edge	Black	5.7323.25	112.18	88.75
3367 06331	12", Granton Edge	Black	5.7323.31	127.84	102.27

Narrow Boning Knives



▶ 6 PER BOX.

ITEM NO.	PRODUCT	MFR. NO.	EACH	
			1-5	6+
3367 00271	5" Narrow Semi-Flex	5.6230.12	\$26.22	\$21.85
3367 05101	5" Narrow Stiff	5.6403.12	25.78	21.48
3367 05121	5" Narrow Flex	5.6413.12	25.58	21.32
3367 00451	6" Narrow Semi-Flex	5.6203.15	27.00	24.31
3367 00041	6" Narrow Stiff	5.6403.15	26.62	23.15
3367 00031	6" Narrow Flex	5.6413.15	25.82	21.52
3367 06131	8" Straight Flex	5.3763.20	33.22	28.40

Wide Boning Knives



▶ 6 PER BOX.

ITEM NO.	PRODUCT	MFR. NO.	EACH	
			1-5	6+
3367 06141	5" Wide Stiff	5.6103.12	\$25.92	\$23.15
3367 00071	6" Wide Stiff	5.6103.15	27.56	22.84
3367 00081	6" Wide Curved Stiff	5.6503.15	27.56	22.84
3367 00191	6" Wide Heavy Stiff	5.6003.15	27.56	22.84

Curved Boning Knives



▶ 6 PER BOX.

ITEM NO.	PRODUCT	HANDLE	MFR. NO.	EACH	
				1-5	6+
3367 05141	A. 5" Semi-Stiff	Black	5.6603.12	\$26.22	\$21.89
3367 00051	5" Flex	Black	5.6613.12	26.22	21.89
3367 00141	6" Semi-Stiff	Black	5.6603.15	27.32	23.36
3367 01661	5" Semi-Stiff	Red	5.6601.12	27.84	23.79
3367 04201	6" Semi-Stiff	Red	5.6601.15	26.92	23.36
3367 04701	6" Semi-Stiff	Yellow	5.6608.15	26.92	23.36
3367 0450	6" Semi-Stiff	Blue	5.6602.15	26.92	23.36
3367 94151	6" Flex	Black	5.6613.15	27.62	23.89
3367 01681	6" Flex	Yellow	5.6618.15	27.62	23.89
3367 26101	B. 6" Granton Edge	Black	5.6523.15	35.60	31.87

FREE GROUND SHIPPING*

when you place an order for \$500 or more from THIS BUYERS GUIDE!

*FREE SHIPPING does NOT include UPS Next Day Air, UPS 2nd Day or UPS 3rd Day Select. Certain items may not qualify. This offer is good only on orders shipped UPS Ground in the 48 contiguous states. Based on dimensional weight, we will determine the most efficient means of shipment, either UPS or LTL. Products may ship by truckline.

Fibrox® Pro Handle Knives

• Premium stainless steel blade. • Non-slip Fibrox® Pro handle. • Safety guard.



VICTORINOX
SWISS ARMY

Chef Knives



▶ 6 PER BOX.

ITEM NO.	PRODUCT	HANDLE	MFR. NO.	EACH	
				1-5	6+
3367 04211	A. 8" Straight Slicer . . . Red	Red	5.2061.20	\$50.44	\$41.50
3367 04511	8" Straight Slicer . . . Blue	Blue	5.2062.20	50.44	41.50
3367 04711	8" Straight Slicer . . . Yellow	Yellow	5.2068.20	50.44	41.50
3367 40521	8" X-Wide Slicer . . . Black	Black	5.2063.20	50.66	42.95
3367 40511	B. 10" Straight Slicer . . . Black	Black	5.2003.25	54.78	43.82
3367 04241	10" Straight Slicer . . . Red	Red	5.2001.25	54.78	43.82
3367 04541	10" Straight Slicer . . . Blue	Blue	5.2002.25	54.78	43.82
3367 04741	10" Straight Slicer . . . Yellow	Yellow	5.2008.25	54.78	43.82
3367 15221	12" Straight Slicer . . . Black	Black	5.2003.31	70.44	54.03

Bread Knives

• Premium high-carbon stainless steel blade with wavy edge.



▶ 6 PER BOX.

ITEM NO.	PRODUCT	HANDLE	MFR. NO.	EACH	
				1-5	6+
3367 05491	A. 8" Wavy Black	Black	5.2533.21..	\$37.38	\$30.19
3367 0547	B. 10-1/4" Wavy . . . Black	Black	5.2933.26..	50.44	40.90
3367 04531	10-1/4" Wavy . . . Blue	Blue	5.2932.26..	50.44	40.90
3367 04831	10-1/4" Wavy . . . Green	Green	5.2934.26..	50.44	40.90

Boning Knife, 3-3/4 Inch



▶ 6 PER BOX.

ITEM NO.	HANDLE	MFR. NO.	EACH	
			1-5	6+
3367 03131	Black	5.5903.09S	\$14.95	\$13.95
3367 03171	Blue	5.5902.09S	14.95	13.95
3367 03141	Orange	5.5909.09S	14.95	13.95

Slant Point Boning Knife, 3-1/4 Inch



▶ 6 PER BOX.

ITEM NO.	HANDLE	MFR. NO.	EACH	
			1-5	6+
3367 02841	Black	5.5903.08S	\$13.62	\$11.62
3367 03161	Blue	5.5902.08S	13.62	11.62
3367 03001	Orange	5.5909.08S	13.62	11.62

Polypropylene Handle Paring Knives

"Little Vicky" Paring Knives



Paring Knives

• High carbon stainless steel.



▶ 12 PER BOX.

ITEM NO.	PRODUCT	HANDLE	MFR. NO.	EACH	
				1-11	12+
3367 03031	A. 3-1/4" Wavy . . . Red	Red6.7631	\$6.96	\$5.96
3367 61151	B. 3-1/4" Straight . . Pink	Pink6.7606.L115..	6.34	4.98
3367 03051	C.3-1/4" Straight . . Black	Black6.7603	6.96	5.96
3367 03081	4" Straight Black	Black6.7703	7.84	6.84
3367 03071	D. 3-1/4" Wavy . . . Black	Black6.7633	7.84	6.84

VICTORINOX FIBROX® PRO AND POLYPROPYLENE HANDLE KNIVES

Rosewood Handle Knives

- Premium stainless steel blade. • Quality Rosewood handle. • Safety guard. • Nickel-silver rivets.



VICTORINOX
SWISS ARMY

Narrow Boning Knife



▶ 6 PER BOX.

EACH				
ITEM NO.	PRODUCT	MFR. NO.	1-5	6+
3367 40131	6" Stiff	5.6406.15	\$53.62	\$36.60

Wide Boning Knives



▶ 6 PER BOX.

EACH				
ITEM NO.	PRODUCT	MFR. NO.	1-5	6+
3367 00101	5" Stiff	5.6106.12	\$41.74	\$31.75
3367 01131	6" Stiff	5.6106.15	41.74	31.75
3367 40561	6" Stiff Heavy	5.6006.15	41.74	31.75
3367 00781	7" Stiff	5.6416.12	46.98	38.93

Curved Boning Knives



▶ 6 PER BOX.

EACH				
ITEM NO.	PRODUCT	MFR. NO.	1-5	6+
3367 01161	5" Semi-Stiff	5.6606.12	\$39.64	\$35.54
3367 00901	5" Flex	5.6616.12	43.26	32.69
3367 01101	6" Semi-Stiff	5.6606.15	40.04	35.96
3367 82131	6" Flex	5.6616.15	44.36	35.55
3367 01181	6" Wide Semi-Stiff	5.6500.15	46.10	36.03

Paring Knife



▶ 12 PER BOX.

EACH				
ITEM NO.	PRODUCT	MFR. NO.	1-11	12+
3367 41001	3.25" Long Handle	5.3000	\$20.32	\$16.67

Straight Chef's Knife



▶ 6 PER BOX.

EACH				
ITEM NO.	PRODUCT	MFR. NO.	1-5	6+
3367 40061	10"	5.2000.25	\$73.98	\$60.07

Cimeter Knives



▶ 6 PER BOX.

EACH				
ITEM NO.	PRODUCT	MFR. NO.	1-5	6+
3367 00581	10" Curved	5.7300.25	\$80.02	\$63.35
3367 01331	12" Curved	5.7300.31	104.36	84.18
3367 00161	14" Curved	5.7300.36	133.94	107.37

Breaking Knives



▶ 6 PER BOX.

EACH				
ITEM NO.	PRODUCT	MFR. NO.	1-5	6+
3367 82001	8"	5.7200.20	\$62.62	\$49.49
3367 01301	10"	5.7200.25	77.40	62.57



NEED ASSISTANCE?

Our experienced customer service representatives are available to answer your questions, find the products you are looking for, check product availability, as well as take your order.

800-456-5624



DEXTER® WOOD HANDLE KNIVES

Traditional Wood Handle Knives

- High-carbon steel blade*.
- Unique edge geometry for long lasting, easily restored performance.
- Hand honed to the ultimate edge.
- Formed handle for comfort and functionality.
- Polished beechwood handles.
- Large brass compression rivets.

Butcher Knife



▶ 6 PER BOX.

ITEM NO.	PRODUCT	MFR. NO.	EACH	
			1-5	6+
5816 46911	8" Butcher Knife.....	012G-8BU	\$29.84	\$21.68

Skinner Knife



▶ 6 PER BOX.

ITEM NO.	PRODUCT	MFR. NO.	EACH	
			1-5	6+
5816 63211	6" Skinner.....	012G-6.....	\$26.13	\$19.13

Narrow Stiff Boning Knife



▶ 6 PER BOX.

ITEM NO.	PRODUCT	MFR. NO.	EACH	
			1-5	6+
5816 26611	6" Narrow.....	1012G-6.....	\$21.15	\$15.32

Lamb Skinner Knife



▶ 6 PER BOX.

ITEM NO.	PRODUCT	MFR. NO.	EACH	
			1-5	6+
5816 63711	5-1/4" Skinner	L012G-5.25	\$26.13	\$19.13

Round Point Fish Knife



▶ 6 PER BOX.

ITEM NO.	PRODUCT	MFR. NO.	EACH	
			1-5	6+
5816 10301	4-1/2" Round Point.	1674.5	\$19.88	\$15.21

Sticker Knife



▶ 6 PER BOX.

ITEM NO.	PRODUCT	MFR. NO.	EACH	
			1-5	6+
5816 50071	6" Sticker	1076CG	\$38.64	\$26.98

"Dont Tread On Me" Wood Handle Knives

Low-cost beechwood handle, with full tang razor-sharp blades secured with indestructible rivets.



Narrow Boning Knife, 6 inch Stiff



▶ 6 PER BOX.

ITEM NO.	MFR. NO.	EACH	
		1-5	6+
5816 13551	22345-6N.....	\$17.44	\$12.77

Lamb Skinner Knife, 5-1/4 inch



▶ 6 PER BOX.

ITEM NO.	MFR. NO.	EACH	
		1-5	6+
5816 63751	41842-5.25	\$19.88	\$14.05

Curved Boning Knives, 6 inch Semi-Stiff



▶ 6 PER BOX.

ITEM NO.	MFR. NO.	EACH	
		1-5	6+
5816 14451	12741-6F.....	\$19.88	\$15.21

HANDLE GUIDE



EP	PDM	PDC	PDB	PDU	PDS	SOFGRIP® (SG & P)	SANI-SAFE® (S)
Light-weight and ergonomically designed specifically for use with poultry. Slip-resistant with finger guard for protection.	Reverse-hook finger guard for protection. Textured, slip resistant, non-porous handle eliminates fat barrier between handle and hand.	Soft, anti-slip, semi-ribbed and etched structure. Finger pad on the top of the handle for additional control. Color coded to indicate flex.	Soft handle, ribbed spiral pattern, slip resistant.	Soft handle, finger guard for protection, slip resistant. Color coded to indicate flex.	Soft, high-definition ribbed handle texture and finger guard for protection.	Soft, non-slip, comfort-first handle designed to reduce potential stress on the wrist.	Durable handle with textured, slip-resistant, easy-to-clean polypropylene that's made of 100% recycled material. Includes finger guard.



Scannable data matrix etches are available on most Dexter processing items for knife accountability.

Dexter® Sani-Safe® Handle Knives

Stain-free, proprietary DEXSTEEL blades with textured, easy to clean, polypropylene handles.



Vent Knife



▶ 12 PER BOX.

ITEM NO.	PRODUCT	MFR. NO.	EACH	
			1-11	12+
5816 00871	3-1/2"	STP153HG.	\$13.73	\$10.23

Boning/Utility Knives



▶ 12 PER BOX.

ITEM NO.	PRODUCT	MFR. NO.	EACH	
			1-11	12+
5816 00881	A. 4"	STP154HG.	\$13.62	\$10.12
5816 00891	B. 5"	STP155WHG	17.44	12.77

* Please note, these knives have High-Carbon Steel Blades that can rust and stain. Please make sure to clean your high-carbon steel blade by hand washing and drying. Coat the blade with mineral oil and store in a dry place to keep it from rusting/staining. Fine steel wool can also be used when needed.

Sharp Point Boning Knife



▶ 12 PER BOX.

ITEM NO.	PRODUCT	MFR. NO.	EACH	
			1-11	12+
5816 00901	6"	STP156HG.	\$19.88	\$14.05

Header Knife, High Carbon Steel*



▶ 6 PER BOX.

ITEM NO.	PRODUCT	MFR. NO.	EACH	
			1-5	6+
5816 40891	7-1/2" Stiff	114H-7.5	\$27.40	\$20.41

Clip Point Boning Knife



▶ 12 PER BOX.

ITEM NO.	PRODUCT	MFR. NO.	EACH	
			1-11	12+
5816 00861	3-1/4"	STP152HG.	\$13.73	\$11.40

Dexter® Sani-Safe® Handle Knives



Narrow Boning Knives



▶ 6 PER BOX.

ITEM NO.	PRODUCT	MFR. NO.	EACH	
			1-5	6+
5816 15131	5" Narrow Flex	S135F	\$24.86	\$17.86
5816 00081	5" Narrow Stiff	S135N	24.86	17.86
5816 15431	6" Narrow Flex	S136F	26.13	19.13
5816 15631	6" Narrow Stiff	S136N	26.13	19.13

Curved Narrow Boning Knives



▶ 6 PER BOX.

ITEM NO.	PRODUCT	HANDLE	MFR. NO.	EACH	
				1-5	6+
5816 14631	5"	White	S131-5	\$24.86	\$17.86
5816 00091	5" Flex	White	S131F-5	24.86	17.86
5816 14931	6"	White	S131-6	24.86	17.86
5816 13101	6" Flex	White	S131F-6	24.86	17.86
5816 00791	6" Stiff	Black	ST131S-6	24.86	17.86
5816 00801	6" Flex	Black	ST131F-6	24.86	17.86

Wide Boning Knives



▶ 6 PER BOX.

ITEM NO.	PRODUCT	HANDLE	MFR. NO.	EACH	
				1-5	6+
5816 00071	A. 6" Stiff	White	S136	\$26.13	\$19.13
5816 00831	B. 6" Stiff	Black	ST136	21.15	15.32
5816 63731	C. 6" Stiff Poultry	Black	STP136	19.88	14.05

Breaking Knives



▶ 6 PER BOX.

ITEM NO.	PRODUCT	MFR. NO.	EACH	
			1-5	6+
5816 55231	8"	S132N-8	\$37.37	\$26.87
5816 54931	10"	S132N-10	44.89	32.07

Paring Knife



▶ 12 PER BOX.

ITEM NO.	PRODUCT	MFR. NO.	EACH	
			1-11	12+
5816 53031	3-1/4"	S104	\$8.21	\$5.67

Bread Slicer



▶ 6 PER BOX.

ITEM NO.	PRODUCT	MFR. NO.	EACH	
			1-5	6+
5816 81731	10" Scalloped	S147-10SC	\$34.93	\$24.43

Fillet Knives



▶ 6 PER BOX.

ITEM NO.	PRODUCT	MFR. NO.	EACH	
			1-5	6+
5816 0034	7" Fillet	S133-7	\$28.67	\$20.51
5816 10171	8" Narrow Stiff	S133-8	31.11	21.78
5816 10191	8" Wide Stiff	S138	32.38	23.06

Cooks Knives



▶ 6 PER BOX.

ITEM NO.	PRODUCT	MFR. NO.	EACH	
			1-5	6+
5816 24431	8"	S145-08	\$38.85	\$26.74
5816 03021	10"	S145-10	42.88	29.52
5816 24731	12"	S145-12	53.58	38.43

Beef Skinning Knife



▶ 6 PER BOX.

ITEM NO.	PRODUCT	MFR. NO.	EACH	
			1-5	6+
5816 00381	6"	SB12-6	\$32.38	\$23.06

DEXTER® SANI-SAFE® HANDLE KNIVES

Dexter® Sani-Safe® Handle Knives

Cimeter/Steak Knives



▶ 6 PER BOX.

ITEM NO.	PRODUCT	MFR. NO.	EACH	
			1-5	6+
5816 10501	10" Stiff	S132-10	\$46.06	\$33.23
5816 13781	12" Stiff	S132-12	56.13	39.80

Lamb Skinning Knives



▶ 6 PER BOX.

ITEM NO.	PRODUCT	HANDLE	MFR. NO.	EACH	
				1-5	6+
5816 61431	5-1/4"	White	SL12	\$31.11	\$21.78

Butcher Knives



▶ 6 PER BOX.

ITEM NO.	PRODUCT	MFR. NO.	EACH	
			1-5	6+
5816 00411	6"	S112-6	\$32.38	\$23.06
5816 11281	8"	S112-8	37.37	26.87
5816 00061	10"	S112-10	43.09	29.10
5816 03001	12"	S112-12	57.29	39.80



SIGN UP FOR OUR eDEALS

Get exclusive offers not
found anywhere else!

eDEAL SIGN-UP
FORM AVAILABLE
ON OUR WEBSITE.

www.bunzlpd.com

Dexter® Prodex Knives

- Durable handles offer a unique texture and pronounced finger guard for a safe, anti-slip grip.
- Handle shape, materials and reverse hook finger guard virtually eliminate injuries due to slippages while remaining comfortable in all gripping positions.
- Anti-slip material eliminates fat barrier between hand and handle, thus reducing gripping pressure and fatigue.

Curved Semi-Flex Boning Knives



▶ 12 PER BOX.

ITEM NO.	PRODUCT	MFR. NO.	EACH	
			1-11	12+
5816 70031	A. 5"	PDM131-5	\$21.15	\$17.65
5816 72431	B. 5" Safety Tip	PDM131-5ST	23.80	21.68
5816 70231	C. 6"	PDM131-6	22.42	20.09
5816 72831	D. 6" Safety Tip	PDM131-6ST	23.80	21.68

Lamb Skinner Knife



▶ 12 PER BOX.

ITEM NO.	PRODUCT	MFR. NO.	EACH	
			1-11	12+
5816 03311	5-1/4"	PDM12-5.25	\$29.84	\$25.18

Wide Stiff Boning Knife



▶ 6 PER BOX.

ITEM NO.	PRODUCT	MFR. NO.	EACH	
			1-5	6+
5816 69831	6"	PDM136	\$22.42	\$18.92

White SofGrip™ Knives

- Ergonomically designed pliable SofGrip™ handle reduces hand stress and wrist fatigue.
- Proprietary DexSteel blade with an individually ground and honed edge.



Roast Slicer Knife



▶ 6 PER BOX.

ITEM NO.	PRODUCT	MFR. NO.	EACH	
			1-5	6+
5816 01091	12" Duo-Edge	SG140-12GE	\$56.13	\$39.80

Cimeter Knife



▶ 6 PER BOX.

ITEM NO.	PRODUCT	MFR. NO.	EACH	
			1-5	6+
5816 49841	10"	SG132-10	\$48.60	\$34.61

Beef Skinning Knives



▶ 6 PER BOX.

ITEM NO.	PRODUCT	MFR. NO.	EACH	
			1-5	6+
5816 65731	6", High-Carbon Steel Blade*	12-6MO	\$26.13	\$19.13
5816 65531	6", Stainless Steel Blade	S126MO	29.84	21.68

*Please note, this knife has a High-Carbon Steel Blade, it can rust and stain. Please make sure to clean your high carbon steel blade by hand washing and drying. Coat the blade with mineral oil and store in a dry place to keep it from rusting/staining. Fine steel wool can also be used when needed.

Straight Boning Knives



▶ 6 PER BOX.

ITEM NO.	PRODUCT	MFR. NO.	EACH	
			1-5	6+
5816 15931	A. 6" Stiff	S115-6MO	\$27.40	\$19.24
5816 0103	B. 6" Wide	SG136	26.13	19.13

Curved Boning Knives



▶ 6 PER BOX.

ITEM NO.	PRODUCT	MFR. NO.	EACH	
			1-5	6+
5816 16141	A. 6" Stiff	S116-6MO	\$27.40	\$19.24
5816 16631	B. 6" Flexible	S116F-MO	27.40	19.24

PrimeLine

- Made specifically for industrial butchering environments. • Granton® style blade edge.
- Soft, ergonomic handle grip is made from slip proof plastic with antimicrobial protection.



Butcher Knife



▶ 10 PER BOX.

ITEM NO.	PRODUCT	MFR. NO.	EACH	
			1-9	10+
3363 12151	9-3/4"	6005WWL24	\$53.13	\$50.46

Stiff Boning Knife



▶ 10 PER BOX.

ITEM NO.	PRODUCT	MFR. NO.	EACH	
			1-9	10+
3363 15161	6"	12251WWL15	\$37.47	\$35.33

Breaking Knives



▶ 10 PER BOX.

ITEM NO.	PRODUCT	MFR. NO.	EACH	
			1-9	10+
3363 05221	A. 8"	2005WWL20	\$45.73	\$44.39
3363 05231	B. 10"	2005WWL25	55.07	53.74

DEXTER SOFG RIP AND GIESSER PRIMELINE KNIVES

Titanium Bonded® Knives with Antimicrobial Ergonomic Handles

- Titanium Bonded® blades make these knives 3 times harder than stainless steel.
- Corrosion-resistant. • Precision ground blades. • Oversized backbone for strength and durability.
- Ergonomic, non-slip grip handles contain an antimicrobial agent to inhibit the growth of bacterial stains and odors.



Boning Knife, 5 Inch



▶ 3 PER BOX.

ITEM NO.	PRODUCT	MFR. NO.	EACH	
			1-2	3+
2644 84131	5"	18413.	\$19.28	\$18.03

Curved Paring Knife, 2-1/2 Inch



▶ 3 PER BOX.

ITEM NO.	PRODUCT	MFR. NO.	EACH	
			1-2	3+
2644 84141	2-1/2"	18414.	\$10.44	\$9.23

Slicing Knife, 6-1/2 Inch



▶ 3 PER BOX.

ITEM NO.	PRODUCT	MFR. NO.	EACH	
			1-2	3+
2644 84161	6-1/2"	18416.	\$16.78	\$15.63

Straight Paring Knife, 2-1/2 Inch



▶ 3 PER BOX.

ITEM NO.	PRODUCT	MFR. NO.	EACH	
			1-2	3+
2644 84281	2-1/2"	18428.	\$10.44	\$9.23

Santoku Knife, 5 Inch



▶ 6 PER BOX.

ITEM NO.	PRODUCT	MFR. NO.	EACH	
			1-5	6+
2644 87441	5"	18744.	\$17.92	\$16.66

Fillet Knife, 6 Inch



▶ 3 PER BOX.

ITEM NO.	PRODUCT	MFR. NO.	EACH	
			1-2	3+
2644 84171	6"	18417.	\$19.28	\$18.03

Chef Knives, 6, 8 and 10 Inch



▶ 3 PER BOX.

ITEM NO.	PRODUCT	MFR. NO.	EACH	
			1-2	3+
2644 84121	6"	18412.	\$24.84	\$23.63
2644 87461	8"	18746.	26.30	25.05

Butcher Knife, 10 Inch



▶ 6 PER BOX.

ITEM NO.	PRODUCT	MFR. NO.	EACH	
			1-5	6+
2644 87491	10"	18749.	\$30.39	\$29.19

FREE GROUND SHIPPING*

when you place an order for \$500 or more from THIS BUYERS GUIDE!

*FREE SHIPPING does NOT include UPS Next Day Air, UPS 2nd Day or UPS 3rd Day Select. Certain items may not qualify.

This offer is good only on orders shipped UPS Ground in the 48 contiguous states. Based on dimensional weight, we will determine the most efficient means of shipment, either UPS or LTL. Products may ship by truckline.

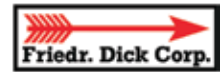

F. Dick Ergogrip Knives

- Superior slip-resistant handles.
- Designed specifically to reduce arm and hand fatigue.
- Extra-wide thumb rest and elongated finger guard.

Straight Boning Knives



▶ 6 PER BOX.

ITEM NO.	PRODUCT	MFR. NO.	EACH	
			1-5	6+
3186 90131	5" Narrow Stiff	8299013	\$17.08	\$14.81
3186 90151	6" Narrow Stiff	8299015	18.98	16.45
3186 80131	5" Narrow Flex	8298013	17.08	14.81
3186 80151	6" Narrow Flex	8298015	18.98	16.45
3186 93131	5" Wide Stiff	8299313	17.08	14.81
3186 99361	6" Wide Stiff	8299315	20.11	18.59

Breaking Knives



▶ 6 PER BOX.

ITEM NO.	PRODUCT	MFR. NO.	EACH	
			1-5	6+
3186 42581	8"	8242521	\$28.71	\$24.88
3186 25261	10"	8242526	37.31	32.09

Cimeter Knives



▶ 6 PER BOX.

ITEM NO.	PRODUCT	MFR. NO.	EACH	
			1-5	6+
3186 53261	10"	8225326	\$40.92	\$35.90
3186 53121	12"	8225330	47.61	41.26

Curved Boning Knives



▶ 6 PER BOX.

ITEM NO.	PRODUCT	MFR. NO.	EACH	
			1-5	6+
3186 91131	5" Stiff	5299113	\$17.08	\$14.81
3186 82131	5" Semi-Flex	8298213	18.98	16.45
3186 91151	6" Stiff	8299115	18.98	16.45
3186 81131	5" Flexible	8298113	18.98	16.45
3186 81151	6" Flexible	8298115	18.98	16.45

Butcher Knives



▶ 6 PER BOX.

ITEM NO.	PRODUCT	MFR. NO.	EACH	
			1-5	6+
3186 85101	10"	8238526	\$39.11	\$33.89
3186 85121	12"	8238530	47.36	41.03

Skinning Knife



▶ 6 PER BOX.

ITEM NO.	PRODUCT	MFR. NO.	EACH	
			1-5	6+
3186 26461	6"	8226415	\$33.20	\$25.77

F. Dick Mastergrip



- Non-abrasive, non-slip, handle has open end and a thumb rest
- Seamless connection of steel blade and plastic handle.

Straight Boning Knives



▶ 6 PER BOX.

ITEM NO.	PRODUCT	MFR. NO.	EACH	
			1-5	6+
3186 26131	5" Stiff	8286813-53	\$17.08	\$14.81
3186 25131	6" Stiff	8286815-53	18.98	16.45

Curved Boning Knives



▶ 6 PER BOX.

ITEM NO.	PRODUCT	MFR. NO.	EACH	
			1-5	6+
3186 23131	5" Flex	8288113-53	\$17.08	\$14.81
3186 15141	6" Flex	8288115-53	18.98	16.45
3186 03131	5" Semi-Flex	8288213-53	17.08	14.81
3186 13131	5" Stiff	8289113-53	18.98	16.45
3186 15131	6" Stiff	8289115-53	18.98	16.45

Short Boning Knife



▶ 6 PER BOX.

ITEM NO.	PRODUCT	MFR. NO.	EACH	
			1-5	6+
3186 21041	4" Semi-Flex	8288210-53	\$17.08	\$14.81

Granton® Edge Knives

- Premium stainless steel blade.
- Non-slip plastic handle.
- Safety guard.

Poultry Knives, 3-1/2 Inch



▶ 6 PER BOX.

ITEM NO.	HANDLE	MFR. NO.	EACH	
			1-5	6+
3288 45211	Red Medium	24521R	\$16.25	\$15.15
3288 45231	Green Medium	24521G	16.25	15.15
3288 45221	Red Large	24522R	16.25	15.15

Boning Knives



▶ 6 PER BOX.

ITEM NO.	PRODUCT	MFR. NO.	EACH	
			1-5	6+
3288 65151	5"	26515ER	\$21.25	\$19.89
3288 45501	6" Rigid	24550ER	25.25	23.69
3288 45181	6" Wide Curved	24518ER	21.15	19.74

Counter Knives



▶ 6 PER BOX.

ITEM NO.	PRODUCT	MFR. NO.	EACH	
			1-5	6+
3288 41101	8"	24110ER	\$22.95	\$21.59
3288 41401	10"	24140ER	26.55	24.78

Steak Knife, 10 Inch



▶ 6 PER BOX.

ITEM NO.	PRODUCT	MFR. NO.	EACH	
			1-5	6+
3288 46201	10" Narrow	24620ER	\$40.65	\$37.93

Cooks Knives



▶ 6 PER BOX.

ITEM NO.	PRODUCT	MFR. NO.	EACH	
			1-5	6+
3288 76581	8-1/2"	27658ER	\$33.35	\$31.13
3288 76501	10"	27650ER	39.15	36.53

Butcher Knives



▶ 6 PER BOX.

ITEM NO.	PRODUCT	MFR. NO.	EACH	
			1-5	6+
3288 46081	8"	24608ER	\$36.45	\$34.11
3288 46001	10"	24600ER	40.65	37.93

Beef Slicer Knives



▶ 6 PER BOX.

ITEM NO.	PRODUCT	MFR. NO.	EACH	
			1-5	6+
3288 46581	8"	24658ER	\$23.55	\$22.09
3288 46501	10"	24650ER	28.35	26.47
3288 46521	12"	24652ER	34.95	32.61

Granton® Edge

Patented ground scallops are the secret to the Granton® advantage.

Granton® Edge knives use an innovative fluted edge that creates air cushions which allow for very smooth, fast cutting.

Granton® blades are made from fully hardened and tempered Sheffield stainless steel.



Granton® Handles are double-tapered and ergonomically angled. For added comfort, the thumb platform is contoured and the blade back is rounded.



Developed by Granton® over 50 years ago, the Granton® Edge is a superb razor sharp cutting edge that can be re-sharpened on a steel in the usual way.

Granton® Plain Edge Knives

- Color-coded handles.
- Premium stainless steel blade.
- Hygienic polypropylene co-polymer handle.
- Safety guard.



ITEM NO.	PRODUCT	HANDLE	MFR. NO.
3288 75151	5" Curved	Red	47515ER
3288 75091	5" Straight	Red	47509ER
3288 75161	6" Curved	Red	47516ER
3288 75101	6" Straight	Red	47510ER
3288 75211	6" Narrow	Red	47521ER
3288 05151	5" Curved	Blue	47515EB
3288 05091	5" Straight	Blue	47509EB
3288 05161	6" Curved	Blue	47516EB
3288 05101	6" Straight	Blue	47510EB
3288 05211	6" Narrow	Blue	47512EB
3288 35151	5" Curved	Yellow	47515EY
3288 35091	5" Straight	Yellow	47509EY
3288 35161	6" Curved	Yellow	47516EY
3288 35101	6" Straight	Yellow	47510EY
3288 35211	6" Narrow	Yellow	47521EY
3288 55151	5" Curved	Green	47515EG
3288 55091	5" Straight	Green	47509EG
3288 55161	6" Curved	Green	47516EG
3288 55101	6" Straight	Green	47510EG
3288 00051	6" Narrow	Green	47521EG



Available in four colors.



▶ 6 PER BOX.

EACH	
1-5	6+
\$16.75	\$15.76

Poultry Knife



▶ 10 PER BOX.

ITEM NO.	SIZE	MFR. NO.	EACH	
			1-9	10+
5933 90921	3-1/2"	9092PAM	\$24.03	\$21.01

Boning Knife, 3-3/4 Inch



▶ 6 PER BOX.

ITEM NO.	HANDLE	MFR. NO.	EACH	
			1-5	6+
3367 03131	Black	5.5903.09S	\$14.95	\$13.95
3367 03171	Blue	5.5902.09S	14.95	13.95
3367 03141	Orange	5.5909.09S	14.95	13.95

Slant Point Boning Knife, 3-1/4 Inch



▶ 6 PER BOX.

ITEM NO.	HANDLE	MFR. NO.	EACH	
			1-5	6+
3367 02841	Black	5.5903.08S	\$13.62	\$11.62
3367 03161	Blue	5.5902.08S	13.62	11.62
3367 03001	Orange	5.5909.08S	13.62	11.62

Poultry Knives

- Ergonomically designed.
- Textured, non-slip Fibrox® Pro handle.
- Premium-grade stainless steel. • Resharpenable blades.



VICTORINOX
SWISS ARMY

Slant Point Vent Knives



▶ 6 PER BOX.

ITEM NO.	PRODUCT	MFR. NO.	EACH	
			1-5	6+
3367 18101	3" Small Handle	5.5903.08S	\$13.62	\$12.16

Wide Straight Stiff Knives



▶ 6 PER BOX.

ITEM NO.	PRODUCT	MFR. NO.	EACH	
			1-5	6+
3367 06141	5" Wide Stiff	5.6103.12	\$25.92	\$23.15
3367 00071	6" Wide Stiff	5.6103.15	27.46	22.84

Straight Vent Boning Knives



▶ 6 PER BOX.

ITEM NO.	PRODUCT	MFR. NO.	EACH	
			1-5	6+
3367 18111	3-3/4" Small Handle	5.5903.09	\$14.70	\$13.13
3367 18211	3-3/4" Medium Handle	5.5903.09M	14.70	13.13

Boning Knives



▶ 6 PER BOX.

ITEM NO.	PRODUCT	MFR. NO.	EACH	
			1-5	6+
3367 18121	4-1/2" Small Handle	5.5903.11	\$14.82	\$14.12
3367 18221	4" Medium Handle	5.5903.11M	16.46	15.79



NEED ASSISTANCE?

Our experienced customer service representatives are available to answer your questions, find the products you are looking for, check product availability, as well as take your order.

800-456-5624

Dexter® Ergonomic Poultry Knives

- Designed specifically for poultry processing.
- Stain-free, high-carbon steel hollow-ground blade.
- Textured safety orange polypropylene handle with finger guard.

Clip Point Ergo Knife



▶ 12 PER BOX.

ITEM NO.	PRODUCT	MFR. NO.	EACH	
			1-11	12+
5816 11931	3-1/4"	EP152HG.	\$13.73	\$10.23

Drop Point Ergo Knife



▶ 12 PER BOX.

ITEM NO.	PRODUCT	MFR. NO.	EACH	
			1-11	12+
5816 91531	3-1/4"	EP153-3/4 3°DP.	\$13.61	\$10.11

Utility Ergo Knives



▶ 12 PER BOX.

ITEM NO.	PRODUCT	MFR. NO.	EACH	
			1-11	12+
5816 12131	A. 4-1/2"	EP154HG.	\$13.62	\$10.12
5816 91551	B. 5"	EP155WHG	18.71	12.88

Hollow Ground Ergo Knife



▶ 12 PER BOX.

ITEM NO.	PRODUCT	MFR. NO.	EACH	
			1-11	12+
5816 12331	A. 6"	EP156HG.	\$19.88	\$14.05
5816 14031	B. 6" Safety Tip	EP156HG-ST	20.41	17.76

Wide Stiff Ergo Knife



▶ 12 PER BOX.

ITEM NO.	PRODUCT	MFR. NO.	EACH	
			1-11	12+
5816 91361	6"	EP136	\$19.89	\$14.06

Trim Ergo Knife



▶ 12 PER BOX.

ITEM NO.	PRODUCT	MFR. NO.	EACH	
			1-11	12+
5816 11831	2-1/2"	EP151HG.	\$13.73	\$10.23

Dexter® Economy Poultry Knives



- Stain-free, high-carbon steel hollow-ground blade.
- Textured black polypropylene handle with finger guard.

Slant Point Boning/Paring Knife



▶ 12 PER BOX.

ITEM NO.	PRODUCT	MFR. NO.	EACH	
			1-11	12+
5816 11031	3"P152HG.	\$12.76	\$9.27

Vent Boning/Paring Knife



▶ 12 PER BOX.

ITEM NO.	PRODUCT	MFR. NO.	EACH	
			1-11	12+
5816 11131	3-1/2"P153HG.	\$13.73	\$10.23

Utility Boning Knives



▶ 12 PER BOX.

ITEM NO.	PRODUCT	MFR. NO.	EACH	
			1-11	12+
5816 11231	A. 4"P154HG.	\$13.62	\$10.12
5816 11331	B. 5"P155WHG	17.44	12.77
5816 11431	C. 6"P156HG.	18.71	14.05

Ergo Sharp® Poultry Knives



- Comfort designed, patented ergonomic soft grip handle.
- Premium grade stainless steel blade.



▶ 12 PER BOX.

ITEM NO.	PRODUCT	MFR. NO.	EACH	
			1-11	12+
3294 08021	A. 3-3/4" Slant Point.	EG-802-SH	\$9.85	\$8.60
3294 08061	B. 6"	EG-806-LH.	15.45	14.25

Double-Bladed Knife

Ideal knife for cutting along poultry keel bones.

- Simply remove the screw and the double-bladed knife becomes two separate knives with handles — allowing for easy sharpening.
- Optional dual edge sharpener allows both blade edges to be sharpened simultaneously.

NOTE: Steel and table-mount sharpener both sold separately.

ITEM NO.	PRODUCT	EACH
3523 10151	Double-Bladed Knife.....	\$87.39
3523 24001	Table-Mount Sharpener.....	118.95



Sharpen with steel of choice or optional table-mount sharpener.

Double-Bladed Keel Knife

Choose between 1/8-inch spacing or 1/4-inch spacing for larger fowl.

- Replacement handles, blades, binding posts and screws available.
- Ergonomically designed pistol grip. • Blades may be sharpened independently.

ITEM NO.	PRODUCT	EACH
0891 10011	1/8" Spacing.....	\$44.95
0891 10021	1/4" Spacing.....	44.95



Dual Blade: Cuts on both sides of the keel bone with one stroke, unlike one-bladed knives which require two strokes.

Scalpel Knives

- Easy to replace, wrapped, stainless steel blades.
- Contoured, textured handle.
- Length: 2.876 inches.

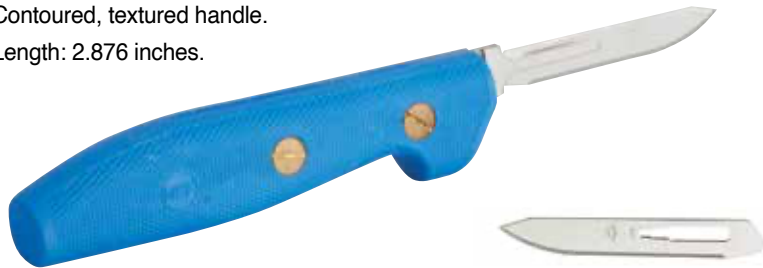

ITEM NO.	PRODUCT	EACH
3363 00431	Poly Blue Scalpel Knife Handle.....	\$36.25
1060 80265	#60 Poultry Blades, Stainless Steel (150/Box).....	174.70

Loin Knives

- Blade width: 1-5/8 inches.
- Rigid knife has a 1/8-inch thick blade, flexible knife has a 1/16-inch thick blade.
- White handle.



ITEM NO.	PRODUCT	MFR. NO.	F.O.B. FACTORY EACH
3955 0339	8" Rigid.....	325R-REG.....	159.48
3955 0324	8" Flexible.....	325F-REG.....	171.33
3955 0333	12" Flexible.....	327F-400H.....	199.38
3955 0404	17-1/2" Left-Handed....	404LH.....	188.83
3955 9408	17-1/2" Right-Handed...	404RH.....	188.82

Sausage Testing Knife with Fork

- 4-inch stainless steel blade.
- Knife and fork on opposite ends.
- Folds up with convenient pocket clip.



► SEE PAGES 465 - 468
For Casings

ITEM NO.	PRODUCT	MRF. NO.	EACH
3186 01111	4" Sausage Testing Knife.....	8200111.....	\$41.75





Scalloped Sani-Safe® Paring Knife NSF

- Grip-Tex handle prevents slippage.
- Serrated edge.



▶ 12 PER BOX.

F.O.B. FACTORY EACH

ITEM NO.	PRODUCT	MFR. NO.	1-11	12+
5816 55631	3-1/2" Scalloped	S105SC	\$8.95	\$6.62

Pinner Knife

- Textured polypropylene handled knife.
- Stain-free, high-carbon steel blades.



▶ 12 PER BOX.

EACH

ITEM NO.	PRODUCT	MFR. NO.	1-11	12+
5816 10731	2-1/2" Pinner	S130	\$14.88	\$10.22

Frankfurter Sani-Safe® Skinner NSF



▶ 12 PER BOX.

EACH

ITEM NO.	PRODUCT	MFR. NO.	1-11	12+
5816 95531	1-3/4"	S410	\$16.18	\$11.51

Sticking Knife

- Swedish high-carbon, no-stain steel to gives the best service and life.
- White, polyamide microblasted custom handle for optimum protection.
- Designed for both diagonal and dagger positions – sabre grip helps avoid slipping.
- Double-edged blade.



A



B

▶ 10 PER BOX.

EACH

ITEM NO.	PRODUCT	MFR. NO.	1-9	10+
6818 30451	A. 6-3/4" Stiff	1-0144	\$60.43	\$57.40
6818 30431	B. 8" Stiff	14211	62.43	59.40

Sani-Safe® Paring Knives, 3-1/4 Inch

- Color-coded handles help prevent cross-contamination.
- 3-1/4-inch blade with Sani-Safe® grip handles.

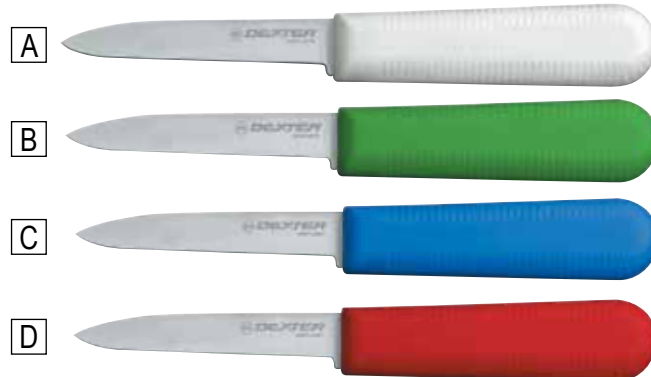

▶ 12 PER BOX.

EACH

ITEM NO.	HANDLE	MFR. NO.	1-11	12+
5816 53031	A. White	S104	\$8.22	\$5.68
5816 00231	B. Green	S104G	8.22	5.68
5816 01941	C. Blue	S104B	8.22	5.68
5816 55331	D. Red	S104R	8.22	5.68

Sticker Knife

- Textured white polypropylene handle.
- Stain-free, high-carbon steel blade.



▶ 12 PER BOX.

EACH

ITEM NO.	PRODUCT	MFR. NO.	1-11	12+
5816 10431	3" Sticker	S128	\$16.18	\$11.51

Granton® Turning Knife with Metal Detectable Handle

- Used for peeling fruits and vegetables.
- Blue handle is metal detectable.



▶ 12 PER BOX.

EACH

ITEM NO.	PRODUCT	MFR. NO.	1-11	12+
3288 45051	2-1/2" Curved	44505EBD	\$9.85	\$8.75

Meat Cleaver

- Hatchet style, ideal for hacking through bone.
- Knife's broad side can also be used for crushing in food preparation, such as garlic.



VICTORINOX SWISS ARMY



ITEM NO.	PRODUCT	MFR. NO.	EACH
3367 9001	7" x 2-1/2"	5.4003.18	\$74.80

Polypropylene Handle Paring Knives

"Little Vicky" Paring Knives



▶ 12 PER BOX.

ITEM NO.	PRODUCT	HANDLE	MFR. NO.	EACH	
				1-11	12+
3367 03031	A. 3-1/4" Wavy	6.7631	6.7631	\$6.96	\$5.96
3367 61151	B. 3-1/4" Straight	6.7606.L115	6.7606.L115	6.34	4.98
3367 03051	C. 3-1/4" Straight	6.7603	6.7603	6.96	5.96
3367 03081	4" Straight	6.7703	6.7703	7.84	6.84
3367 03071	D. 3-1/4" Wavy	6.7633	6.7633	7.84	6.84
3367 03021	E. 2-1/4" Curved	6.7503	6.7503	7.84	5.84

Paring Knives

• High carbon stainless steel.



Curved Paring Knife



Sani-Safe® Cheese Knife



▶ 6 PER BOX.

ITEM NO.	PRODUCT	MFR. NO.	EACH	
			1-5	6+
5816 03011	12"	S11812	\$64.82	\$45.00

Sani-Safe® Double-Handled Cheese Knife



▶ 2 PER BOX.

ITEM NO.	PRODUCT	MFR. NO.	EACH	
			1	2+
5816 0051	14"	S11814D	\$97.26	\$66.94



Sani-Safe® Vegetable Knife



▶ 12 PER BOX.

ITEM NO.	PRODUCT	MFR. NO.	EACH	
			1-11	12+
5816 0145	3-1/2"	S151	\$16.18	\$11.51

Round Point Melon Knife

• Cimeter-style knife. • Soft rubber grip handle.



▶ 6 PER BOX.

ITEM NO.	PRODUCT	MFR. NO.	EACH	
			1-5	6+
5816 49851	8"	SG132-8	\$38.64	\$28.14

Sani-Safe® 68



▶ 12 PER BOX.

ITEM NO.	PRODUCT	MFR. NO.	EACH	
			1-11	12+
5816 01851	5" Produce	S485	\$19.88	\$14.05

▶ 6 PER BOX.

ITEM NO.	PRODUCT	MFR. NO.	EACH	
			1-5	6+
5816 11861	6" Produce	S186	\$21.15	\$15.32

Oyster Knives

- SuperGrip handle prevents slipping.
- New Haven knife has a hooked tip to help pry open shells.
- Boston knives have round tip for extra leverage.
- Galveston knife has a broad straight-edged blade.



VICTORINOX
SWISS ARMY



▶ 6 PER BOX.

ITEM NO.	PRODUCT	MFR. NO.	EACH	
			1-5	6+
3367 46921	A. Providence, 2-3/4" Blade	7.6399.2	\$16.52	\$14.58
3367 46931	B. New Haven, 2-3/4" Blade	7.6399.3	16.52	14.58
3367 46941	C. Boston, 3" Blade	7.6399.4	16.52	14.58
3367 46961	D. Boston, 4" Blade, Narrow	7.6399.6	17.40	15.30
3367 46951	E. Galveston, 4" Blade	7.6399.4	17.40	15.30

Dexter® Sani-Safe® Seafood Knives

A textured, slip-resistant, easy-to-clean polypropylene handle withstands both high and low temperatures.

DEXTER

Sliming Knife



▶ 6 PER BOX.

ITEM NO.	PRODUCT	MFR. NO.	EACH	
			1-5	6+
5816 13381	4-1/2" Blade	S125	\$24.86	\$23.69

Clam Knife



▶ 12 PER BOX.

ITEM NO.	PRODUCT	MFR. NO.	EACH	
			1-11	12+
5816 04431	A. 3" Blade, 6" Overall	S127	\$12.77	\$9.24
5816 00281	B. 3-2/5" Blade, 7-2/5" Overall	S129	13.73	10.23

Gut Knife with Spoon



▶ 6 PER BOX.

ITEM NO.	PRODUCT	MFR. NO.	F.O.B. FACTORY EACH	
			1-5	6+
5816 01471	A. 4-1/2" Blade	S133-4CP	\$24.86	\$23.69
5816 01761	B. 6" Blade	S133-6CP	24.86	23.69

Catfish Boning Knife

- Yellow, sure grip textured handle.
- Protective finger guard.
- Proprietary DEXSTEEL blade.



▶ 6 PER BOX.

ITEM NO.	PRODUCT	MFR. NO.	EACH	
			1-5	6+
5816 03131	6" Narrow, Curved Flex	C131F-6	\$24.65	\$18.05

FREE GROUND SHIPPING*

when you place an order for \$500 or more from THIS BUYERS GUIDE!

*FREE SHIPPING does NOT include UPS Next Day Air, UPS 2nd Day or UPS 3rd Day Select. Certain items may not qualify. This offer is good only on orders shipped UPS Ground in the 48 contiguous states. Based on dimensional weight, we will determine the most efficient means of shipment, either UPS or LTL. Products may ship by truckline.



Filleting Knives

For Additional Information ▶ SEE PAGE 343



▶ 10 PER BOX.

ITEM NO.	SIZE	MFR. NO.	HANDLE	BLADE	EACH	
					1-9	10+
6818 00411	A. 7"	9180P	P Grip	Flex	\$18.74	\$15.74
6818 00211	B. 7" Narrow	9174P	P Grip	Flex	19.08	15.90
6818 00361	C. 8"	9197UG	UG Grip	Flex	20.96	17.96
6818 00381	7"	9218UG	UG Grip	Med-Flex	21.86	18.86
6818 00331	D. 8"	9197PG	Pro Grip	Flex	19.90	16.90
6818 00371	8" Narrow	9218PG	Pro Grip	Flex	22.48	18.48
6818 00281	E. 8" Wide	9210P	P Grip	Med-Flex	20.68	17.68

Straight Wide Boning Knives



▶ 10 PER BOX.

ITEM NO.	SIZE	MFR. NO.	HANDLE	BLADE	EACH	
					1-9	10+
6818 00251	A. 5"	9153PG	Pro Grip	Stiff	\$17.96	\$14.96
6818 00241	B. 6"	9153P	P Grip	Stiff	14.96	112.96

Gutting and Cleaning Knives



▶ 10 PER BOX.

ITEM NO.	SIZE	MFR. NO.	HANDLE	BLADE	EACH	
					1-9	10+
6818 00191	5"	299P	P Grip	Stiff	\$21.82	\$18.18
6818 00171	6"	9152P	P Grip	Stiff	21.82	18.18
6818 00201	7"	1040S	P Grip	Stiff	21.82	18.18

FROST FLEX INDEX

Carefully selected steel enables knives to be sharpened to an extreme edge and sharpness that lasts.



Butcher/Trimming Knives

For Additional Fish Knives ▶ SEE PAGE 367



▶ 10 PER BOX.

ITEM NO.	SIZE	MFR. NO.	HANDLE	BLADE	EACH	
					1-9	10+
6818 00351	A. 6"	9150	PS Grip	Stiff	\$17.24	\$14.24
6818 00271	B. 6"	9150PS	PS Grip	Stiff	18.10	15.10
6818 00401	C. 10"	7253UG	UG Grip	Stiff	47.66	39.66

Chefs Knives



▶ 10 PER BOX.

ITEM NO.	SIZE	MFR. NO.	HANDLE	EACH	
				1-9	10+
6818 00231	A. 7"	4171PG	Pro Grip	\$30.30	\$25.30
6818 00221	B. 9"	4216PG	P Grip	36.34	30.34
6818 00181	C. 10-1/2"	4261UG	UG Grip	42.30	37.30

FROSTS SEAFOOD KNIFE HANDLES

Handles Made of Polypropylene

P	Pro G	UG Grip	PS Grip
Glass Fiber Reinforced Polypropylene — rough, durable grip.	Molded Textured Rubber — enhanced non-slip grip.	Hard Polyamide — soft feel, wear- and oil/fat-resistant.	Smaller Size of the P-Grip Handle.

Blades made of recycled Swedish stainless steel knife. Recommended for seafood processing.



The perfect showcase for your retail business.

Hunting Knives

- Stainless blade with orange handle.
- Includes easy clean sheath.

Curved Boning



► 5 PER BOX. EACH

ITEM NO.	PRODUCT	MFR. NO.	BLADE	1-4	5+
6818 00441	5" Curved...	14231...	Flex...	\$36.99	\$32.00

Butcher



► 5 PER BOX. EACH

ITEM NO.	PRODUCT	MFR. NO.	BLADE	1-4	5+
6818 00461	6.5".....	14233...	Flex..	\$42.99	\$33.90

Straight Boning



► 5 PER BOX. EACH

ITEM NO.	PRODUCT	MFR. NO.	BLADE	1-4	5+
6818 00471	A. 6".....	14234...	Stiff...	\$39.99	\$32.00
6818 00481	B. 5.25"....	14235...	Flex..	\$39.99	\$32.00

Skinning



► 5 PER BOX. EACH

ITEM NO.	PRODUCT	MFR. NO.	BLADE	1-4	5+
6818 00451	5.75".....	14232...	Stiff...	\$42.99	\$33.90

Sharpening Steel

- Regular cut. • Includes belt ring.
- Carbon steel with orange handle.



► 5 PER BOX. EACH

ITEM NO.	PRODUCT	MFR. NO.	1-4	5+
6818 00491	8".....	14238.....	\$36.99	\$30.10

Orange Handle Axe

- Axe head constructed of black epoxy coated boron steel.
- Reinforced plastic handle.
- 12-1/2 inches H x 4-1/2 inches W.



Includes a leather sheath for axe head.

ITEM NO.	PRODUCT	EACH
5933 00051	Orange-Handled Axe	\$75.28



Soft Hunting Knife Case

- Holds five knives and one steel.
- Made of olive and orange polyester.



NOTE: Cutlery NOT INCLUDED.

► 5 PER BOX. EACH

ITEM NO.	MFR. NO.	1-4	5+
6818 00501	14213.....	\$38.99	\$31.95

Kansbol Hunting Knife

- Stainless blade with oragne and olive handle.
- Includes hard plastic sheath with belt loop.



▶ 5 PER BOX.

EACH

ITEM NO.	PRODUCT	MFR. NO.	1-4	5+
6818 00511	Kansbol Knife	14236	\$53.99	\$37.55

Eldris Hunting Knife

- Stainless blade with orange and olive handle.
- Includes hard plastic sheath with belt loop.



▶ 5 PER BOX.

EACH

ITEM NO.	PRODUCT	MFR. NO.	1-4	5+
6818 00521	Eldris Knife	14237	\$43.99	\$34.55

Packaged for your retail display.



Companion Fillet w/Sheath

Ideal to work safely and efficiently in wet environments.

- The ergonomic polymer handle features a soft friction grip and a finger guard
- Blade made of recycled Swedish stainless steel.
- Sheath includes a belt clip.

▶ 10 PER BOX.



Packaged for your retail display.

▶ SEE PAGE 365 For Additional Seafood Knives



Includes safety clip on sheath to hold knife securely.

ITEM NO.	SIZE	MFR. NO.	BLADE	1-9	10+
6818 00161	A. 4"	090(S)	Flex	\$22.42	\$18.42
6818 00431	B. 6"	155(S)	Flex	28.02	24.02



Wood Devil Hand Axe

The ultimate hand-axe for chopping, splitting and quartering big game.

- Ergonomic non-slip thermo-plasticized rubber handle ensures a positive grip — even when wet.
- Full tang 3Cr13 stainless steel construction with black oxide protective coating.
- Two hammer surfaces: on back of head and on butt of handle. • Weight: 1-1/5 pounds.
- 10 inches H x 5-1/5 inches W. • Includes a nylon sheath.

ITEM NO.	PRODUCT	EACH
3344 10021	Wood Devil Hand Axe	\$42.95



11-Piece GamePro Processing Kit

Great for the hunter, camper or outdoor chef.

- Precisely heat treated 420J2 stainless steel blades ensure excellent edge retention.
- Taper ground full-tang blades are durable and perfectly balanced.
- Nonslip TPR handles ensure a safe, comfortable grip after periods of long use.

Kit includes:

2-3/5-inch Caping Knife	Rib Cage Spreader
4-2/5-inch Gut Hook Skinner	Two Stage Sharpener
5-1/2-inch Boning/Fillet Knife	Game Cleaning Gloves
7-1/2-inch Butcher Knife	Cutting Mat
Game Shears	Hard Sided Carrying Case
10-inch Wood/Bone Saw	



ITEM NO.	PRODUCT	EACH
3344 00031	11-Piece GamePro Processing Kit	\$94.35

WE ARE YOUR GAME SEASON HEADQUARTERS

Request your FREE copy of our

GAME SEASON CATALOG
1-800-456-5624

Follow our GAME SEASON board on PINTEREST

Gear up and join us:
www.pinterest.com/bpdkochsupplies

7-Piece Rosewood Handled Block Set

- Includes: 3-1/4" paring, 6" boning, 8" chef's, 8" bread, 10" slicer, 10" sharpening steel in a slant oak block, 6 slot.



VICTORINOX
SWISS ARMY



ITEM NO.	PRODUCT	MFR. NO.	EACH
3367 03191	6-Piece Rosewood Block Set	5.1190.7-x1	\$404.42

8-Piece Fibrox Handled Block Set

- Includes: 4" paring, 6" boning, 8" chef's, 8" bread, 10" slicer, 10" steel, kitchen shear in a slant oak block, 7 slot.



VICTORINOX
SWISS ARMY



ITEM NO.	PRODUCT	MFR. NO.	EACH
3367 03181	8-Piece Block Set	5.1193.8-x2	\$224.10

Fibrox Handle Cutlery Roll Set

- Includes 4-in. paring knife, 5-in. curved boning knife, 8-in. carving knife, 8-in. bread knife, 10-in. chef's knife, 10-in. honing steel in a canvas roll storage case.



VICTORINOX
SWISS ARMY



ITEM NO.	PRODUCT	MFR. NO.	EACH
3367 03211	Cutlery Roll Set	7.4012-x10.	\$273.00

Portable Cutlery Cases



Store and transport your knives safely!

- Constructed of durable nylon with shoulder strap.
- Choose from 3 or 7 knife capacity.

NOTE: Cutlery NOT INCLUDED.



ITEM NO.	PRODUCT	MFR NO.	EACH
5816 0206	A. 3-Piece Knife Case20206.	\$28.67
5816 0153	B. 7-Piece Knife Case20204.	46.06

Portable Knife Case

Store and transport knives safely!

- Constructed of durable polyester.
- Holds up to 13 knives. • Color: black.



VICTORINOX
SWISS ARMY



ITEM NO.	PRODUCT	MFR NO.	EACH
3367 4904	14" Knife Case	44904.	\$65.30

Magnetic Knife Rack

Utilizes space allowing an unspecified number and size of cutlery tools to be stored off of countertops.

- Black molded plastic surrounds two magnetic strips.
- Easily mounts to wall utilizing two screws.
- Clean by wiping with a damp cloth.



NOTE: Cutlery tools NOT INCLUDED.

ITEM NO.	PRODUCT	DIMENSIONS	EACH
4894 55181	Magnetic Knife Rack	8" x 1" x 1-1/2"	\$22.32

Knife and Tool Holders

A. Plastic Knife Holder

- Holds 12 knives, 1 cleaver and 1 steel.
- Safe, easy-to-clean housing.
- Will not rust or dull knives.

B. Stainless Steel Tool Holder

- Reversible, replaceable neoprene rubber insert removes for cleaning.
- Heavy-gauge stainless steel guard has side hooks to hold butcher saw.
- Holds 7 knives and 3 steels.

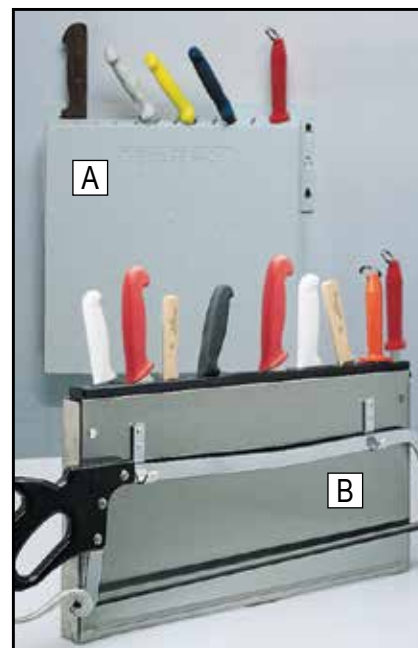

NOTE: Knives and tools SOLD SEPARATELY.

ITEM NO.	PRODUCT	DIMENSIONS	EACH
3278 0151	A. Plastic Knife Holder	16" x 3" x 15"	\$41.05
3060 05611	B. Stainless Steel Holder	23" x 1" x 12"	46.15
3060 0562	Replacement Insert (for #3060 05611)		21.95

Single Knife Scabbard with Strap

Scabbard holds one knife.

- Fits multiple sizes of knives.
- Size: 9-1/2 inches.
- Color: white.



ITEM NO.	PRODUCT	EACH
3186 00481	Single Scabbard	\$14.22

Knife Sheaths



A. Leather Sheath

- Use with any straight knife up to 6 inches in length.
- Attaches easily to belt for easy access.

B. Poly Sheath

- Designed for paring knives up to 4 inches in length.

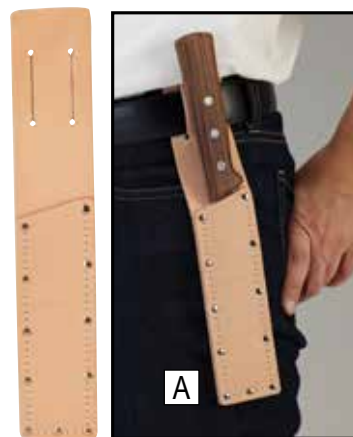

ITEM NO.	PRODUCT	EACH
5816 0400	A. 6" Leather Sheath	\$9.28
5816 0490	B. 4" Poly Sheath	2.61

Aluminum Scabbards with Removable Front

- Made of seamless, heavy-gauge aluminum.
- Removable panels for easy cleaning and sanitation.

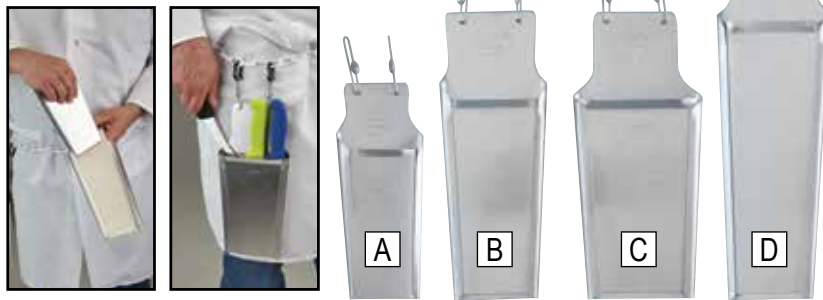

▶ 12 PER BOX.

ITEM NO.	PRODUCT	SIZE	EACH
3025 0004	A. 2 Small Knife Pouch	3-1/2" x 10"	\$18.95
3025 0001	B. 2 Knife Pouch	4-1/2" x 13"	19.95
3025 0003	C. 3 Knife Pouch	6" x 13"	24.95
3025 0005	D. 2 Large Knife Pouch	5" x 16"	24.95

Aluminum Scabbards with Boning Hook Clip

- Single hinge design, made of seamless, heavy-gauge aluminum.
- Removable panels, for easy cleaning and sanitation.
- Single row: holds 3 knives, with up to 7-inch blades.
- Double row: holds up to 6 knives, with up to 10-inch blades.



▶ 24 PER BOX.

ITEM NO.	PRODUCT	SIZE	EACH
3554 57941	A. Single	5" x 10-1/2"	\$15.82
3554 57951	B. Double	5" x 13-1/4"	27.75

Non-Dulling Poly Scabbards

- Available with or without boning hook clip.
 - Molded of long-lasting, easy-to-clean white polyethylene.
- A. Holds 2-3 knives, up to 12 inch blade length.
 B. Holds 2-3 knives, with up to 8 inch blade length.

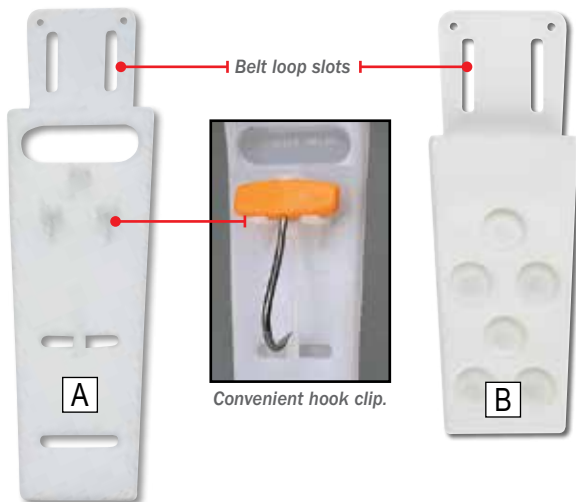

▶ 12 PER BOX.

ITEM NO.	PRODUCT	SIZE	EACH
4219 20711	A. w/Clip	5-1/2" x 18"	\$13.94
3845 94121	B. w/o Clip	4-1/2" x 13"	9.15

Plastic Knife Scabbards

Removable pouch front for easy cleaning!

- Seamless molded white polyethylene construction with notches to keep knives secure when you bend over.
- Extended scabbard neck allows knives to hang at a more comfortable grasping level.



Angled flange keeps knives nestled close to scabbard and safely out of the way.

Pouch front slips out of scabbard frame for easy cleaning.

NOTE: Sizes shown are actual pouch dimensions. Add 6-1/2 inches to length shown above for overall scabbard length.



Scan this QR code with your mobile device to watch a video about plastic vs. metal scabbards.

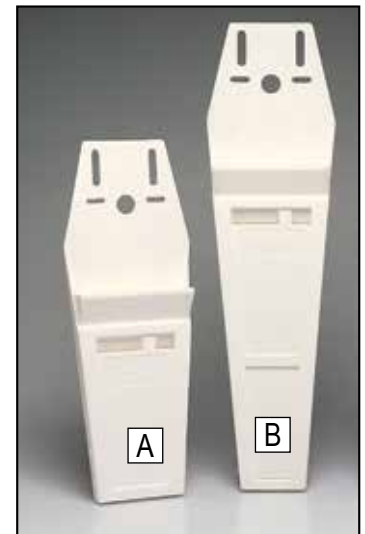

ITEM NO.	PRODUCT	EACH
3288 80001	A. 5" x 9"	\$17.55
3288 80011	B. 5" x 14"	19.75

Bulk Scabbard Chains

- Stainless and zinc available in 100-foot rolls.
- Plastic chain in 250-foot rolls.
- 48-inch welded stainless steel scabbard chain with 'S' hook (12 pound capacity).

NOTE: Optional stainless steel S-hooks AVAILABLE SEPARATELY.

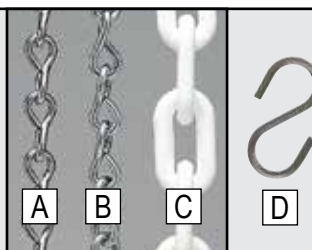

ITEM NO.	PRODUCT	LENGTH	ROLL
3428 9640	A. Stainless Steel	100' Roll	\$179.95
3428 9639	B. Zinc Plated	100' Roll	69.91
3600 0281	C. 1" Plastic	250' Roll	211.95
3600 0101	1-1/2" Plastic	200' Roll	201.35
4200 0048	Stainless Steel w/'S' Hook	48"	13.13
4670 37001	Plastic w/Swivel Hook	54"	13.95
3428 85721	D. "S" Hook, Stainless Steel		1.06

Boning, Node and Selecting Hooks

- Slip-resistant textured polypropylene handle.
- Stainless steel hook.

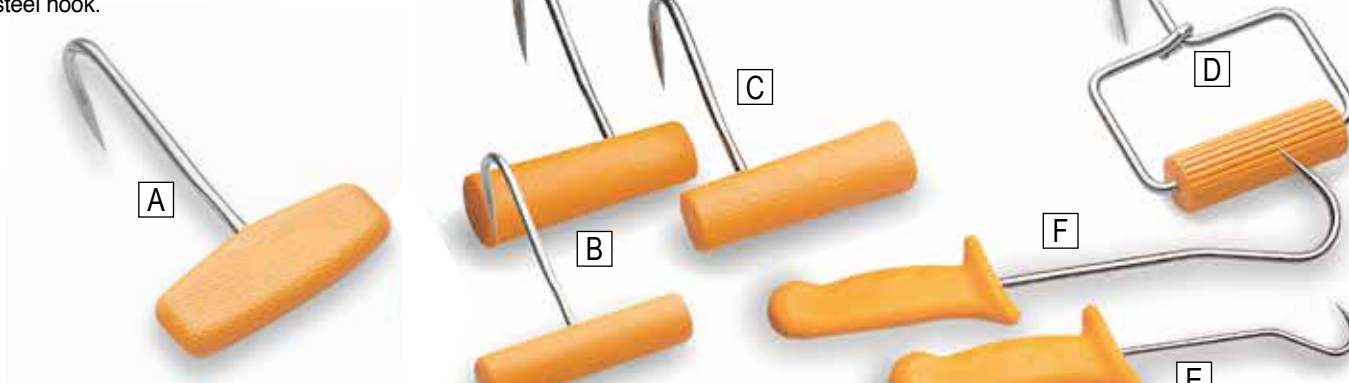

A. Flat Handle Boning Hook

B. Round Handle Hook

- Designed for smaller hands and greater comfort.

C. Tapered Handle Boning Hook

- Available in both right hand or left hand/center or offset hook.

D. Ergonomic Ribbed Open Grip Boning Hook

- No hook shank between fingers to cause discomfort and glove breakage.

E. Node Hook

- 5-1/2-inch stainless steel hook. • Safety slip-guard.

F. Selecting Hooks

- Safety slip-guard.

► 12 PER BOX.

ITEM NO.	PRODUCT	EACH
3145 03241	A. 3-2/5" Hook, Flat Handle	\$14.89
3145 03251	4" Hook, Flat Handle	16.15
3145 03261	5-1/2" Hook, Flat Handle (6/Box)	17.44
3145 33251	B. 4" Hook, Round Handle	17.44
3145 13251	C. 4" Center Hook, Right Taper Handle	17.44
3145 53251	4" Offset Hook, Right Taper Handle	17.44
3145 63251	4" Offset Hook, Left Taper Handle	17.44
3145 23251	4" Center Hook, Left Taper Handle	17.44
3145 03231	D. 4" Hook, Ribbed Open Grip Handle	32.38
3145 03101	E. 5-1/2" Node Hook	17.44
3145 16001	F. 12" Selecting Hook	22.42
3145 26001	16" Selecting Hook	27.40
3145 36001	20" Selecting Hook	31.11

All Metal Boning Hooks

- Sure-grip hexagonal aluminum "T"-handle with stainless steel hook.



► 12 PER BOX.

ITEM NO.	PRODUCT	EACH
2321 2911	3-3/4"	\$13.35
2321 30021	6-3/4"	13.65

Node Hook

- Textured, white polypropylene handle.
- 6-inch stainless steel hook.



► 6 PER BOX.

ITEM NO.	PRODUCT	EACH
5816 49231	6" Node Hook	\$19.88

Stainless Steel 'S' Meat Hanging Hooks

- Solid 18-8 Type 304 stainless steel. • Sharp, smooth points on both ends.
- Electropolished to a bright smooth finish.

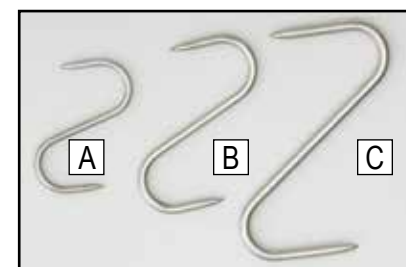

ITEM NO.	PRODUCT	EACH
2321 2312	A. 1/4" x 4" with 50 lb Max Load	\$4.15
2321 23161	B. 0.3" x 6" with 100 lb Max Load	6.35
2321 2319	C. 2/5" x 8" with 250 lb Max Load	8.55

Bone Dust Removers

- Tapered blade to ensure 100% clean wipe.
- Stainless steel remover has replaceable high-tension spring blades mounted to an aluminum handle.

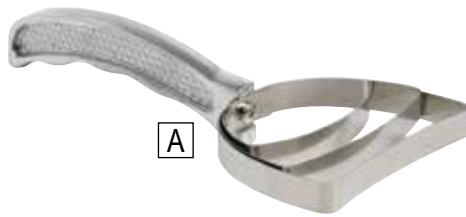

A



B

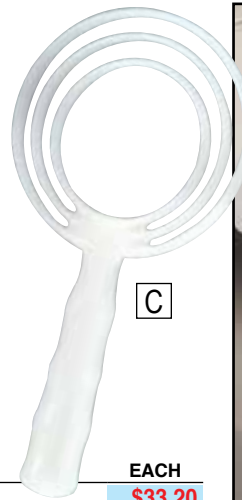

C



ITEM NO.	PRODUCT	EACH
3845 02941	A. Stainless Steel	\$33.20
4219 11251	B. Poly	5.45
5816 93231	C. Round Poly	9.78

Dough Cutter

- Withstands high and low temperatures.
- Stain-free, high-carbon steel with slip-resistant polypropylene handle.



▶ 6 PER BOX.

ITEM NO.	PRODUCT	EACH
5816 01961	6" x 3" Dough Cutter	\$15.97

Tramontina Dough Cutter/Scraper



Textured white polypropylene handle provide slip-resistant grip.



- Dishwasher safe.
- Stain-free, high-carbon chrome molybdenum steel.



ITEM NO.	PRODUCT	EACH
3450 92161	6" x 3" Dough Cutter/Scraper	\$14.95

Hamburger Paddle

- Smooth construction prevents bacteria and germs.
- Can withstand food temperature up to 180°.
- Nice size handle for stirring leverage.
- Made of white molded polyethylene.
- 8-1/2 inches L x 3 inches W.
- Easy to clean.



ITEM NO.	PRODUCT	EACH
3845 85801	Hamburger Paddle	\$10.12

Three-Row Tenderizer

- Three rows of spring-loaded, razor-sharp blades pierce meat and retract safely after each cut.
- Tenderizes by cutting connective tissue in the meat.
- Surface of the meat remains unchanged and all the juice is retained.



Sheath to cover blades when not in use.

ITEM NO.	PRODUCT	EACH
3363 96011	Three-Row Tenderizer	\$35.79

Sani-Safe® Cooks Fork

- Textured, slip-resistant, easy-to-clean polypropylene handle withstands both high and low temperatures.
- Tines are made from stain-free, high-carbon steel, with an individually ground and honed edge.
- An impervious blade-to-handle seal provides the utmost in sanitary performance.
- Excellent in commercial use.

DEXTER



ITEM NO.	PRODUCT	EACH
5816 44431	13" Cooks Fork	\$31.11

Utility Tongs

- Stainless steel.
- Heavy-duty.

VOLLRATH®



ITEM NO.	PRODUCT	EACH
7160 71441	16" Utility Tongs	\$11.35

Roast Beef Tier

- Plastic handle has flat bottom to prevent rolling when placed on a surface.
- 12-inch stainless steel blade.

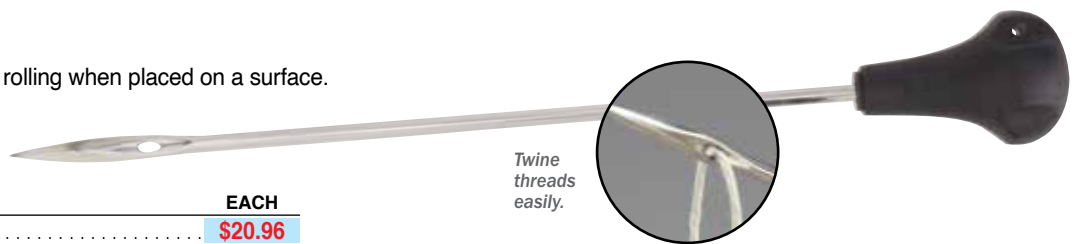

ITEM NO.	PRODUCT	EACH
1044 1306	Roast Beef Tier	\$20.96

Hamburger Turners

Textured white polypropylene handles provide slip-resistant grip.

- Stain-free, high-carbon chrome molybdenum steel.
- Superior blade shape for easier slicing.
- Stain-free, high-carbon steel.
- Dishwasher safe.

DEXTER

A



B



ITEM NO.	PRODUCT	MFR. NO.	EACH
5816 01701	A. 4" x 3" Hamburger Turner	P94854	\$17.01
5816 0260	B. 5" x 4" Hamburger Turner	S285-4	\$36.20

Sani-Safe® Bakers Spatula

The ideal spatula for finishing cakes and desserts.

- Sani-Safe® polypropylene handle is slip resistant and withstands high and low temperatures.
- Impervious blade-to-handle seal.

DEXTER



▶ 6 PER BOX.

ITEM NO.	PRODUCT	EACH
5816 84101	10" Bakers Spatula	\$28.67

Sandwich Spreader



- Scalloped blade.
- White, plastic handle.



▶ 12 PER BOX.

ITEM NO.	PRODUCT	EACH
4894 56881	3-1/2" Sandwich Spreader	\$6.22

Corn Dog Sticks, 5-1/2 Inch

Ideal for corn dogs, grilling shrimp and scallops. Also great for use with strawberries, other fruit and desserts.

- Flat stick.
- Machine beveled rounded ends.



▶ 10,000 PER CASE.

ITEM NO.	PRODUCT	CASE
3419 1005	Corn Dog Sticks	\$113.65

Hickory Skewers

- Perfect for standard sized corn dogs and candy apples.
- Size: 4-1/2 inches x 11/64 inch point.
- Sharp pointed end.



▶ 1,000 PER BOX.

ITEM NO.	PRODUCT	BOX
3953 09825	Wooden Sharp Point Skewer	\$36.07

Nylon Filet Skewers

- Constructed of heat-stabilized, food-grade nylon.
- For use in temperatures up to 500 °F.
- Eliminates the use of toothpicks (which can splinter and break) and metal objects in meat products.
- FDA and USDA approved.
- Microwave safe.

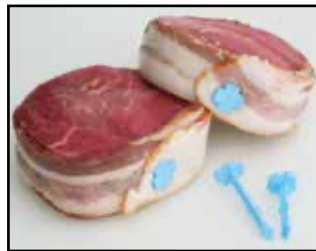

▶ 2,500 PER BAG.

ITEM NO.	PRODUCT	BAG
7154 1004	1" Nylon Skewers	\$159.95
7154 1003	2" Nylon Skewers	169.95

Stainless Steel Skewers, 11 Inch

- Stainless steel construction will not rust or stain.



▶ 125 PER BOX.

ITEM NO.	PRODUCT	EACH
4804 00111	Stainless Skewers	\$0.82

Lopping Shear

A fully hardened, precision-ground steel blade stays sharp and a rust-resistant, low-friction coating makes every cut even easier.

- For added control, durable steel construction is enhanced with non-slip grips.
- Bypass blade style. • Overall length: 28 inches.
- Steel construction provides lasting durability.
- Maximum cutting capacity: 1-1/2 inch diameter.

FISKARS®



ITEM NO.	PRODUCT	EACH
3519 00071	Lopping Shear	\$26.95

SHOP 24/7
bunzlpd.com



Need Help?
Chat With Us
Online!

SoftHandle Shears

Soft, light-weight ergonomic handles.

- Standard, large or extra large lower bows available. Excellent for applications that require gloves.
- Long-lasting polyolefin handle provides resistance to chemicals, fats and oils.
- Extra sharp stainless steel blades hold an incredible edge.
- Cut length: 3-1/4 - 3-3/4 inches.

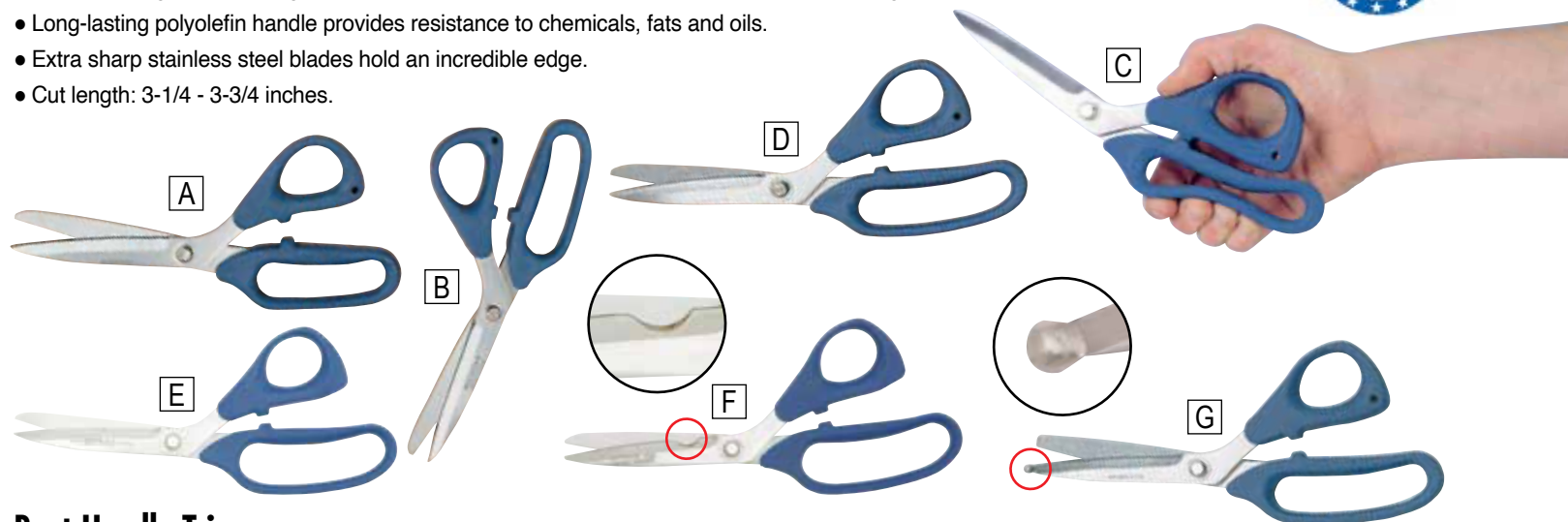

Bent Handle Trimmers

▶ 6 PER BOX.

ITEM NO.	PRODUCT	MFR NO.	EACH
3318 72101	A. 8-1/4" Trimmer, Standard Bow Handle, Straight, Ambidextrous	7210	\$15.74
3318 72111	B. 8" Trimmer, Standard Bow Handle, Curved Blade (Right)	7210C	15.24
3318 72201	C. 9" Trimmer, Large Bow Handle, Straight Blade, Ambidextrous	7220	15.73
3318 75851	9-1/2" X-Large Bow Handle, Straight Blade, Ambidextrous	7240	17.31
3318 72221	D. 9" Trimmer, Large Bow Handle, Curved Blade (Right)	7220C	22.96
3318 72211	E. 9" Trimmer, Large Bow Handle, Curved Blade (Left)	7220CL	22.96
3318 72241	F. 9" Large Bow Handle, No-Slip Bone Break Notch Blade	7220N	16.76
3318 72231	G. 9" Ball Point, Large Bow Handle, Straight Blade	7200BP	16.76
3318 72401	H. 9-1/2" Trimmer, Large Bow Handle, Curved Blade (Right)	7240C	24.47

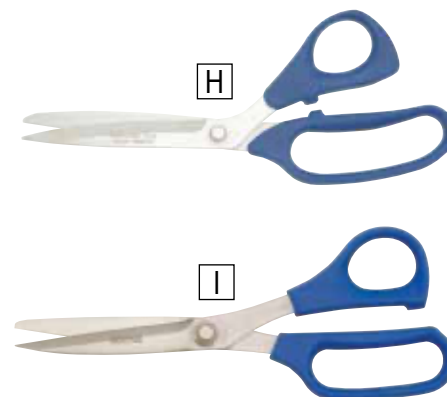

Straight Handle Trimmers

▶ 6 PER BOX.

ITEM NO.	PRODUCT	MFR NO.	EACH
3318 71581	I. 8" Standard Bow Handle, Straight	7158	\$11.03

ComforShear®

Left- and right-handed, color-coded shears offer an exclusive non-slip adjustable pivot system.

- Large poly handles comfortably fit gloved hands.
- Premium-quality stainless blades maintain a sharp cutting edge longer.
- Blade tension preset for cutting poultry.
- Precision heat treated stainless steel blades deliver long life.
- Exclusive non-slip pivot system also allows for adjustment.
- Specially designed thumb area provides ultra comfortable fit.
- Finger opening allows for 3 or 4 fingers to fit comfortably.



Adjustable set screw.

▶ 6 PER BOX.

ITEM NO.	PRODUCT	MFR NO.	EACH
3294 20021	A. 8" Blue, Right-Handed	EG 2002	\$20.95
3294 20001	9-1/2" Blue, Right-Handed	EG 2000	21.95
3294 20011	B. 9-1/2" Green, Left-Handed	EG 2001	21.95



Ultraflex® Handle Shears

Specially hardened stainless steel blades combined with soft, flexible ergonomic Ultraflex® handles for extra strength and comfort!

A./B. Straight Trimmer

- Large, lower bow for gloved hands.

C./D./E. Titanium Bonded™

- Blades are 3 times harder than stainless steel so they stay sharper longer.



▶ 12 PER BOX.

ITEM NO.	PRODUCT	MFR NO.	EACH
2644 43291	A. 9" Bent	18160	\$19.60
2644 30011	B. 8" Straight	15313	19.60
2644 80811	C. 8" Titanium Bonded™, Bent	18081	15.89
2644 80801	D. 9" Titanium Bonded™, Bent	18080	15.89
2644 85171	E. 10" Titanium Bonded™, Bent	18517	23.27



Hot Forged Shears

Claus® hot forged shears are thru-hardened and fully double-plated with chrome over nickel, offering great strength and durability.

- Constructed of cutlery grade steel.
- Large handles accommodate gloved hands.
- Double-plated with chrome over nickel to protect against rust and stains.
- All hot forged shears are thru-hardened.

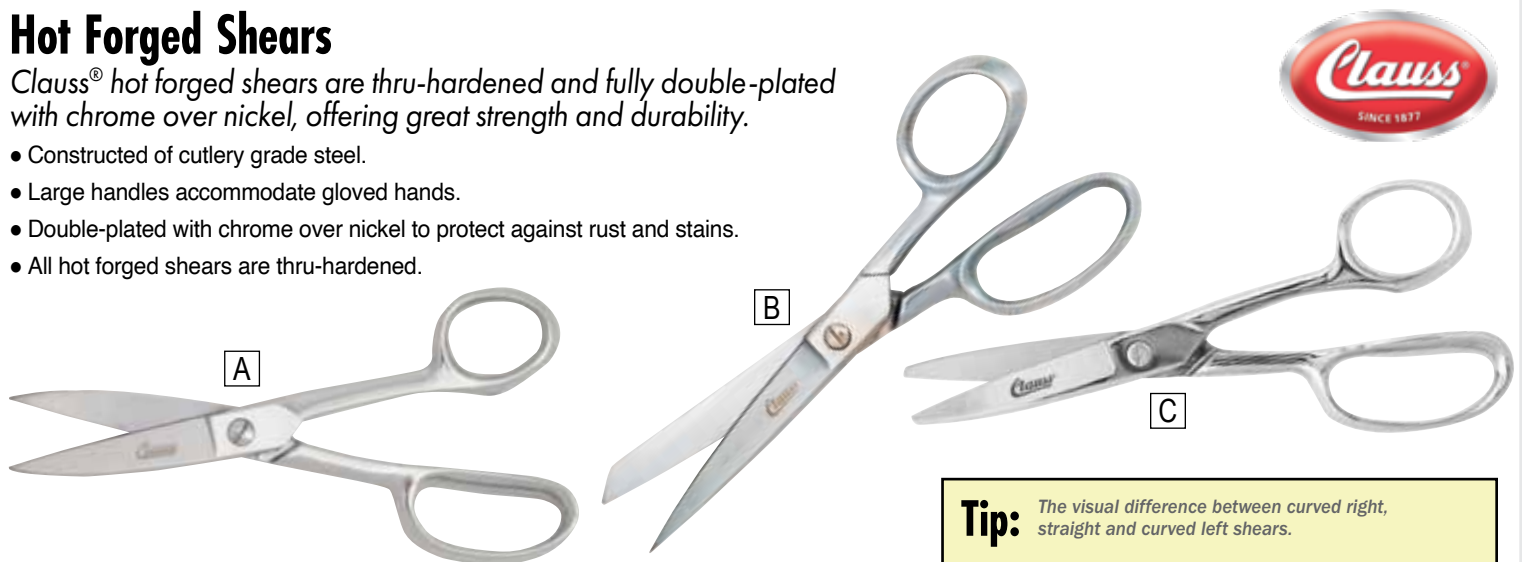

▶ 6 PER BOX.

ITEM NO.	PRODUCT	MFR NO.	EACH
2644 42701	A. 8-1/4" High Leverage, Straight	11200C	\$49.41
2644 13281	B. 8" Right Curved, Straight	10620	40.46
2644 20061	C. 8" Rounded Point, Straight	1120006	51.14

Tip: The visual difference between curved right, straight and curved left shears.

Nylon Handle Poultry Shears

- Stainless steel blades. • Large comfortable ergonomic nylon handles.
- Offset handles and specially contoured thumb hole for firm control.
- Adjustable tension.

▶ 12 PER BOX.

ITEM NO.	PRODUCT	MFR. NO.	EACH
2644 43281	A. 8-1/4" Bent, Ambidextrous	18300	\$25.73
2644 00051	B. 8" Straight	15300	19.60
2644 00061	9" Straight	15400	20.80

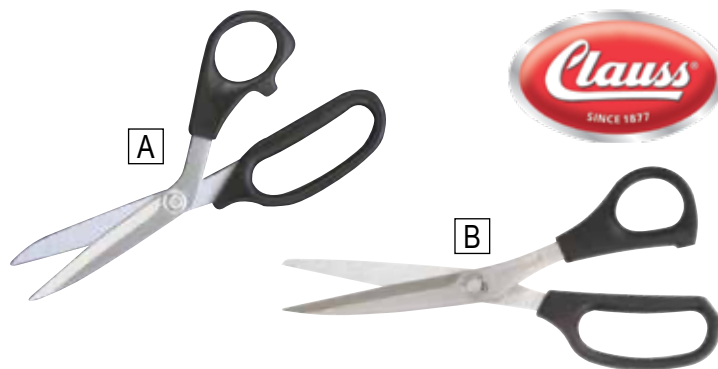

Poultry Processing Shears

- Self-opening design with reversible and replaceable spring for longer product life.
- Innovative, straight top handle design helps reduce fatigue and increase control.
- Through-hardened stainless steel blades for durability and easy cleaning.
- Ambidextrous, soft plastic handles.



Scan this QR code to learn more about this product.



▶ 6 PER BOX.

ITEM NO.	PRODUCT	MFR. NO.	EACH
3318 92091	9-1/4" Bent Handle Shears	7231	\$16.21

Bent Handle Turkey Shears

Big shears for big birds.

- Plastic ambidextrous handles.
- Stainless steel blades. • Cut length: 4-3/4 inches.
- Overall length: 10 inches.

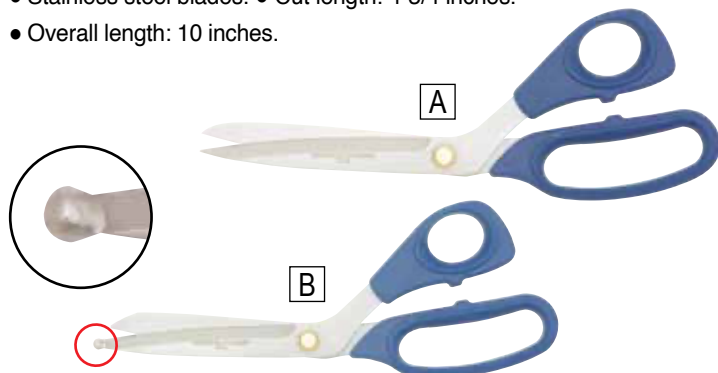

▶ 6 PER BOX.

ITEM NO.	PRODUCT	MFR. NO.	EACH
3318 73101	A. 10" Bent Handle Trimmer	7310	\$17.98
3318 73111	B. 10" Bent Handle Trimmer, Ball Point	7310BP	25.89

Wolff Ergonomix® Poultry Shears

Lasts 2 to 3 times longer than other brands of shears.

- Shears are designed to place the hand in correct alignment for ease of cutting.
- Handles constructed of Santoprene®, a soft thermal rubber that is chemically bonded to the blades to prevent contamination.
- Blades are constructed of AU6 (Aluminum Alloy Die Cast) Japanese stainless steel with Vanadium.

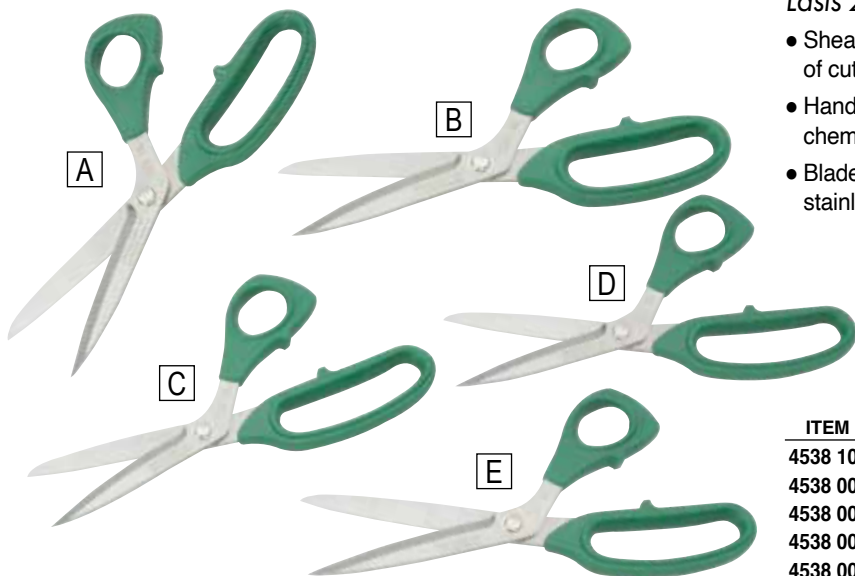

▶ 6 PER BOX.

ITEM NO.	PRODUCT	EACH
4538 10101	A. 8-1/4" Ergonomix®, Straight, Right-Handed	\$25.75
4538 0012	B. 8" Ergonomix®, Curved Right, Right-Handed	27.85
4538 00601	C. 8-3/4" Ergonomix®, Straight, Right-Handed	27.85
4538 00621	D. 8-3/4", Ergonomix®, Curved Right, Right-Handed	27.85
4538 00701	E. 9-1/2" Ergonomix®, Straight, Right-Handed	30.05

Heritage Stainless Steel Poultry Shears

Optional ergo-grip extended handle helps to reduce strain and fatigue.

- Factory hardened, precision ground and properly adjusted blades.
- Power lock screw, keeps trimmers in adjustment. • Hot drop-forged stainless steel.
- Larger handle accommodates four fingers. • Hand-crafted in the USA.



Ergo Grip

▶ 6 PER BOX.

ITEM NO.	PRODUCT	MFR. NO.	EACH
3318 17581	9" Ball Point	758LRBP	\$25.96
3318 02681	8" Ball Point, Bent Down	268LRBP	26.50
3318 07681	8" Blunt Tip, Bent Down.	768LRB	26.86

Standard Grip

▶ 6 PER BOX.

ITEM NO.	PRODUCT	MFR. NO.	EACH
3318 21581	8" Straight Trimmer	158.	\$24.59
3318 07581	8" Ball Point	758BP	24.63
3318 01581	8" Curved Right	158C	34.80
3318 11581	8" Curved Left	158CL	45.18
3318 01591	9" Straight Trimmer	159.	24.57



Pivot moved forward for greater leverage, easier cutting.



Ball-point is forged into shear in its original forging – not soldered, braised or welded.

Chrome-Plated Poultry Shears

- Curved blades for faster trimming of hearts and livers.



A. Ergo Grip

▶ 6 PER BOX.

ITEM NO.	PRODUCT	MFR. NO.	EACH
3318 27181	8" Blunt Tip	718LRB	\$23.10
3318 17181	8" Ball Point	718LRBP	23.07

B. Standard Grip

▶ 6 PER BOX.

ITEM NO.	PRODUCT	MFR. NO.	EACH
3318 21081	8" Straight Trimmer	108.	\$20.12
3318 11081	8" Curved Right	108C	30.94
3318 01131	9" Curved Right	109C	21.86
3318 07181	8" Ball Point	718BP	20.20
3318 01111	10" Straight Trimmer	110.	31.37



A

B



Inside of blades are chrome-plated for glass smooth cutting action and corrosion-resistance.



Fiskars® Shears

- Precision ground blades, permanently riveted resist loosening.
- 9-inch RazorEdge is perfect for large cutting jobs with multiple layers.
- Stainless blades with thermoplastic handles.



▶ 6 PER BOX.

ITEM NO.	PRODUCT	EACH
2182 00041	A. 8" Right Hand Handle	\$14.95
2182 00051	B. 8" Left Hand Handle	15.55
2182 00011	C. 9" Heavy-Duty Handle.	22.85

▶ 3 PER BOX.

ITEM NO.	PRODUCT	EACH
2182 71005	D. 9" RazorEdge, Right Hand Handle.	\$24.95

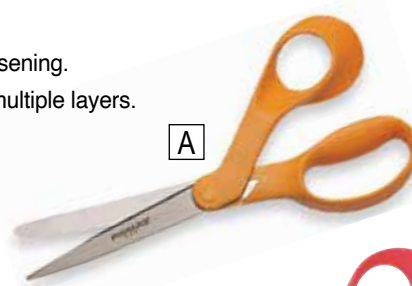

A



C



B



D

INOX PRO® Sharpening Steels

- Molded plastic handle with safety slip guard and ring.
- Corrosion-resistant.
- Available in regular, fine cut or polished steel.

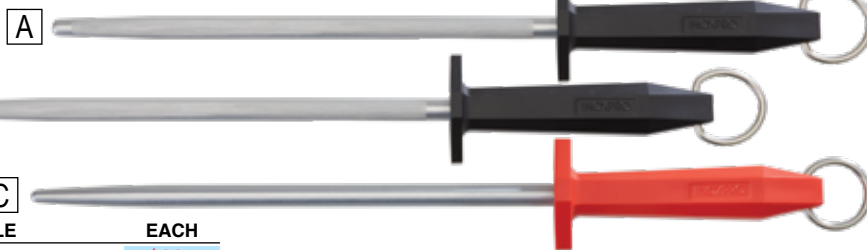

▶ 6 PER BOX.

ITEM NO.	PRODUCT	MFR. NO.	HANDLE	EACH
E542 09121	A. 10" Regular Cut	5210-250IP	Black	\$28.75
E542 09091	B. 10" Fine Cut	5210-255IP	Black	28.75
E542 09101	C. 10" Polished	5325-256IP	Orange	30.75

INOX PRO® steels are crafted in Germany.

Victorinox Round Polished Steels

- Black nylon handle.



VICTORINOX
SWISS ARMY

▶ 6 PER BOX.

ITEM NO.	PRODUCT	MFR. NO.	EACH
3367 00291	10" Round	40583.	\$38.04



Forschner Steels *Compare to the industry's most popular polished butcher steel.*

- Tapered shaft is made of magnetized chromium alloy steel. • Corrosion-resistant.
- Molded plastic handle with guard and chain ring.
- Available in regular, fine or polished cut.



▶ 6 PER BOX.

ITEM NO.	PRODUCT	MFR. NO.	HANDLE	EACH
3367 06871	9" Regular Cut	40687.	Black	\$22.08
3367 05801	10" Regular Cut	40580.	Black	38.04
3367 05811	10" Fine Cut	40581.	Black	38.04
3367 05861	14" Regular Cut	40586.	Black	44.04

▶ 10 PER BOX.

ITEM NO.	PRODUCT	MFR. NO.	HANDLE	EACH
3367 06961	10" Polished.	40696.	Orange	\$17.24



Granton® Polished Packinghouse Steel

The best deal in polished steels.

- 10-inch tapered shaft of hard chromium alloy steel. • Plastic handle with safety slip guard and hang ring.



▶ 6 PER BOX.

ITEM NO.	PRODUCT	MFR. NO.	EACH
3288 01101	10" Polished.	130110.	\$18.35

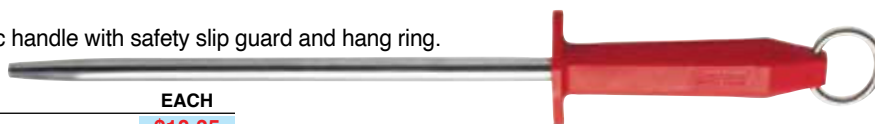

F. Dick Polished Steels

- Plastic handle with safety slip guard and ring. • Tapered shaft made of magnetized chromium alloy steel.
- Corrosion-resistant.

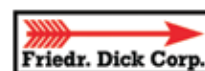

▶ 6 PER BOX.

ITEM NO.	PRODUCT	MFR. NO.	EACH
3186 91251	10" Polished.	7469125.	\$32.95
3186 01251	10" Fine Cut	7470125.	32.95



No Work Steels *No need to dress with emery cloth before use — increasing productivity!*

- Green molded plastic handle with guard and ring. • Available in smooth, coarse or rough cut.



▶ 6 PER BOX.

ITEM NO.	PRODUCT	MFR. NO.	EACH
5816 78201	10" Smooth Cut	07820.	\$28.67
5816 83001	10" Coarse Cut	07830.	28.67
5816 78401	10" Rough Cut	07840.	28.67

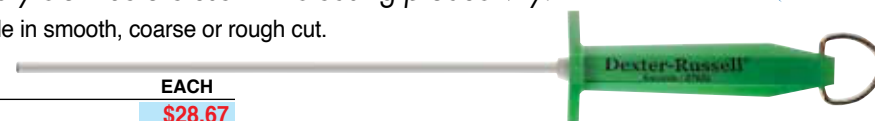

Geno's Custom Low-Maintenance Steels

- 1/4 inch diameter magnetized shaft. • Easily dressed with emery without losing hardness.
- Machined PVC handle with metal hang ring.

▶ 6 PER BOX.

ITEM NO.	PRODUCT	MFR. NO.	EACH
3297 0727	8"	020727	\$40.64
3297 0728	10"	020728	39.14



Smooth Butcher Steel, 10 Inch

- Polished/smooth high-carbon file steel. • Heavy-duty hang ring.
- Black polypropylene handle with guard.

▶ 6 PER BOX.

ITEM NO.	PRODUCT	MFR. NO.	EACH
5816 73131	10" Polished	12SB10	\$36.09



Round Steel, 10 Inch

- Round/Regular cut. • Black poly handle with hang ring.

▶ 6 PER BOX.

ITEM NO.	PRODUCT	MFR. NO.	EACH
4894 03101	10" Regular Cut	330310	\$25.90



Edgemaster SXL Sharpening Steel

- High-carbon, stain-free steel with special hardening for longer wear-life.
- Custom black textured polypropylene handle with guard and ring. • 1/2 inch diameter.

▶ 6 PER BOX.

ITEM NO.	PRODUCT	MFR. NO.	EACH
5816 73631	14" Coarse	07363	\$52.31



Sheffield Combination Steels

- Combination-cut steel: half fine cut, half polished. • Molded nylon handle with guard and ring.

▶ 6 PER BOX.

ITEM NO.	PRODUCT	MFR. NO.	EACH
3367 05821	10"	40582	\$38.04
3367 05851	12"	40585	40.72



F. Dick Regular Cut Steel

- Chromium alloy steel for longer wear and corrosion-resistance. • Regular cut steel.
- Molded plastic handle with guard and chain ring.

▶ 6 PER BOX.

ITEM NO.	PRODUCT	MFR. NO.	EACH
3186 71251	10"	7517125	\$36.25



F. Dick Wood Handle Packinghouse Steels

- Chromium alloy steel for longer wear and corrosion-resistance. • Regular cut. • Diamond shaped guard.
- Wooden handle with guard and ring.



▶ 6 PER BOX.

ITEM NO.	PRODUCT	MFR. NO.	EACH
3186 01711	12".....	7171130.....	\$63.75



F. Dick Round Chrome Steel

- Regular cut — regular serrations. • Balanced taper towards the tip of the steel. • Hard chrome plating.



▶ 6 PER BOX.

ITEM NO.	PRODUCT	MFR. NO.	EACH
3186 00121	12".....	7655130.....	\$54.95
3186 06551	14".....	7655135.....	60.45

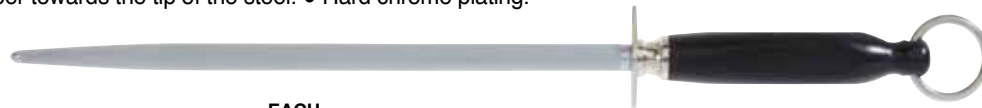

High-Carbon Serrated Butcher Steel

- High-carbon — chrome vanadium. • Medium coarse — serrated cut. • Diamond shaped guard.
- Rosewood handle with ring. • 5/8 inch diameter.



DEXTER

▶ 6 PER BOX.

ITEM NO.	PRODUCT	MFR. NO.	EACH
5816 70301	12".....	07030.....	\$53.58
5816 70601	14".....	07060.....	56.13



Geno's Low-Maintenance Ceramic Sharpener

- 5/16 inch diameter ceramic shaft. • Light-weight and easy to handle.
- Machined PVC handle with metal hang ring.

▶ 6 PER BOX.

ITEM NO.	PRODUCT	MFR. NO.	EACH
3297 0729	8".....	020729.....	\$47.39



Ceramic Sharpener

- 1/2 inch diameter aluminum oxide, ceramic shaft. • Ebony plastic molded handle.



DEXTER

▶ 6 PER BOX.

ITEM NO.	PRODUCT	MFR. NO.	EACH
5816 70101	8".....	07010.....	\$69.80
5816 70201	10".....	07020.....	77.33
5816 45261	12".....	07050.....	92.27



Granton[®] Square Steel *Two sides polished/two sides dressed.*

- Magnetized, hard chrome shaft, 5/16 inch square x 10 inches long.
- Plastic handle with metal hang ring.

Granton[®]

▶ 6 PER BOX.

ITEM NO.	PRODUCT	MFR. NO.	EACH
3288 21001	10".....	62100R.....	\$41.75



INOX PRO® Trimmer Steel

- Available in 7-1/2 inch and 5 inch regular cut.
- White nylon handle with guard and ring.

▶ 6 PER BOX.

ITEM NO.	PRODUCT	MFR. NO.	EACH
E542 09111	A. 5".....	5215-150IP	\$14.50
E542 08821	B. 7-1/2".....	5215-200IP	17.50



INOX PRO
CUTLERY

INOX PRO® steels are crafted in Germany.

F. Dick Multi-Cut Steel

- Honed the knife with both coarse and fine surfaces.
- Plastic handle, hard-chromed shaft.
- Extra-wide oval shaft with seven cutting grooves.

▶ 6 PER BOX.

ITEM NO.	PRODUCT	MFR. NO.	EACH
3186 90111	11".....	7650428	\$142.95



Friedr. Dick Corp.

Trimmer Steels

- Available in 5 inch and 7-1/2 inch regular cut.
- White nylon handle with guard and ring.

▶ 6 PER BOX.

ITEM NO.	PRODUCT	MFR. NO.	EACH
3367 06411	5".....	40589	\$19.54
3367 06801	7".....	40680	22.96



VICTORINOX
SWISS ARMY

F. Dick Poliron Steel with 2k Handle, 10 Inch

- Chromium alloy steel for longer wear and corrosion-resistance.
- Extra-wide polished oval shaft fine cut.
- Slip-proof surface, even when wet or greasy.
- Hygienic and safe to meet food regulation requirements.
- Ergonomic handle with distinct finger guard and hole for chain.

▶ 6 PER BOX.

ITEM NO.	PRODUCT	MFR. NO.	EACH
3186 98101	10".....	7389325	\$81.35

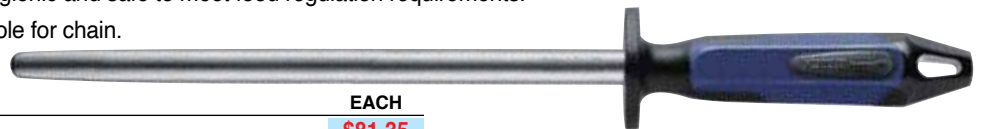

Friedr. Dick Corp.

Diamond Sharpening Steels

- Sharp diamond tips exposed on a broad bi-curved surface.
- Restores knife edges quickly, with just a few strokes.

▶ 6 PER BOX.

ITEM NO.	PRODUCT	MFR. NO.	EACH
4894 00101	10".....	SC3311-10	\$37.65
4894 00121	12".....	SC3311-12	62.72



MUNDIAL

EZE-Lap Diamond Steel

- Unlike ordinary steels, the EZE-Lap removes metal, reduces grinding and honing.
- Sharpens in 30 seconds.
- Coated with 50-million diamond cutting edges.

▶ 6 PER BOX.

ITEM NO.	PRODUCT	MFR. NO.	EACH
3054 21661	10".....	P-PL	\$55.90

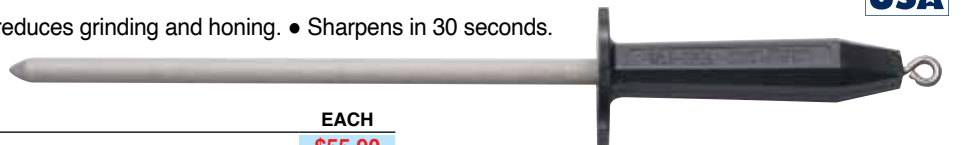

MADE IN
USA

DMT Diamond Steel

- Coated with diamond crystals.
- Non-porous, nickel-plated metal core is sanitary and rust-free.

▶ 6 PER BOX.

ITEM NO.	PRODUCT	MFR. NO.	EACH
3545 00021	12".....	DS2F	\$53.85



MADE IN
USA

Cloth-Backed Emery Rolls

- Aluminum Oxide cloth rolls are used for fast and easy sanding where flexibility and tear-resistance are important.
- Cloth-backed for increased strength and durability.
- 1 inch x 50 yard sizes with various grit options.



► 5 ROLLS PER SHRINK WRAPPED PACK.

ITEM NO.	GRIT
4808 62671	400
4808 62681	320
4808 62711	220
4808 62721	180
4808 62741	120
4808 62761	80

ROLL	EACH
	\$42.67

Fiskars® Scissors Sharpener FISKARS®

Restores scissors blades to the perfect cutting edge.

- Automatically adjusts to sharpen different blade grinds safely.
- Two slots ensure proper positioning for optimal blade sharpening.
- Sharpens right- and left-handed scissors.
- Light-weight, compact design for easy storage and transportation.
- Finger indentations offer a comfortable, secure grip when sharpening.
- Not for use with pinking shears or scissors with serrated blades.



ITEM NO.	PRODUCT	EACH
2182 00021	Scissors Sharpener	\$15.55

Handheld Sharpeners

- Two or three passes is sufficient to sharpen blade.
- Carbide blade will not rust; clean with soap and water.
- Large handle fits either hand and its full length guard protects fingers.



NOTE: Colors are random and may NOT be specified.



► 6 PER BOX.

ITEM NO.	PRODUCT	EACH
4808 75201	Knife/Scissor Sharpener	\$19.29

X-Sharp Knife Sharpener



- Allows for edge retrieval as well as sharpening on-line.
- Designed for versatility — may be handheld or mounted.
- Design allows for incredibly sharp edges while promoting ergonomic health.
- The most durable sharpener on the market today.
- Mounting bracket included.



Sharpener can be positioned at best angle for sharpening.



ITEM NO.	PRODUCT	EACH
3523 2202	White, 23"	\$68.56
3523 0227	Blue, 27"	68.56

PrimeEdge Mouse Trap Stainless Steel Sharpeners

Maintain the performance of cutting edges throughout your plant.

- Three alignment rods ensure perfect sharpening alignment of any length knife edge, from base to tip.
- Wider entrance design guides knife blades perfectly into alignment rods while avoiding contact with base.
- Enhanced durability with longer-than-ever spring life.
- Lighter than ever for ease of hand-held operation.
- Electropolished finish to reduce contamination build-up.

ITEM NO.	PRODUCT	DIMENSIONS	EACH
3192 00411	A. Table Mounted Sharpener	7-3/8" x 5-3/4" x 1-1/8"	150.95
3192 00401	B. Hand-Held Sharpener	11-1/2" x 5-3/4" x 2-1/4"	150.95
3192 32251	C. Mounting Bracket		11.52

PRIMEEdge
COZZINI CUTTING EDGES
AND SHARPENING SOLUTIONS



A

Optional bracket allows for hand-held version to be table mounted.

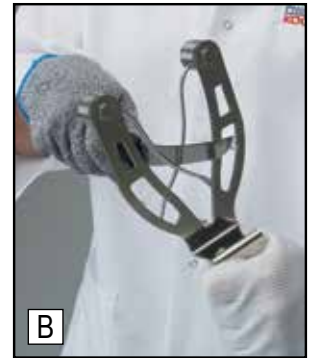

B



C

Ergo Steel II Knife Sharpener

Easy, strain-free knife-edge maintenance.

- Attaches easily to most surfaces.
- Three spring-loaded separate stainless steel edging elements for a smooth controlled stroke.
- Metal protectors allow knife to slip into sharpener without damaging plastic base.
- Optional handle or base for greater support while sharpening. Can also be mounted to a table or other surface.
- Can be used by either right- or left-handed operators.

NOTE: Available in blue or yellow. Call for more information.

PRIMEEdge
COZZINI CUTTING EDGES
AND SHARPENING SOLUTIONS



Optional handle.



Surface mount.

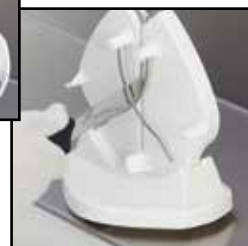

Optional base.

NOTE: Mounting hardware sold separately. SEE BELOW.



ITEM NO.	PRODUCT	DIMENSIONS	EACH
3192 00051	White Sharpener	7-1/4" x 1-3/5" x 7-1/2"	\$94.55
3192 0022	Handle w/Hardware		46.01
3192 10021	Base w/Suction Cups		20.48

Ergo Steel III Knife Sharpener

Get the perfect edge in seconds.

- Totally enclosed, sanitary spring mechanisms.
- Aligns both sides of the blade simultaneously.
- Straightens and prolongs the edge life knives.
- Ideal of all types of small and large knives.
- Safety shield handle provides comfortable and safe, right or left handed use.
- Easy maintenance and cleaning.
- USDA and CE approved.

PRIMEEdge
COZZINI CUTTING EDGES
AND SHARPENING SOLUTIONS



Hand held.



Mounted to table.



NOTE: Available in blue or yellow. Call for more information.

NOTE: Mounting hardware sold separately. SEE BELOW.

ITEM NO.	PRODUCT	DIMENSIONS	EACH
3192 10031	White Sharpener	7" x 4" x 12"	\$93.50
3192 32251	Mounting Bracket		11.52

Hand-Held Knife Sharpening System

Especially designed for meat processing or food preparation lines.

- A few quick strokes will return your knife to peak performance.
- Straightens and prolongs the edge life of hand knives.
- All in one design includes honing rod and alignment elements.
- USDA and CE certified.

PRIMEEdge[®]
COZZINI CUTTING EDGES
AND SHARPENING SOLUTIONS

MADE IN
USA

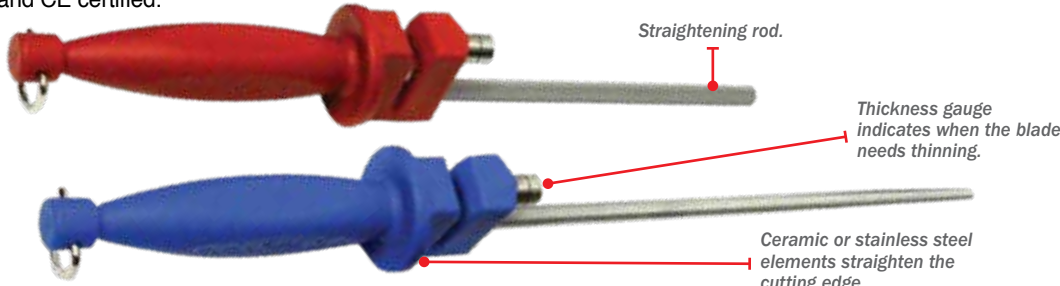

ITEM NO.	ALIGNING ELEMENT	TEXTURE	COLOR	LENGTH	EACH
3192 00011	Hand-Held, Stainless Steel	Coarse	Blue	6-1/2"	\$57.78
3192 00021	Hand-Held, Ceramic	Coarse	Red	6-1/2"	57.78
3192 10051	Hand-Held, Stainless Steel	Smooth	Blue	10-1/5"	75.17
3192 10061	Hand-Held, Ceramic	Smooth	Red	10-1/5"	75.17

3-Way Knife Sharpener

Features three, 12-inch ceramic rods, each with a different coarseness, to improve the blade's edge. The 3-way flips over to give you the appropriate coarseness for the job.

- To keep a sharp knife sharp, use only the white rod.
- No oil or water necessary when sharpening.
- Ceramic rods improve with use.
- For a dull or worn edge, use the brown rod and final hone with the white rod.
- For partially dull edge, use the gray rod and final hone with the white rod.

DEXTER



ITEM NO.	PRODUCT	EACH
5816 0276	3-Way Knife Sharpener	\$105.95
5816 7409	Coarse Replacement Rod, Brown	14.88
5816 7419	Medium Replacement Rod, Gray	14.88
5816 7429	Fine Replacement Rod, White	14.88



Use sharpener standing upright or laying flat on a solid surface.



Sharp'Easy Knife Sharpener

- Sharpener can be mounted at either a 90° angle on a table or a 45° angle on a post. Mounting bracket included.
- Stainless steel pre-tensioned guide bars have been specially treated to ensure longevity and low maintenance cost.
- Sharpener can be easily removed from its stainless steel mounting so that it can be cleaned and sterilized.



Can be mounted on a table or hand-held.



Table-Mount Sharpener

Sharpens both edges of blade.

- Dual edge sharpener allows both blade edges to be sharpened simultaneously.

NOTE: Mounting hardware NOT INCLUDED.

MADE IN
USA



NOTE: Mounting bolts NOT INCLUDED.

ITEM NO.	PRODUCT	DIMENSIONS	EACH
6360 0008	Knife Sharpener w/Stand	5-1/4" x 3-3/4" x 11"	\$139.35
6360 13361	Replacement Blade Guard		39.95
6360 13371	Replacement Sharpening/Tension Bar		20.35

ITEM NO.	PRODUCT	EACH
3523 24001	Table-Mount Sharpener	\$118.95

EV05 Knife Sharpening Machine

Robust and reliable for sharpening a wide variety of cutting tools.

- Grinding angle is adjustable from 20° to 50°.
- Magnetic knife guides ensure that knives are always ground with the correct cutting edge angle.
- The polishing disk produces fine, polished surfaces and a burr-free, very smooth cutting edge.
- Dirt-resistant membrane pump conveys the cooling water to the grinding unit. The cutting edges cannot be overheated during grinding. The grinding abrasion collects in the water tray. A magnetic bar separates the dirty area from the clean area preventing the grinding abrasion from re-entering the coolant circuit.

KNECHT

POWER SHARPENERS



Sharpen knives on wet grinding wheel at any angle.



Deburr and polish.



Water tray into dirty and clear areas by magnetic bar.



Magnetic bar collects dirty abrasion in water tray.



Dirt tray with suction socket, use to connect to vacuum.

ITEM NO.	PRODUCT	MFR. NO.	EACH
M317 00011	Sharpening System	014EVO-5	\$6,500.00
M317 00021	Vacuum NT30 110V.....	EV054NT300001	625.00
M317 00031	Grinding Disks (10/Box)	412B-00-0020	270.00
M317 00051	Polishing Wheel.....	412Z-01-0010	79.50

X-Tra Edge Sharpener

Grind and hone on the same machine.

- Sharpener is now belt driven for a smooth, quiet performance.
- Sharpens on left side — hones/polishes on right side.
- Dry grinder wheels are fully adjustable. • All operations performed dry.
- Accepts any length knife. • Easy-to-service, simply turn stones for even wear.
- Aluminum housing with vibration absorbing rubber feet.
- Weight: 22 pounds. • 110 V 3-prong plug; 5-foot grounded power cord.



FREE pair of hollow grinding stones with each unit.



FREE Truing Stick with each unit.



ITEM NO.	PRODUCT	DIMENSIONS	EACH
3363 9600	X-tra Edge Sharpener	16" x 8" x 8"	\$1,099.99
3363 9013	2 Replacement Sharpening Stones (100 Grit)		56.23
3363 9014	2 Replacement Honing Stones (220 Grit)		56.23

Commercial Power Sharpener

Unique double overlapping sharpening wheels assure edge angle accuracy.

- Stainless steel table stand, 2 extra drive belts, 1 belt tool with each unit and a 6-foot cord.
- Reduce sharpening time — both sides of blade are ground at same time.
- Extends life of knives by removing as little knife material as possible.
- Knife blade enclosure covers blade for safety during sharpening.
- Stainless Steel Housing: 12 inches L x 8 inches D x 5-1/2 inches H.



ITEM NO.	PRODUCT	F.O.B. FACTORY EACH
5988 0003	Light-Duty Commercial Sharpener	\$1,768.49
5988 02201	Replacement Wheel 220 Grit (Fine) (Set of 2 Wheels)	77.40
5988 59741	Replacement Wheel 100 Grit (Medium) (Set of 2 Wheels)	76.97

F. DICK RS75 Power Steel Sharpener

- No training necessary, no adjustments to make, simply pass knife a few times between the wheels for perfect sharpness.
- Ease of use allows for continuous all-day sharpening, reduces fatigue and increases worker productivity.
- Heavy-duty plastic housing is easy-to-clean, comes with vibration absorbing rubber feet and a 9-foot power cord.
- High-speed, counter-rotating wheels produce the same sharp edge every time.
- 110 V.



ITEM NO.	PRODUCT	DIMENSIONS	F.O.B. FACTORY EACH
3186 0075	X-tra Edge Sharpener	9" x 7-1/4" x 6-1/2"	\$659.95
3186 5021	2 Replacement Sharpening Stones (100 Grit)		139.95

Replacement Hook-Eye Grinder Belts

- When grinding, these belts reduce heat and create exceptional edge.
- Constructed of aluminum oxide with cloth back.
- Size: 24 inches L x 1-1/2 inches W. • 80 grit.



ITEM NO.	PRODUCT	BOX
4808 5072	Box of 10 Belts	\$26.10

Chef'sChoice® EdgeSelect-Pro™ Diamond Hone® Knife Sharpener

Rugged and built to perform.

- Ideal for 20 degree class knives. • Precision angle guides, easy-to-use.
- Extremely fast, diamond abrasives for superb sharpness.
- 3-Stages, create triple-bevel arch-shaped edge. • NSF certified.
- Sharpens straight edge and serrated knives.
- Dimensions: 10 inches L x 4-1/4 H x 4-1/4 inches D.



ITEM NO.	PRODUCT	EACH
5989 00081	EdgeSelect-Pro™ Sharpener	\$377.95

Chef'sChoice® Heavy-Duty Diamond Hone® Sharpener

Edges stay sharp up to 3 times longer!

- Three-stage sharpener creates 3 bevels for an even stronger edge.
- Patented diamond and stropping disks will not detemper blades.
- Built-in guide system takes guesswork out of maintaining proper angles.
- Sharpens all types of straight edge, serrated knives and cutting tools.
- Dimensions: 12 inches L x 5 inches H x 5 inches D.



Sharpening cartridges can be easily removed and cleaned in a dishwasher.



ITEM NO.	PRODUCT	EACH
5989 10081	Diamond Hone® Sharpener	\$727.80
5989 10091	Replacement Sharpening Module	169.00
5989 13001	15° Angle Sharpening Module	169.00

SHOP 24/7
bunzlpd.com



Need Help?
 Chat With Us
 Online!

STAY CONNECTED WITH US:



Where you can find out what's on sale, find updated product information, reviews and pricing.



IM200 Sharpening System

The 8-inch version of the IM313 — the same quality sharpening features in a smaller package.



Set includes:

Oilstone Holder Base

Dust Cover

Pint of Oil

Coarse-grit Crystolon®

Medium-grit Crystolon®

Fine-grit India Stone

ITEM NO.	PRODUCT	DIMENSIONS	EACH
4808 1260	IM200 Oilstone Sharpener Set		\$167.26
4808 45711	Coarse Grit Replacement Stone	8" x 2" x 2/5"	33.50
4808 45761	Medium Grit Replacement Stone	8" x 2" x 2/5"	33.50
4808 45721	Fine Grit Replacement Stone	8" x 2" x 2/5"	33.50

IM313 Multi Oilstone Set

Ideal for general sharpening and honing large straight edge knives and tools.

- Non-skid base serves as an oil reservoir in which stones may be immersed when not in use.

Set includes:

Oilstone Holder Base

Coarse-grit Crystolon®

Dust Cover

Medium-grit Crystolon®

Pint of Mineral Oil

Fine-grit India Stone



ITEM NO.	PRODUCT	DIMENSIONS	EACH
4808 0313	Multi Oilstone Sharpener Set		\$330.46
4808 10031	Coarse/Fine Stone	11-1/2" x 2-1/2" x 1/2"	54.84
4808 10061	Medium Grit Replacement Stone	11-1/2" x 2-1/2" x 1/2"	54.84
4808 00091	Fine Grit Replacement Stone	11-1/2" x 2-1/2" x 1/2"	54.84
4808 10021	Mineral Oil, 1 qt.		28.55

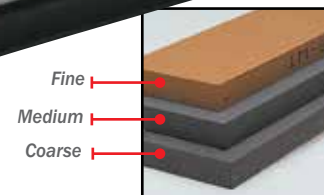

IM83 Portable Oilstone Sharpening System

All-in-one sharpening system, a convenient way to sharpen knives anywhere.

- Base unit contains a built-in reservoir and keeps the stones clean and ready to use.
- A simple rotation of the handle brings the desired stone into position for sharpening.
- Removable storage caddy for knives and tools.

Set includes:

Plastic Case w/

Removable Tool Caddy

4.5-ounce Can of Oil

Coarse-grit Crystolon®

Medium-grit Crystolon®

Fine-grit India Stone



Rugged Design:
Durable plastic case,
sturdy metal latches
and non-skid feet.



Stones are changed individually and locked into place.



Rotating handle with built-in reservoir.

Removable Tool Caddy:
Roomy storage for tools for maximum portability.

ITEM NO.	PRODUCT	DIMENSIONS	EACH
4808 28231	IM83 Oilstone Sharpener Set		\$248.86
4808 44591	Coarse Grit Replacement Stone	8" x 3" x 1/2"	31.19
4808 44581	Medium Grit Replacement Stone	8" x 3" x 1/2"	31.19
4808 44601	Fine Grit Replacement Stone	8" x 3" x 1/2"	31.19

Gasket on inside of lid keeps oil from leaking while transporting.





Sharpening Mineral Oil

- Meets USDA standards for use around food.
- Refined specifically for sharpening.
- 1 quart.

ITEM NO.	PRODUCT	EACH
4808 10021	Mineral Oil, 1 qt.	\$28.55

FJB8 Fine Bench Oil Stone

- Crystolon for sharpening of cutting tools and shaping edge.

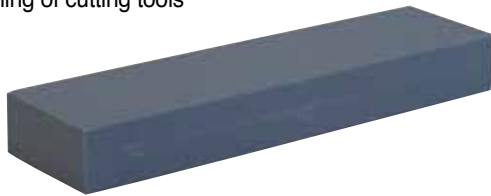

ITEM NO.	PRODUCT	DIMENSIONS	EACH
4808 00121	FJB8 Fine Stone	.8" x 2" x 1"	\$37.62

Super Fine Crystolon Oil Stone

- 400-grit stone for super fine sharpening.

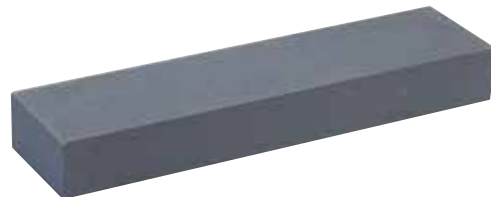

ITEM NO.	PRODUCT	DIMENSIONS	EACH
4808 0222	400-Grit Stone	.8" x 2" x 1"	\$40.24

IM100 Sharpening System

The 6-inch version of the IM313 — the affordable choice for small knives, cutlery and woodworking tools.

Set includes:

- Oilstone Holder Base
- Dust Cover
- Pint of Oil
- Coarse-grit Crystolon®
- Medium-grit Crystolon®
- Fine-grit India Stone

ITEM NO.	PRODUCT	DIMENSIONS	EACH
4808 53561	IM100 Oilstone Sharpener Set		\$142.81
4808 53521	Coarse Grit Replacement Stone	.8" x 2" x 2/5"	20.78
4808 53501	Medium Grit Replacement Stone	.8" x 2" x 2/5"	20.78
4808 53481	Fine Grit Replacement Stone	.8" x 2" x 2/5"	20.78

Combination Stone



- Aluminum oxide combination stone: one side coarse grit and the other side fine grit.

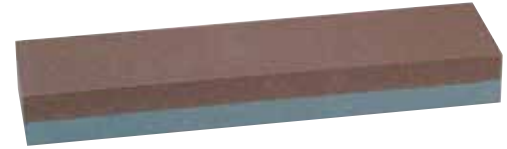

ITEM NO.	PRODUCT	DIMENSIONS	EACH
4808 00081	Coarse/Fine Stone	.8" x 2" x 1"	\$20.90

IB8 Fine/Coarse India Combination Stone

- 100-grit on one face for repairing steel cutting edges and 320-grit on the opposite face for sharpening and maintaining them.



ITEM NO.	PRODUCT	DIMENSIONS	EACH
4808 00111	IB8 Fine/Coarse Stone	.8" x 2" x 1"	\$42.11

IC6 Medium/Fine Crystolon/India Stone

- Crystolon/India combination produces strong, long-lasting, keen edges on tools.



ITEM NO.	PRODUCT	DIMENSIONS	EACH
4808 2006	IC6 Medium/Fine Stone	.8" x 2" x 1"	\$52.97



FISKARS®

Cuts+More™ Scissors

These are not your average scissors!

- Fully hardened, precision-ground steel blades stay sharp, even when cutting a wide range of heavy-duty materials.
- Ergonomically sculpted handles provide comfortable use and cutting control.
- Pointed awl tip is perfect for piercing small holes in cardboard, leather, etc.
- Dishwasher safe for easy cleaning. • Power notch cuts light rope.
- Wire cutter makes it easy to cut wire without damaging the blades.
- Bottle opener makes it easy to open your favorite beverage.
- Sheath protects blades, sharpens scissors and includes a tape cutter for opening boxes.
- Scissors can be taken apart and used as a titanium-enhanced knife that is ideal for cutting large or awkward objects.



Sharp enough to easily cut through poultry.



Includes sheath with built-in sharpener.



Breaks apart to use one side as a knife.



Built-in wire cutter.



Built-in twine cutter.



Handy bottle opener.



Built-in box/tape cutter.

ITEM NO.	PRODUCT	EACH
2182 57101	Cuts+More™ Shears, 9" Length	\$18.85

Twine Knives

Stainless steel finger twine knife lets you tie and cut in one motion.

- 8 sizes to fit most any finger.
- 1/2-inch cutter blade (non-resharpenable).

▶ SEE PAGE 591
For Twine and Twine Holder

ITEM NO.	PRODUCT	SIZE (DIA.)
4804 30081	#8	23/32" Dia.
4804 30091	#9	3/4" Dia.
4804 30101	#10	25/32" Dia.
4804 30111	#11	13/16" Dia.
4804 30121	#12	27/32" Dia.
4804 30131	#13	7/8" Dia.
4804 30141	#14	29/32" Dia.
4804 30151	#15	30/32" Dia.



▶ 12 PER CASE.

EACH

\$2.65



Watch a short video to see everything the Cuts+More scissors can do!

Viper® PRO Multi-Purpose Tool

- Replaces unsafe tools such as scissors, utility knives and box cutters.
- Minimizes cross-contamination, which causes foodborne illness.
- Stainless steel blade resists corrosion and breakage.
- Easy to clean, dishwasher and sanitizer safe.
- Ergonomically designed for ease of use.
- FDA compliant, food-safe materials.



▶ 6 PER BOX.

ITEM NO.	PRODUCT	BOX
1156 00055	Viper® PRO Multi-Purpose Tool	\$35.08

Viper® Safety Bag and Pouch Opener

- Minimizes cross-contamination, which causes foodborne illness.
- Reduces injuries associated with loose blades in the workplace.
- Stainless steel blade resists corrosion and breakage.
- Easy to clean, dishwasher and sanitizer safe.
- Ergonomically designed for ease of use.
- FDA compliant, food-safe materials.



ITEM NO.	PRODUCT	EACH
1156 21011	Viper® Safety Bag and Pouch Opener	\$3.95

Compact Self-Retracting Safety Knife



- Spring-activated blade automatically retracts when you take your thumb off the slider.
- Symmetrically shaped, high-impact ABS handle.
- Stainless steel blade channel. • Convenient lanyard hole.
- Preloaded with an SKB-7 safety blade.



ITEM NO.	PRODUCT	MFR. NO.	EACH
3078 00411	Self-Retracting Safety Knife.	SK-7.	\$9.65
3078 00475	Replacement Blades (10/Pack).	SKB-7/10B.	7.35

Self-Retracting Safety Knife



- Spring-retractable safety cutter.
- Automatically retracts the instant the blade loses contact with the cutting surface and the thumb is not on the blade slide.
- Slip-resistant ergonomic handle. • Stainless steel blade channel.
- Ambidextrous handle — for right and left handed use.
- Tool free blade change.



ITEM NO.	PRODUCT	MFR. NO.	EACH
3078 00371	Self-Retracting Safety Knife.	SK-4.	\$10.55
3078 00465	Trapezoid Blades (10/Pack)	SKB-2	8.65
3078 00455	Rounded Tip Blades (10/Pack).	RSKB-2/10B.	8.65

Rubber Grip Utility Knife



- Multi-position blade slide. • Anti-slip cushion grip for exceptional comfort and safety. • Easy, no-tool blade change.
- Heavy-gauge stainless steel blade channel that holds blade tight. • Chemical resistant for easy cleaning.
- Highest-grade carbon tool steel snap blades for sharpness and durability.

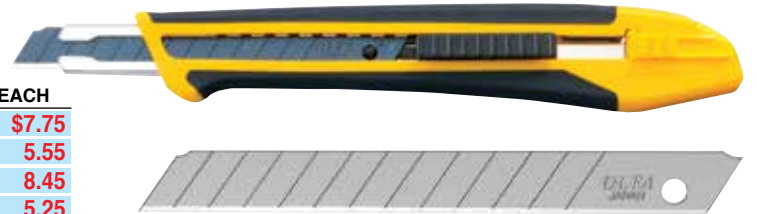

ITEM NO.	PRODUCT	MFR. NO.	EACH
3078 00391	Rubber Grip Utility Knife	XA-1.	\$7.75
3078 00425	9 mm Snap-Off Replacement Blades (5/Pack)	AB-5B	5.55
3078 00435	9 mm UltraSharp, Snap-Off Blades (10/Pack)	ABB-10B	8.45
3078 00445	9 mm Solid Replacement Blades (10/Pack)	A-SOL-10B	5.25

Orange Utility Knife with Sheath

- 1-1/2-inch stainless steel Sheepfoot full tang blade.
- Easy to resharpen blade edge for a long service life.
- Both knife and sheath can be autoclaved and chemically sterilized.
- Includes a plastic break-away safety sheath to hook onto belt for convenient access.



ITEM NO.	PRODUCT	EACH
F270 18431	Orange Utility Knife/Sheath.	\$35.35

Economy Razor Knife

- Low cost option for box opening and general utility.
- Sliding sleeve covers blade when not in use.
- Uses common single-edged razor blades.



▶ 12 KNIVES PER BOX.

ITEM NO.	PRODUCT	BOX
5415 90481	Razor Knife (Dozen/Box).	\$5.95
1060 97045	Replacement Blades (100/Box)	12.49

Economy Carton Cutter Knife



- Polypropylene acetone-resistant blade holder.
- Sliding stainless steel sleeve covers blade when not in use.
- Uses snap-off, CTB, 6-segment replacement blades.
- Carbon steel handle.



▶ 40 KNIVES PER PACK.

ITEM NO.	PRODUCT	MFR. NO.	PACK
3078 00405	Carton Cutter Knife (40/Pack)	CTN-1	\$114.35
3078 00495	Replacement Blades (5/Pack).	CTB	5.65

Stainless Steel Metal Detectable Safety Knife

A safety cutting solution that meets the demands of a food processing environment.

- Spring-activated blade retracts when lifted from the cutting surface.
- Easy to clean and sanitize.
- Metal detectable blade and components.

OLFA®

NSF

ITEM NO.	PRODUCT	MFR. NO.	EACH
3078 00561	Stainless Steel Self-Retracting Safety Knife	SK-14	\$21.15
3078 00215	Pointed Tip Replacement Blades (10/Pack)	SKB-2S	8.65
3078 00575	Rounded Tip Replacement Blades (10-Pack)	SKB-2S-R	8.65

SmartGrip™ Snap Off Blade Knife

- Retractable blade, breaks off in sections exposing a new sharp tip.
- Ergonomic handle design to fit comfortable in hand.

MADE IN USA

ITEM NO.	PRODUCT	EACH
1060 00011	Blade Knife (Includes 3 Blades)	\$6.95

MADE IN USA

Handy blade dispenser available in boxes of 100.



ITEM NO.	PRODUCT	EACH
3106 4040	Retractable Safety Knife	\$11.89
1060 02405	Replacement Blades (Dispenser Box of 100)	16.42

Quickblade® Autoloading Utility Knife

Easy-to-use slider knob automatically loads new blade.

- All metal construction with a one-piece hinge design contains no loose parts.
- Ergonomic rubber handle for secure grip.
- Quick and safe blade change without the use of tools.
- 5 blades included with knife — box of 100 replacement blades available.

▶ 10 KNIVES PER CASE.

ITEM NO.	PRODUCT	EACH
5415 03751	Autoload Knife	\$9.95
5415 00925	Replacement Blades (Box of 100)	14.95



Remove old blade, push slider and automatically load new blade.



Push button to use other side of current blade.



Side-loading blade chamber allows for 5 blades to be stored inside the knife at one time.

Adjustable Utility Knife

- Store extra blades in the handle.
- Retractable blade can be set to two depths or completely retracted for transport.

MADE IN USA

▶ 36 KNIVES PER CASE.

ITEM NO.	PRODUCT	EACH
1060 03301	Utility Knife	\$6.61
5415 00925	Replacement Blades (Box of 100)	14.95

Handy Hooker Plastic Wrap Knife

Designed to safely cut film, banding and pallet strapping.

- Quick blade change with the push of a finger.
- Double-honed, single-edge blade.
- Steel head and blade cartridge.
- Impact-resistant handle.



ITEM NO.	PRODUCT	EACH
5415 07001	Handy Hooker Knife	\$7.95

Concealed Blade Safety Knife

Safely cut through packaging materials, shrink wrap, plastic, film, nylon and more.

- Durable, heavy-duty impact-resistant plastic.
- Multi-point blade positioning. • Stainless steel replaceable blade.



ITEM NO.	PRODUCT	MFR. NO.	EACH
3078 00271	Concealed Blade Safety Knife	SK-10	\$11.65
3078 00485	Replacement Blades (10/Pack).	SKB-10	6.65

“Fish” Safety Knife

Suitable for use with strapping, cardboard, stretch wrap, tape, cable ties and string or rope.

- Textured surface for firm grip, even in wet environments.
- Optional hook blade for cutting cardboard and tape. Only blunt edges are exposed.
- Nose does not bend and expose blade, even with heavy-duty use.



ITEM NO.	PRODUCT	EACH
E628 06001	Fish Safety Knife	\$8.95

Lizard Mini-Cut Utility Knife

Permanently printed with a unique seven digit serial number making it ideal where tool traceability is required.

- Blade made from high-strength, chip-resistant stainless steel.
- Designed to be discarded when the blade dulls.
- High-impact body with high visibility color. • Minimal cutting depth.
- Made using FDA compliant, food safe colors.
- Sanitizer and dishwasher safe.



▶ SOLD PER BOX OF 6 KNIVES.

ITEM NO.	PRODUCT	BOX
1156 00025	Lizard Mini-Cut Utility Knife	\$17.16

Disposable Concealed Blade Safety Knife

Easier to pull. Safer to cut.



- Concealed blade reduces the chance of injuries.
- Nose can act as splitter for puncturing and opening packing tape.
- Flow-through cutting channels cut up to 4/25-inch materials.
- Large tethering loop helps avoid loss.
- Stainless steel blade for a long blade life.



ITEM NO.	PRODUCT	MFR. NO.	EACH
3078 00581	Concealed Blade Safety Knife	SK-15	\$3.95

Metal Detectable Klever Cutter

Designed to be used safely within food service manufacturing facilities utilizing a metal detection process.

- Made from metal detectable plastic with a stainless steel blade.
- Dual hook design lasts twice as long as single blade box cutters.
- Food contact allowed. • 1-1/4" x 4-5/8.

Unique cardboard piercing shape.

Recessed blade prevents injuries and inventory damage.



ITEM NO.	PRODUCT	EACH
E273 00071	Klever Cutter	\$5.70

Lizard Safety Knife



Eliminates all loose and broken razor blades — and the injuries associated with them.

- Constructed of high-impact, shatter-resistant plastic and specially formulated surgical stainless steel resists corroding.
- Will bend, not shatter under normal use.
- Can be used with either hand.



Safety blade guard automatically retracts after use.



▶ SOLD PER BOX OF 6 KNIVES.

ITEM NO.	PRODUCT	BOX
1156 00365	Safety Knife	\$23.81

EdgeMaster™

The Best Quality Steel Bandsaw Blades You'll Ever Use



► SEE PAGES 400-402

BLADES

FIND IT FAST

Bone Collector System	398
Grinder Plates and Knives	398-399
Bandsaw Blades	400-402
Hyde Processing Blades	402
Tray Pack Blades	403
Circular Blades	404-405
Specialty Blades	406-409
Scalpel Knives	410
Replacement Specialty Blades	410-411

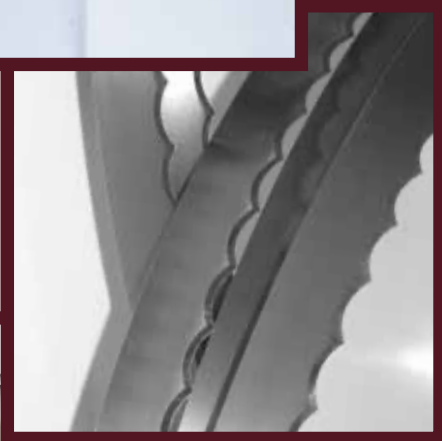

FOUR STEPS TO THE RIGHT SPECO™ GRINDER PLATE



1. Determine the plate size of your grinder.

Measure the diameter of the grinder plate and match it up to the corresponding plate size below:

DIAMETER	2-3/4"	3-1/4"	3-15/16"
PLATE SIZE	#12	#22	#32
DIAMETER	5-1/8"	6"	8-5/8"
PLATE SIZE	#52	#56	#66

2. Identify grinder plate mounting style.

Look at your grinder plate and match up the face shape to one of the styles listed below:



Universal Style
(Also works for
Cleveland Style.)



Cleveland Style

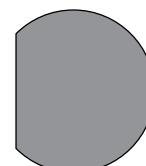

Toledo Style

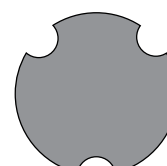

Enterprise Style

3. Determine hole size.

The hole sizes we are referring to are the holes that are cut into the top side of the grinder plate. Choose from the following sizes:

HOLE SIZE	1/8"	3/16"	1/4"	3/8"
HOLE SIZE	1/2"	3/4"	1"	

4. Hub or hubless plate?

Plates with a center hub are stronger and easier to remove from grinder. Hubless plates are reversible for extended wear.

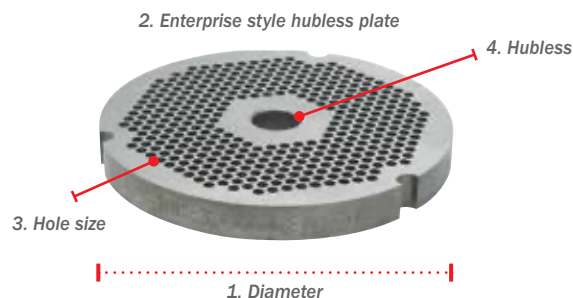
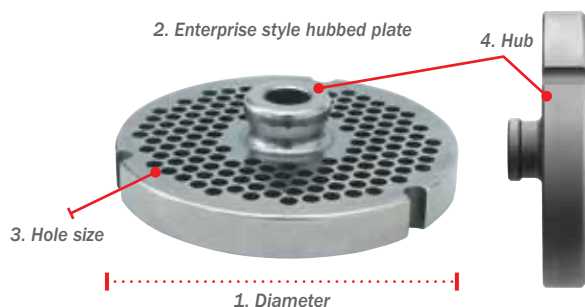

Bone Collector System

Solid hub bone collector plates in the following sizes:

- Hole sizes: 3/32 inch, 1/8 inch, 5/32 inch and 3/16 inch.
- Plate diameters: 5-1/8 inch, 6 inch, 8-5/8 inch and 11 inch.
- Grinder sizes: 52, 56, 66 or 11.

NOTE: When ordering please specify the following: machine make and model, plate hole and size and plate mounting style.

SPECIAL
ORDER
ITEM



Scan to watch
a video about
the Speco Bone
Collector System

SHOP 24/7
bunzlpd.com



Need Help?
Chat With Us
Online!



Speco™ Knives

Solid Drop Forged Knives

Constructed out of one solid piece of heavy-duty forged steel.

- Excellent for low-volume rugged meat processing jobs.
- Not recommended for sharpening.
- Most economical knife available.



ITEM NO.	PLATE SIZE	EACH
1044 00121	#12.....	\$27.95

"XL" Knives

Constructed out of one solid piece of INOX stainless steel.

- Raised edge allows blades to be resharpened and last longer than solid-forged knives.



ITEM NO.	PLATE SIZE	EACH
3046 35481	#22.....	\$31.71
3046 16011	#32.....	22.86

Everlasting Knives

- Outwears regular drop-forged or snap-in knives.
- High wear-resistant cutting edge fused solidly to a drop-forged frame.

NOTE: These knives can be resharpened.

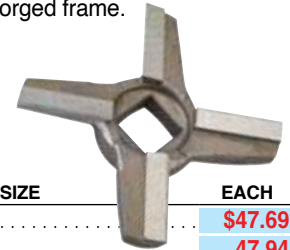

ITEM NO.	PLATE SIZE	EACH
3046 7159	#12.....	\$47.69
3046 7320	#22.....	47.94
3046 0900	#32.....	56.26
3046 6506	#52.....	70.00
3046 4660	#56.....	70.00
3046 6940	#66.....	174.19

Reversible Grinder Plate with FREE Knife

- Computer-drilled holes for precision alignment and total coverage across the plate.
- Maximum number of holes per plate permits higher production volume and cooler cutting.
- Reversible plates are super sharp and can be re-sharpened.
- One FREE drop-forged knife comes with each plate.

NOTE: Hub style plates available. CALL FOR DETAILS.

ITEM NO.	PLATE SIZE	HOLE SIZE	EACH
1044 1012	#12.....	3/16"	\$85.22
1044 0861	#12.....	1/8"	74.23
1044 1022	#22.....	3/16"	76.18
1044 0863	#22.....	1/8"	91.15
1044 1032	#32.....	3/16"	120.47
1044 0865	#32.....	1/8"	106.50



Order grinder plate, get knife FREE!

Double Life- Stainless Steel Grinder Plate with a Reversible Hub

Stainless steel plate won't rust!

- Grinder plate comes in Enterprise style with Everlasting knives.
- #32 plate with 9/64 inch hole size (only).



Reversible hub allows both sides of grinder plate to be used, doubling the plate's life.

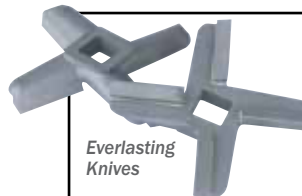
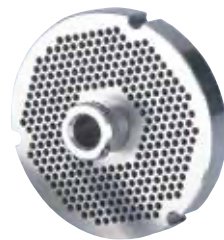

Two hard edge grinder knives FREE with each plate!

ITEM NO.	PRODUCT	EACH
3363 4675	Grinder Plate and Knives	\$150.60

Triumph Knives with Holder



The most sanitary meat grinder mincer cutting edge ever developed.

- Release and lock blade insert with a twist.
- Only the cutting edge touches the plate, reducing friction and temperature rise.
- Easy to clean and keep clean.

NOTE: Replacement blades available. SEE BELOW.

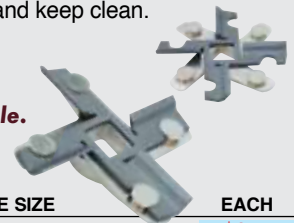

ITEM NO.	PLATE SIZE	EACH
3046 3184	#52.....	\$64.05
3046 3426	#56.....	64.72
3046 3187	#66.....	107.81

Triumph Blade Insert Replacement Knives

NOTE: Blade only. Holder NOT INCLUDED.



ITEM NO.	PLATE SIZE	EACH
3046 50211	#32.....	\$10.50
3046 31941	#52.....	11.85
3046 31951	#56.....	11.85
3046 70371	#66.....	14.05

EdgeMaster™ Performer America's Finest Quality Bandsaw Blades

High yield, 3- or 4-tooth design gives smooth cuts, less waste.

- Made of super-hard steel with precision-stamped, specially tempered tooth set for smooth sharp cutting and long-lasting performance.
- Accurate, narrow blade tooth set permits faster, cleaner cuts. • Meat waste, bone dust, and vibration are reduced and scoring is eliminated.
- All welds are guaranteed for the life of the band.



▶ 6 PER BAG - 4 BAGS PER CASE.

ITEM NO.	MACHINE	LENGTH	BLADE SPEC.	BAG
3363 07115	Biro 1433	108"	5/8" x 0.025" x 3T	\$75.24
3363 06015	Biro 33	116"	5/8" x 0.025" x 3T	75.24
3363 06035	Biro 3334	124"	5/8" x 0.025" x 3T	76.77
3363 92705	Biro 3334	124"	5/8" x 0.025" x 4T	76.77
3363 06045	Biro 44	135"	5/8" x 0.025" x 3T	76.77
3363 06055	Butcher Boy B-12	98"	5/8" x 0.022" x 4T	\$63.40
3363 06065	Butcher Boy B-14	112"	5/8" x 0.025" x 3T	75.24
3363 06075	Butcher Boy B-16	126"	5/8" x 0.025" x 3T	76.77
3363 01265	Butcher Boy B-16	126"	5/8" x 0.025" x 4T	76.77
3363 06085	Butcher Boy SA-20	154"	5/8" x 0.025" x 3T	78.52
3363 06055	Hobart 5212	98"	5/8" x 0.022" x 4T	\$63.40
3363 06065	Hobart 5214, 5614	112"	5/8" x 0.025" x 3T	75.24
3363 06125	Hobart 5216	128"	5/8" x 0.025" x 3T	76.77
3363 06135	Hobart 5700, 5801	142"	5/8" x 0.025" x 4T	84.02
3363 29125	Scott/Blade Stop	129.5"	5/8" x 0.022 x 3T	\$35.90
3363 00225	Scott/Blade Stop	129.5"	5/8" x 0.022 x 4T	35.90



Accurate, narrow blade set permits faster, cleaner cuts. Impulse hardened tooth edge extends band life.



Ziploc® poly bags keeps blades dry.

▶ 6 PER BAG - 4 BAGS PER CASE.

ITEM NO.	MACHINE	LENGTH	BLADE SPEC.	EACH
3363 00765	Guardian	136"	5/8" x 0.022 x 4T	\$10.97
3363 00391	Guardian	152.5"	5/8" x 0.022 x 3T	13.01

NOTE: Most EdgeMaster™ PERFORMER Band Saw blades are packaged 6 blades per bag. 4-bags per box. Minimum order: 1 bag.

EdgeMaster™ 2000 Bandsaw Blades



▶ 6 PER BAG - 4 BAGS PER CASE.

ITEM NO.	MACHINE	LENGTH	BLADE SPEC.	BAG
3363 44285	Biro 33	116"	5/8" x 0.025"	\$75.24
3363 44305	Biro 3334	124"	5/8" x 0.025"	76.77
3363 44335	Biro 44	135"	5/8" x 0.025"	76.77



Top view.

▶ 6 PER BAG - 4 BAGS PER CASE.

ITEM NO.	MACHINE	LENGTH	BLADE SPEC.	BAG
3363 44245	Butcher Boy B-12	98"	5/8" x 0.022"	\$63.40
3363 44275	Butcher Boy B-14	112"	5/8" x 0.025"	75.24
3363 44315	Butcher Boy B-16	126"	5/8" x 0.025"	76.84
3363 44345	Butcher Boy SA-20	154"	5/8" x 0.025"	78.52

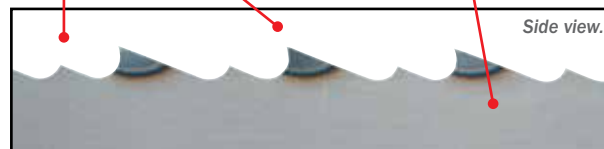

Side view.

▶ 6 PER BAG - 4 BAGS PER CASE.

ITEM NO.	MACHINE	LENGTH	BLADE SPEC.	BAG
3363 44245	Hobart 5212	98"	5/8" x 0.022"	\$63.40
3363 44275	Hobart 5214, 5614	112"	5/8" x 0.025"	75.24
3363 44265	Hobart 5700, 5801	142"	5/8" x 0.025"	78.52

1. Special design and construction permits a unique gullet tooth that removes waste and dust during cutting.
2. Enables the following tooth to cut uninterrupted and to ultimate capacity.
3. Steel composition offers wear resistance properties not available in competitive blades providing a longer life.

EdgeMaster™ Munkfors Premium Quality Bandsaw Blades



BANDSAW BLADES

Quality:

- Committed personnel with long experience in inspecting and evaluating blade design, materials, construction, and function.
- Only the best strip steel – meets or exceeds requirements for high strength, exceptional flatness, and straightness, excellent weldability and tight tolerance levels.
- Stringent standards of production and quality control guided by ISO 14001. MUNKFORS leads the development of bandsaw blades in the meat, poultry, and fish processing industries.
- Unique manufacturing technology guarantees blades of the highest quality and longevity of performance.
- Quality EDGEMASTER™ MUNKFORS blades enable our customers to improve productivity and sharpen their competitive edge.
- Small part for big value – Bandsaw blades account for a small part of production costs, but are critical in maximizing the operating performance and product yield.
- Blades exceed standard running time – maximizing profit. • Ultra-sharp teeth of uniform geometry.
- Allows use of harder steel than in conventional manufacturing methods, which increase blade reliability and stability.

Advantages:

- Swedish steel. • Longer blade lifetime. • Sharper blades.
- Less waste. • Cleaner cutting. • Minimum downtime.



All blades are individually wrapped and coiled.

▶ SOLD IN 5-PACK BUNDLES ONLY.

ITEM NO.	SIZE	TOOTH TYPE	5-PACK
C785 29195	72" x 5/8" x .022" x 3TPI	6° Hook Angle	\$51.05
C785 29345	72" x 5/8" x .022" x 4TPI	3° Hook Angle	43.00
C785 29355	80" x 5/8" x .022" x 4TPI	3° Hook Angle	45.11
C785 29435	82-3/4" x 5/8" x .024" x 4TPI	6° Hook Angle	52.11
C785 29365	91" x 5/8" x .022" x 4TPI	3° Hook Angle	47.33
C785 29555	95" x 5/8" x .024" x 4TPI	3° Hook Angle	49.44
C785 32265	97" x 5/8" x .022" x 4TPI	3° Hook Angle	47.11
C785 28495	105-3/4" x 5/8" x .022" x 3TPI	1° Hook Angle	50.67
C785 29165	108" x 5/8" x .022" x 3TPI	6° Hook Angle	51.22
C785 30365	108" x 5/8" x .024" x 3TPI	6° Hook Angle	55.42
C785 29295	112" x 5/8" x .022" x 4TPI	3° Hook Angle	52.11
C785 29065	124" x 5/8" x .016" x 3TPI	1° Hook Angle	54.44
C785 29055	124" x 5/8" x .016" x 4TPI	3° Hook Angle	62.24
C785 29135	124" x 5/8" x .020" x 3TPI	Scalloped	91.71
C785 29095	124" x 5/8" x .020" x 4TPI	3° Hook Angle	54.44
C785 29255	124" x 5/8" x .022" x 3-4TPI	6° Hook Angle	54.78
C785 29175	124" x 5/8" x .022" x 3TPI	6° Hook Angle	54.78
C785 31145	124" x 5/8" x .022" x 3TPI	1° Hook Angle	54.78
C785 29305	124" x 5/8" x .022" x 4TPI	3° Hook Angle	54.78
C785 29525	124" x 5/8" x .024" x 3TPI	6° Hook Angle	56.11
C785 29565	124" x 5/8" x .024" x 4TPI	3° Hook Angle	56.11
C785 29145	126" x 5/8" x .020" x 3TPI	Scalloped	92.89
C785 29315	126" x 5/8" x .022" x 4TPI	3° Hook Angle	55.22
C785 29485	126" x 5/8" x .024" x 3TPI	6° Hook Angle	56.67
C785 34035	127" x 5/8" x .024" x 3TPI	6° Hook Angle	62.11
C785 29125	128" x 5/8" x .020" x 4TPI	3° Hook Angle	55.22

▶ SOLD IN 4-PACK BUNDLES ONLY.

ITEM NO.	SIZE	TOOTH TYPE	4-PACK
E542 14445	129.5" x 5/8" x 0.022" x 3TPI	3° Hook Angle	38.88
E542 14455	129.5" x 5/8" x 0.022" x 4TPI	3° Hook Angle	40.96

▶ SOLD IN 5-PACK BUNDLES ONLY.

ITEM NO.	SIZE	TOOTH TYPE	5-PACK
C785 29595	131" x 3/4" x .022" x 3TPI	6° Hook Angle	\$57.67
C785 29495	135" x 5/8" x .024" x 3TPI	6° Hook Angle	58.78
C785 31935	142" x 1" x .024" x 3TPI	1° Hook Angle	93.42
C785 29155	142" x 5/8" x .020" x 3TPI	Scalloped	100.89
C785 29325	142" x 5/8" x .022" x 4TPI	3° Hook Angle	69.47
C785 30355	142" x 5/8" x .024" x 3TPI	6° Hook Angle	60.22
C785 29545	142" x 5/8" x .024" x 4TPI	3° Hook Angle	60.22
C785 00095	152.5" x 5/8" x 0.024" x 3TPI	3° Hook Angle	56.55
C785 29185	154" x 5/8" x .022" x 3TPI	6° Hook Angle	61.44
C785 29335	154" x 5/8" x .022" x 4TPI	3° Hook Angle	61.44
C785 29505	154" x 5/8" x .024" x 3TPI	6° Hook Angle	63.11
C785 30765	164-1/2" x 3/4" x .022" x 3TPI	6° Hook Angle	67.89
C785 29515	164-1/2" x 5/8" x .024" x 3TPI	6° Hook Angle	65.56
C785 29605	173" x 3/4" x .022" x 3TPI	6° Hook Angle	69.89
C785 29615	173" x 3/4" x .024" x 4TPI	3° Hook Angle	96.71
C785 13855	175-5/8" x 3/4" x .022" x 3TPI	6° Hook Angle	70.44
C785 32935	175-5/8" x 3/4" x .024" x 3TPI	1° Hook Angle	89.97
C785 29445	194-3/4" x 5/8" x .024" x 6TPI	6° Hook Angle	80.13

▶ SOLD IN 3-PACK BUNDLES ONLY.

ITEM NO.	SIZE	TOOTH TYPE	5-PACK
C785 30745	199" x 1" x .032" x 3TPI	1° Hook Angle	\$76.40
C785 29685	216" x 1" x .032" x 3TPI	1° Hook Angle	81.47
C785 29625	228" x 1" x .032" x 3TPI	1° Hook Angle	85.07
C785 31945	228" x 3/4" x .024" x 4TPI	3° Hook Angle	70.66
C785 29695	248" x 1" x .032" x 3TPI	1° Hook Angle	91.07
C785 29715	248" x 1" x .032" x 4TPI	3° Hook Angle	85.26

Scalloped Bandsaw Blades

- Ideal for cutting fresh food products, as well as foam and rubber.
NOT made for use with hard materials such as bone or frozen food products.
- Blades feature a fully sharpened scallop, 1/2 inch long or two scallops per inch.
- Constructed from 1075 series bright polished spring steel.

► 6 BLADES PER BAG - 4 BAGS PER CASE.

ITEM NO.	PRODUCT	BAG
3363 21245	124" x 5/8" x 0.022"	\$102.99
3363 01245	124" x 5/8" x 0.025"	102.99
3363 01105	126" x 5/8" x 0.022"	102.99
3363 61265	126" x 5/8" x 0.025"	102.99
3363 11285	128" x 5/8" x 0.022"	102.99
3363 2135	135" x 5/8" x 0.025"	102.99
3363 58205	142" x 5/8" x 0.020"	111.55
3363 01085	142" x 5/8" x 0.022"	111.55

ITEM NO.	PRODUCT	EACH
6466 28511	102" x 1/2" x 0.022"	\$15.95
6466 00081	120" x 7/16" x 0.016"	22.84
6466 00391	121" x 7/16" x 0.016"	23.59
3363 80231	135" x 5/8" x 0.022"	18.14
6466 88521	138" x 1/2" x 0.020"	15.06
3363 00691	152.5" x 5/8" x 0.022"	15.52

EdgeMaster™

MADE IN
USA



NOTE: Also available in stainless steel.

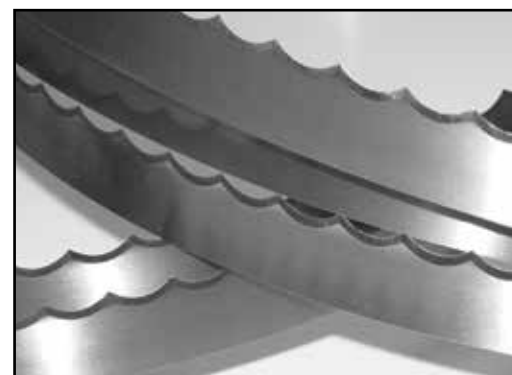

Processing Blades

Circular Blades



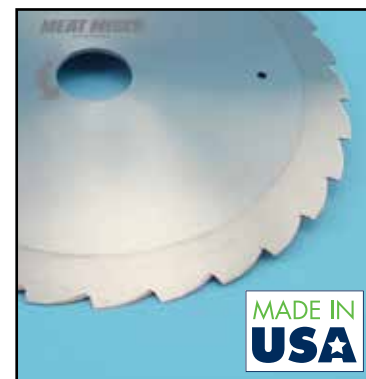

S = Single bevel; D = Double bevel

ITEM NO.	DIAMETER	BORE	THICKNESS	BEVEL	SCALLOPS	AFTERMARKET NAME AND NO.
B466 10581	8"		0.040"	D	0	Carruthers #235902/71058
B466 03221	10"	1.125"	0.094"	D	44	Hill# 4010-414
B466 03761	9"	1.25"	0.066"	D	0	Hill# 4010-110M
B466 04041	10"	1.26"	0.125"	MISER	0	Hill# 4010-429
B466 04101	12"	1.27"	0.118"	MISER	0	Hill# 4010-467
B466 19511	9.055"	1.26"	0.078"	D	0	Hill# 4010-149



Specialty Blades

Call 800-456-5624 For More Information

ITEM NO.	DESCRIPTION	LENGTH	WIDTH	THICKNESS	CUTTING EDGE	REPLACEMENT FOR OEM	AFTERMARKET NAME AND NO.	
B466 82101	Cut-Up Knife	5"	1.574"	0.118"	SB	STORK®	Hill# 4010-468	
B466 80851	Leg Cutter Blade	5.48"	1.81"	0.060"	DB	DAPEC	Hill# 4010-306	
B466 80871	Scraper Blade	10.45"	1.67"	0.090"	SB	Contherm	Hill# 401093	
F186 00071	Butterfly Knife SS	6.5"	0.5"	0.0625"	DB	Grasselli/B14802	---	---
E541 09991	Carcass Splitter Blade	24"	1.22"	0.158"	DB	Simonex	---	---
F186 00611	Wishbone Removal Tool	147 mm	74 mm	4 mm	DB	Marel	4104941	

*All parts are manufactured for Bunzl Processor Division and are not made, licensed, sponsored or approved by the original equipment manufacturer. All products listed are replacement parts only; they are not an original equipment part of the manufacturers listed and Bunzl Processor Division is not affiliated with the manufacturers listed. All references to original manufacturer's equipment are for identification purposes only. All Bunzl parts are manufactured to exacting specifications using the highest quality materials.

Tray Pack Blades for All Tray Pack Machines

Short lead times and high quality products at affordable prices.

- Single- and multi-lane tray pack blades are manufactured to the highest industry standards.
- Razor sharp tooth profile ensures quality cuts in even the most demanding of food packaging applications.
- Customize to suit unique shape and form requirements.

SPECIAL
ORDER
ITEM

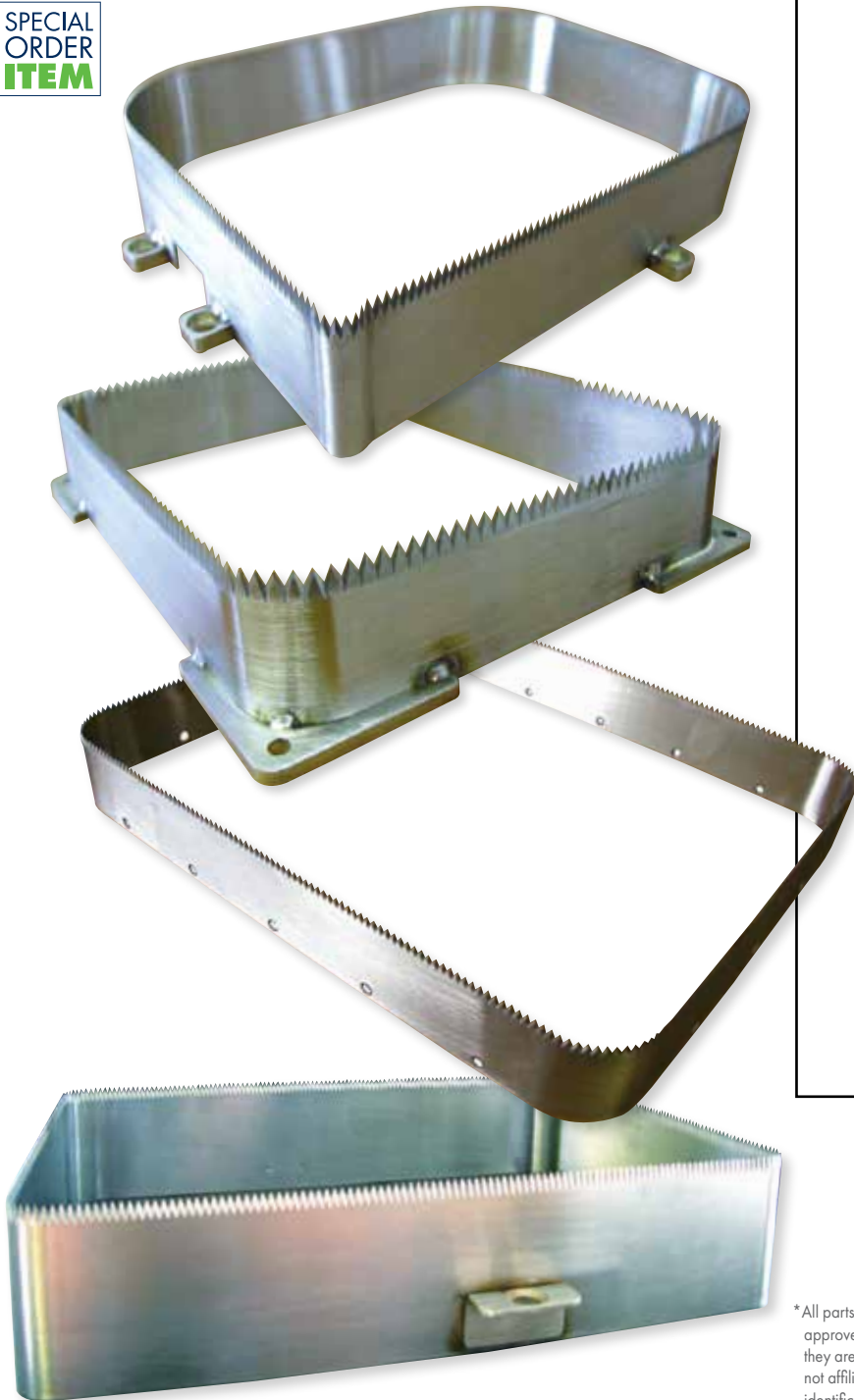

**REPLACEMENT* FOR ALL OF THE MAJOR OEM'S
IN THE MODIFIED ATMOSPHERE
PACKAGING MACHINE SECTOR, SUCH AS:**



AND MANY MORE!

**Call 800-456-5624
For More Information**

*All parts are manufactured for BUNZL Processor Division and are not made, licensed, sponsored or approved by the original equipment manufacturer. All products listed are replacement parts only; they are not an original equipment part of the manufacturers listed and BUNZL Processor Division is not affiliated with the manufacturers listed. All references to original manufacturer's equipment are for identification purposes only. All BUNZL parts are manufactured to exacting specifications using the highest quality materials.

REPLACEMENT TRAY PACK BLADES

Circular Blades



ITEM NO.	DIAMETER	BORE	THICKNESS	SLOTS	BEVEL	SCALLOPS	REPLACEMENT FOR OEM*	OEM*	AFTERMARKET NAME /NO.
L288 00051	115 mm	25 mm	1 mm		SB	Serr	ALKAR	22430	
F176 01681	350 mm	22 mm	4 mm		DB		BAADER®	94.01.0168	
E542 14001	11"	1-1/8"	0.093"	8	DB		CANTRELL		HILL# 401074S
E542 14191	11"	1-1/8"	0.071"		DB		CANTRELL	210396	HILL# 401036/M&M# 2109
E542 14121	175 mm	32 mm	2 mm	6	SB		CANTRELL/MEYN	9924904/0990.IDCO.007.00	HILL# 4010-117
E542 13851	7-1/4"	7/8"	0.08"	16	DB		CANTRELL/SIMMONS	911239/02007-01B	HILL# 4010115/M&M# 2117
B466 10581	8"	1.757"	0.04"		DB		CARRUTHERS	002359-02	
B466 00151	12"	2.109"	0.041"		DB		CARRUTHERS	002359-00	
B466 00141	14"	2.109"	0.041"		DB		CARRUTHERS	002358-00	
E542 13981	100 mm	22.2 mm	2 mm		SB		DAPEC/MEYN	02.04.000.000	HILL# 4010-474
E542 14101	125 mm	22.2 mm	1.5 mm	8	SB		DAPEC/MEYN	08.24.000.001	HILL# 4010113
E542 14111	5"	7/8"	0.059"		SB		DAPEC/MEYN	08.24.000.000	HILL# 401079
F176 21201	5"	7/8"	0.059"	6	SB		DAPEC/MEYN	02.04.000.030	HILL# 401079S
E542 14031	150 mm	22.2 mm	1.5 mm		DB		DAPEC/MEYN	02.04.000.004/FB80012	HILL# 4010-154
E542 14041	178 mm, Scalloped	22.2 mm	1.5 mm		S	44	DAPEC/MEYN	02.04.000.025	
F176 21231	7"	7/8"	0.062"	6	DB		DAPEC/MEYN	XB30050/02.04.000.027	HILL# 401015
E542 13881	7"	7/8"	0.062"		DB		DAPEC/MEYN	08.02.000.001	HILL# 401098
E542 13831	200 mm	32 mm	2 mm		DB		DAPEC/MEYN	08.24.000.002	MEYN# 0990.IDCO.001.00
E542 13891	270 mm, +Tip	40 mm	3 mm		DB		DAPEC/MEYN	08.24.000.003	401081
F176 21431	110 mm	32 mm	2 mm		SB		DAPEC/MEYN	0990.IDCO.053.00	
E542 13871	170 mm	32 mm	2 mm		DB		DAPEC/MEYN	0990.IDCO.003.00	
E542 14211	6-15/16"	7/8"	0.080"		DB		DAPEC/MEYN	0990.IDCO.050.00	
E542 14141	175 mm	32 mm	2 mm		SB		DAPEC/MEYN	0990.IDCO.002.00	HILL# 4010-140
E542 14151	175 mm, Scalloped	32 mm	2 mm		S	32	DAPEC/MEYN	SPECIAL MAKE	
E542 14051	250 mm	32 mm	2.5 mm		SB		DAPEC/MEYN	0990.IDCO.006.00	HILL# 4010-142
E542 13861	250 mm, 1 Pin Hole	32 mm	3 mm		DB		DAPEC/MEYN	0990.IDCO.047.00	
F176 21301	250 mm	32 mm	3 mm	6	DB		DAPEC/MEYN	SPECIAL MAKE	
E542 14181	270 mm, Serrated	40 mm	3 mm		DB	44	DAPEC/MEYN	02.04.000.0014	4010198
E542 13971	310 mm, Halver Blade	40 mm	3 mm		DB		DAPEC/MEYN	02.04.000.035	
E075 10641	2-1/2" Squared-Edged Pinch Blade	1-3/8"	1/8"		Flat Edge	2 Notches	DOUGHBOY		
F176 21551	4-1/2"	1"	0.093"		SB		FOODCRAFT	66020198	HILL# 401078
E542 14021	14-1/2", Keel	1-1/8"	0.095"		DB		FOODCRAFT	66015795	HILL# 401022
F176 21211	6-1/4"	1"	0.090"	4	DB		FOODCRAFT		HILL# 401021S/M&M# 2113S
B466 00381	125mm	22.2 mm	2 mm		SB	Micro	FOOD MATE	IF.05.000.060	
B466 70381	270mm	40 mm	3 mm		SB	66	FOOD MATE	IF.05.000.063	4010245
5223 00241	24"	2"	7/32"		SB	Multi	G E LEBLANC	4100003711	
B466 00401	6.25"	1"	0.090"		DB		HILL	401021	401021
E542 14011	12" Scalloped Serrated	1-1/8"	0.093"		S, DB	50	JOHNSON	41822400	HILL# 4010-249
E542 13911	12"	1-1/8"	0.093"		DB		JOHNSON	41822500	HILL# 401043
F176 21251	9"	1-1/8"	0.071"		DB		JOHNSON		HILL# 401053/M&M#2124
B466 00271	13"	1.396"	0.061"			280 ^H	KENTMASTER	4000470	
E542 13991	10"	1-1/8"	1/8"	8	DB		LEWIS	LH8410/LE90-010	HILL# 401062S/M&M# 2102S
E542 14171	10"	1-1/8"	1/8"		DB		LEWIS	LH8412/LE90-012	HILL# 401062/LH8412



ITEM NO.	DIAMETER	BORE	THICKNESS	SLOTS	BEVEL	SCALLOPS	REPLACEMENT FOR OEM*	OEM*	AFTERMARKET NAME /NO.
B466 00211	124 mm	14 mm	3 mm		SB		MAREL®	7512492	
B466 00221	120 mm	14 mm	3 mm		SB		MAREL®	7591128	
F187 46001	250 mm, Micro Serrated	32 mm	3 mm		S, SB	Micro Serr	MEYN MAESTRO	0990.ICCO.056.00	HILL# 4010-462
F187 12391	100 mm, Packaging Blade Tin Coded	30 mm	2 mm		DB		OSSID®		CP015
F187 59111	100 mm, Packaging Blade	30 mm	2 mm		DB		OSSID®	42-2591-1	
F176 21421	2-3/8" Square-Edged Packaging Blade	1"	0.104"		Flat Edge		PACKRITE	82048500A	
B466 00161	18"	1"	0.188"		SB	Multi	ROSS	3448772	
E542 14231	7-1/4"	7/8"	0.080"		DB		SIMMONS	02007-02B	
E542 13901	9"	5/8"	0.080"		DB		SIMMONS/CANTRELL	02009-05/N027005	HILL# 401017 & 401034/ SUB# CBC52122
E542 14161	9"	5/8"	0.063"	8	DB		SIMMONS		HILL# 401017S
E541 35601	12"	1 1/2"	0.125"		DB		SIMONEX		
F186 00301	125 mm	25/30 mm	2 mm		SB	Micro	STORK®	3960622	
F186 00361	150 mm	25/30 mm	2 mm		SB	Micro	STORK®	3994454	
F186 00311	100 mm	25/30 mm	2 mm		SB		STORK®	3976398	
E542 13951	110 mm	25/30	2 mm		SB		STORK®	555710	
E542 13921	165 mm	25/30 ob	2 mm	4	SB		STORK®	518391 G	HILL# 401016
B466 00101	175 mm	25/30 ob	2 mm	4	DB		STORK®	507971	
B466 00251	175 mm, Micro Serrated	25/30 ob	2 mm		S	Micro Serr	STORK®	3943357	HILL# 401073
F176 21151	200 mm	25/30 ob	2 mm	4	SB		STORK®	683074	HILL# 4010-217
E542 14201	200 mm	25/30 ob	3 mm	4	SB		STORK®	SPECIAL MAKE	
E542 14221	250 mm	25/30 ob	2 mm	4w	SB		STORK®	518180	HILL# 4010-224
F176 21011	250 mm	25/30 ob	2 mm		SB		STORK®	504237	HILL# 4010-179
E542 14061	250 mm	25/30 ob	2 mm	4n	SB		STORK®	596746	HILL# 4010-179S
B466 00291	250 mm, Micro Serrated	25/30 ob	2 mm		S	Micro Serr	STORK®	3930325	
F176 21181	250 mm	25/30 ob	2 mm	12	DB		STORK®	255502	
E542 14071	300 mm, Serrated	25/30 ob	3 mm		S	Yes	STORK®	673314/671371	
E542 14091	350 mm	25/30 ob	3 mm		DB		STORK®	669290	
F186 00101	175 mm	25/30	2 mm		SB	Yes	STORK®/MAREL®	3930331	
F186 00151	300 mm	25/30	3 mm		DB		STORK®/MAREL®	671371	
F191 18221	16.53" (Dished) Slicer	1-1/4"	3/4"		DB	0	TOBY	SK-T950182D2	









Call 800-456-5624 For More Information and Pricing

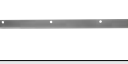

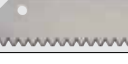





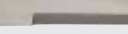















*All parts are manufactured for BUNZL Processor Division and are not made, licensed, sponsored or approved by the original equipment manufacturer. All products listed are replacement parts only; they are not an original equipment part of the manufacturers listed and BUNZL Processor Division is not affiliated with the manufacturers listed. All references to original manufacturer's equipment are for identification purposes only. All BUNZL parts are manufactured to exacting specifications using the highest quality materials.

Specialty Blades

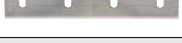
• Single bevel (SB) • Double bevel (DB)



ITEM #	PRODUCT	DESCRIPTION	REPLACEMENT FOR OEM*	OEM NO.*	LENGTH	WIDTH	THICKNESS	CUTTING EDGE	MOUNT HOLES	AFTERMARKET NAME AND NO.
F187 24011		Tape Blade	3M™	78-8017-9173-8	2.56"	1.1"	1.5 mm	Serrated	3 Slots	
F187 25071		Specialty Blade	BAADER®	940.31.45.011	4"	2-5/8"	5 mm	SB	2 Slots	
F176 23461		Vent Drill Eviscerator	BAADER® LINCO®	292346 19285661	61 mm	29½ OD	25 ID	SB	Slot Locks	
F176 21321		Hock Cutter Blade	BARKER		29"	1/2"	1/8"	DB	4	HILL# 401002NS M&M# 2101
F176 21641		Hock Cutter Blade w/ Notches	BARKER		29"	1/2"	1/8"	Notched	4	HILL# 401002
F176 78101		Spiral Slicer	CARRUTHERS	000178-10	21-5/8"		0.062"	SB	Yes	
F176 01051		Spiral Slicer w/ 4 Mounting Holes	CARRUTHERS		21-5/8"		0.100/ 0.110"	SB	Yes	
F187 22091		Piercing Blade	CRYOVAC®	FUR-58463	45.6 mm	10.3 mm	0.80 mm	45° w/pt	1	
F186 00011		Narrow Cut Blade	CRYOVAC®	PE20S074	345 mm	15 mm	1.2 mm	SB	0	PE20S04SB
F187 22111		Packaging Cutoff Blade	CRYOVAC®	2070A-8550	385 mm	19 mm	1.3 mm	Serrated	Yes	
F187 22131		0.080" Standard Packaging Cutoff Blade	CRYOVAC®	PV01S004 FUR82607	414 mm	46.25 mm	0.080" STD	Serrated	2	
F187 22121		0.125" Heavy Duty Packaging Cutoff Blade	CRYOVAC®	PV01S004 THICK VERSION	414 mm	46.25 mm	1.25 HD	Serrated	Yes	
F187 22151		Packaging Cutoff Blade	CRYOVAC®	PV01S005 FUR82606	514 mm	35 mm	0.50 mm	Serrated	Yes	
F187 15351		Packaging Cutoff Blade	CRYOVAC®	PV23S001	570.2 mm	50.5 mm	0.80 mm	Serrated	2	
F264 05261		Packaging Shear Blade	CRYOVAC®	PV2S002	526 mm	50 mm	1 mm	Serrated	Yes	
L228 00031		2-Tooth Piercing Blade	CRYOVAC®	4-35166	41 mm	45 mm	1 mm	2 Tooth SB	2	
F186 21351		Leg Processor Blade	DAPEC		138.8 mm	35 mm	1.6 mm	DB	1 Hole 2 Slots	
F187 44401		Leg Processor Blade, Large HD Thick Version	DAPEC		193.8 mm		1.6 mm	DB	2 Slots	HILL #4010-338
F176 21311		Wing Blade	DAPEC	FB038055	12-3/4"	1-1/2"	1/16"	DB	0	HILL #401046
F187 21881		Tape Blade	DEKKA	06-015	60 mm	24.5 mm	1.6 mm	Serrated	2 Slots	
F186 00621		Leg Skinner Blade	FOODCRAFT	66016713	3 7/16"	5/8"				401060
F186 23031		Leg Processor Knife	FOODCRAFT	6015277	3-1/2"	5/8"	1/8"	DB	No	HILL# 401009















ITEM #	PRODUCT	DESCRIPTION	REPLACEMENT FOR OEM*	OEM NO.*	LENGTH	WIDTH	THICKNESS	CUTTING EDGE	MOUNT HOLES	AFTERMARKET NAME AND NO.
F186 00591		Cylindrical Blade	FOODMATE	IF.05.002.040	34 mm			SB		
F187 00101		Leg Blade	FOODMATE	IF.05.002.031	114 mm	20 mm	1.8 mm			
F187 00151		Plow Blade	FOODMATE	IF.05.002.048	131.2 mm	27.4 mm	1.778 mm			
F186 30201		Leg Tendon Blade	FOODMATE	IF.05.002.015	191 mm	30 mm	2 mm	Straight	2 Slots	
F187 21921		Leg Processor	FOODMATE	IF.05.002.005	192 mm	25.25 mm	3.1 mm	DB	4 Slots	
F187 00021		Leg Processing Blade RH	FOODMATE	IF.05.002.029	43.39 mm	24.3 mm	2 mm	Single Bevel		
F187 00031		Leg Processing Blade LH	FOODMATE	IF.05.002.030	43.39 mm	24.3 mm	2 mm	Single Bevel		
0098 00061		Arched 1/2 Moon Blade	FOODMATE	DF.000.606.00	212 mm	80 mm	3 mm	Double Bevel	4 Slot	
F187 19451		Packaging Blade	HART		17"	1"	0.040"	Serrated		
F176 21381		Evisceration Vent Drill	JOHNSON	2421530321CCW	2.52"	1.237"	0.97"	Bore	Slot Locks	
F176 21391		Evisceration Vent Drill RH Blade CW	JOHNSON	2421530320CW	2.52"	1.237"	0.97"	Bore	Slot Locks	
0098 62525		Celanese Vent Opener SS	JOHNSON	R-016252S	1.625"	0.740"	0.036"	DB	2 Slots	HILL# 401045
F187 94401		Chub Cutoff Knife	K-PAK	007-52671-000						
K069 00111		V-Anvil Lower	K-PAK	007-52702-000						
K069 00101		V-Anvil Upper	K-PAK	007-52703-000						
E516 00401		V-Insert Cutoff	K-PAK	007-60650-040						
E516 10201		V-Punch	K-PAK	007-52701-020						
E516 01501		V-Assembly Lower Punch	K-PAK	007-53810-150						
E516 00501		V-Assembly Upper Punch	K-PAK	007-53810-050						
F187 21861		Processing Blade	LINCO®		190 mm	25 mm	1.2 mm	DB	4 Slots	
F264 26401		Tape Blade	LITTLE DAVID	PCS11B4	62 mm	25 mm	0.50 mm	Serrated	3 Holes	
E542 14461		Packaging Blade	M-TEK	113021C1	16-5/8"	1.062"	0.079"	Serrated	Yes	TARHEEL #CP-301
F186 00171		CMK04 Straight Knife, Disposable	MAREL®	091400457						
B466 87121		L-Shaped, I-Cut Blade	MAREL®	0200-999-80118201	341.91 mm	90.09 mm	1.5 mm	L-shp DB	2 Holes	NOR-80118201
7949 00011		Opener Blade	MAREL®	91400497	2.458"	0.750"	0.036"	DB	2 Slots	IDSL# TE03-018

Specialty Blades

• Single bevel (SB) • Double bevel (DB)



ITEM #	PRODUCT	DESCRIPTION	REPLACEMENT FOR OEM*	OEM NO. *	LENGTH	WIDTH	THICKNESS	CUTTING EDGE	MOUNT HOLES	AFTERMARKET NAME AND NO.
F187 96701		LH Leg Processor Blade	MAREL® STORK®	249670	115 mm	36.5 mm	2 mm		2 Slots	
F187 96711		RH Leg Processor Blade	MAREL® STORK®	649671	115 mm	36.5 mm	2 mm		2 Slots	
F186 00571		Rapid Cut Knife Right Side Blade	MEYN	0700.0010.E02.48						
F186 00581		Rapid Cut Knife Left Side Blade	MEYN	0700.0010.E03.48						
F186 00531		Rapid Cut Arrowhead Knife Blade	MEYN	0770.0010.E01.08						
F187 38671		Groin Cut Blade	MEYN	0990.IDC1.015.00	43.9 mm	36.2 mm	2.5 mm	SB	2 Holes	
F186 00281		Rapid Cut 1/2 Moon	MEYN	0700-0010-W01-93	84.56 mm	42 mm	3 mm	Micro-Serrated		
F176 21341		Half Circle Blade	MEYN	LPC-1458 77.50.008.50	239 mm	80 mm	3 mm	DB	4 Slots	
F187 13931		Leg Processor Blade	MEYN	LEP-2015	139 mm	33 mm	1 mm	DB	2 Slots	
3028 38651		Left Hand Vent Blade	MEYN	0338.0001.331.0	73 mm	32 mm ID	3 mm	SB		
3028 38641		Right Hand Vent Blade	MEYN	0338.0000.316.0	73 mm	32 mm ID	3 mm	SB		
F187 22161		Vent Opener Blade	MEYN	0774.000.000.315 200050154	104 mm	45 mm	0.05 mm	Serrated	Yes	4010-311
F186 00141		Dish Slitter Blade	MULTIVAC	79.915.2008.03	102 mm	70 mm	1 mm	SB		
F264 06611		Tin Slitter Blade, 2pcs	MULTIVAC		115 mm	25 mm	1 mm	DB	3 per	
L228 00041		2pc SS Slitter Blade DB	MULTIVAC	79.915.2009.41	90 mm	42 mm	2 mm	DB	3/Blade	
F187 09421		2pc SS Slitter Blade SB	MULTIVAC	79.915.2009.42	90 mm	42 mm	2 mm	Single	3/Blade	
F264 04051		Cutoff Blade	MULTIVAC		405 mm	40 mm	1 mm	DB Scalloped	2, No Notches	
F264 04761		260 mm Cutoff Blade	OMORI	HFM147001	260 mm	32 mm	2 mm	SB	3	
F187 22101		Packaging Blade	OSSID®	025-000-17	10-1/2"	0.393"	0.04"	Serrated	2	
F187 25961		Packaging Cutoff Blade	OSSID®	2-475-3	280 mm	45 mm	1.2 mm	Serrated	4 Slots	
F187 22061		Packaging Cutoff Blade	PACMAC	9202-0009	20-1/4"	1.05"	0.064"	Serrated	2	HILL #4010-207
F187 00641		Serrated Packaging Blade Tin Coated	PACMAC	9200-064	20-1/4"	1.05"	0.064"	Serrated	2	
F187 95211		Cutoff Blade w/Tear Notch	PACMAC	9202-00095SDB2-1	20-1/4"	1.05"	0.064"	DB	w/Tear Notch	

ITEM #	PRODUCT	DESCRIPTION	REPLACEMENT FOR OEM *	OEM NO. *	LENGTH	WIDTH	THICKNESS	CUTTING EDGE	MOUNT HOLES	AFTERMARKET NAME AND NO.
F187 00951		Packaging Cutoff Blade	PACMAC	9202-00095	20-1/4"	1.05"	0.064"	Scalloped	2	
F187 22821		Perforating Blade	PACMAC	9502-0009P	20-1/4"	1.05"	0.064"		Yes	
F176 00171		Spreader Bar	PACMAC	9212-0017	29"		1/2"			
F187 19151		Net Blade	POLY CLIP®	71678	175 mm	19 mm	2 mm	SB	No	
F187 32011		Crosscut Blade	REISER	A-352-04320.1	12"	1-3/8"	1 mm	SB	2	
F264 04951		Tapered Tin Blade	ROSS		495 mm	70/60 mm	0.8 mm		7 Slots	
F187 22071		Packaging Blade	SANDIACRE	KNI4464	335 mm	18.5 mm	2.5 mm	Serrated	2	
F187 22081		Packaging Blade	SANDIACRE		365 mm	18.5 mm	2.5 mm	Serrated	Yes	
F187 20501		Cutoff Knife	TIPPER TIE	11-0140-05		1"	1/8"	SB		
F187 33521		Packaging Blade	TRIANGLE	A83352	465 mm	25 mm	1.5 mm	Serrated		
F187 19301		Packaging Blade	TRIANGLE	A12279	13-7/8"	1"	0.062"	SB		
F187 03451		Packaging Cutoff	TRIANGLE		345 mm	26 mm	1.2 mm	SB Scalloped	2 Mtg Holes	HILL #4010-282
F264 04741		Piercing Blade	TRIANGLE		474 mm	25.4 mm	1.5 mm	Serrated		4010-340
F264 04751		Tin Cutoff Blade	TRIANGLE	A38349	474 mm	25 mm	1 mm	Serrated		
F264 04771		EZ Open Blade	ULMA	6254938	425 mm	57 mm	3.5/2.5 mm	Serrated	2	

Call 800-456-5624 For More Information and Pricing

*All parts are manufactured for BUNZL Processor Division and are not made, licensed, sponsored or approved by the original equipment manufacturer. All products listed are replacement parts only; they are not an original equipment part of the manufacturers listed and BUNZL Processor Division is not affiliated with the manufacturers listed. All references to original manufacturer's equipment are for identification purposes only. All BUNZL parts are manufactured to exacting specifications using the highest quality materials.

Replacement V-Tooth Slicer Blade

- Compatible with GROTE® Slicers.

NOTE: Other sizes available upon request.



► 50 BLADES PER PACK.

ITEM NO.	SIZE	EACH
C785 00041	172-3/8" x 1/2" x 0.020"	\$20.65
C785 00051	192-3/8" x 1/2" x 0.020"	23.75
C785 00061	124-15/16" x 1/2" x 0.020"	16.95
C785 00115	137-15/16" x 1/2" x 0.020" (5/Pack)	90.15

*GROTE® is a registered trademark of J.E. Grote Company, Inc. This product is a replacement part; it is not an original equipment part of and is not affiliated with J.E. Grote Company, Inc. All references to original equipment are for identification purposes only.

Scalpel Knives

- Easy to replace, wrapped, stainless steel blades.
- Contoured, textured handle. • Length: 2.876 inches.



ITEM NO.	PRODUCT	EACH
3363 00431	Poly Blue Scalpel Knife Handle	\$36.25
1060 80265	#60 Poultry Blades, Stainless Steel (150/Box)	174.70

Rib Pulling Handle and Blades

- Molded plastic handle. • 6-1/4 inch stainless steel arm.
- Blades are easily replaced.

ITEM NO.	PRODUCT	EACH
A657 34101	A. Rib Pulling Handle	\$67.21

NOTE: Blades and handle are sold separately.

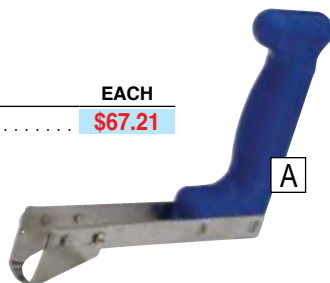

► 5 PER PACK.

ITEM NO.	PRODUCT	PACK
A657 14121	B. 12 mm Blade	\$23.90
A657 14145	14 mm Blade	23.90
A657 14165	16 mm Blade	23.90
A657 14185	18 mm Blade	23.90
A657 14205	20 mm Blade	23.90
A657 14225	22 mm Blade	23.90
A657 14255	25 mm Blade	23.90



Replacement Slicing Blades

- Compatible with GRASSELLI® Slicers.

NOTE: Other sizes available upon request.

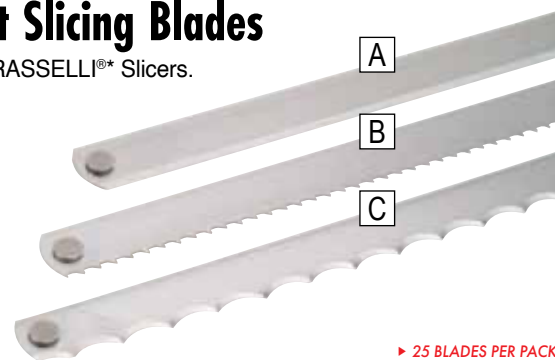

► 25 BLADES PER PACK.

ITEM NO.	PRODUCT	SIZE	PACK
E542 14405	A. Knife Edge Slicer Blade	17-5/8" x 5/8" x 0.020"	\$147.00
E542 14385	B. 6 TPI Slicer Blade	17-5/8" x 5/8" x 0.022"	147.00
E542 14415	C. Scallop Edge Slicer Blade	17-5/8" x 5/8" x 0.022"	147.00

► 50 BLADES PER PACK.

ITEM NO.	PRODUCT	SIZE	PACK
6466 6016	C. Scallop Edge Slicer Blade	17-5/8" x 7/16" x 0.016"	\$284.24

*GRASSELLI® is a registered trademark of Grasselli Company. This product is a replacement part; it is not an original equipment part of and is not affiliated with Grasselli Company. All references to original equipment are for identification purposes only.

Replacement Peeler Blades

- Compatible with TOWNSEND® Model 2600.

► 20 BLADES PER BOX.

ITEM NO.	OEM#	BOX
7949 30315	25155	\$60.48

*TOWNSEND® is a registered trademark of Marel Meat Processing, Inc. This product is a replacement part; it is not an original equipment part of and is not affiliated with Marel Meat Processing, Inc. All references to original equipment are for identification purposes only.

Replacement Peeler Blades

- Compatible with RANGER®.
- 0.012-inch x 0.324-inch stainless steel.

► 100 BLADES PER BOX.

ITEM NO.	OEM#	BOX
A657 00015	880242	\$68.40

*RANGER® is a registered trademark of Ranger Blade Mfg. This product is a replacement part; it is not an original equipment part of and is not affiliated with Ranger Blade Mfg. All references to original equipment are for identification purposes only.

Poultry Lung Scraper

- Overall length: 12-1/2 inches. • Blade: 1 inch x 1-3/4 inches.
- Stainless steel with plastic handle.



ITEM NO.	PRODUCT	EACH
2990 10561	Lung Scraper	\$99.10

Skinner Blades

Setting the standard for quality and precision.

- Engineered to provide maximum yields. • Proven edge geometry for all applications.
- Polished cutting edge eliminates product loading of cutting edge.
- Long lasting cutting edges reduce blade replacement downtime.



NOTE: Blades are individually packed in a heat sealed safety package, preserving cutting edge integrity and protecting plant personnel.

ITEM NO.	PRODUCT	OEM#	QTY/PACK	F.O.B. FACTORY CASE
5880 6354	518 mm x 22 mm x 0.7 mm.	16354.	100 Individually Packaged	\$416.95
5880 0840	670 mm x 22 mm x 0.7 mm.	9759302.	100 Individually Packaged	655.95
5880 0004	517 mm x 22 mm x 0.7 (Carbon).	100 Individually Packaged	292.95

ITEM NO.	PRODUCT	OEM#	QTY/PACK	F.O.B. FACTORY EACH*
5880 82321	518 mm x 25 mm x 0.7 mm.	18232.	100 Individually Packaged	\$5.95
5880 6952	365 mm x 22 mm x 0.7 mm.	9726952.	100 Individually Packaged	3.95
5880 00031	392 mm x 22 mm x 0.7 mm.	9727955.	100 Individually Packaged	3.95

*100 Minimum

NOTE: Available in sizes ranging from 77 mm to 1,000 mm long in either 0.7 mm or 1.0 mm thickness. CALL FOR DETAILS.

Replacement Hand Held Skinner Blades

- Compatible with BEST & DONOVAN® S-1011.



▶ 100 BLADES PER BOX.

ITEM NO.	PRODUCT	SIZE	BOX
1060 0101	Carbon Steel	3-3/4" x 7-9/10"	\$53.32
5880 3062	Skinner Blades (100/pack)	3-3/4" x 7.9"	89.95

* BEST & DONOVAN® is a registered trademark of Best & Donovan N.A. This product is a replacement part; it is not an original equipment part and is not affiliated with Best & Donovan N.A. All references to original equipment are for identification purposes only.

Spinal Cord Remover

- Constructed of stainless steel to resist rusting.
- Pork blade length: 1 inch.
- Beef blade length: 1-1/2 inches.
- Overall length: 7-1/2 inches.
- Machine washable.
- Heavy-duty plastic handle.



ITEM NO.	PRODUCT	EACH
6466 0600	Spinal Cord Remover	\$30.26
6466 0601	Beef Replacement Blade	3.45
6466 0602	Pork Replacement Blade.	3.55

Hog Hide Shaver

▶ SEE PAGE 445
For More Details and Hog Scraper Accessories



ITEM NO.	PRODUCT	EACH
0891 00021	Hog Hide Shaver Handle	\$69.95
5880 3062	Skinner Blades (100/pack)	89.95

110 mm Dehider Blades



- For use on cattle, veal, hogs and sheep.
- Skins perfectly: no cuts, marks or holes.
- Compatible with JC-III and JC-IV model dehiders.



NOTE: We sell Jarvis® Dehiders. CALL FOR DETAILS.



ITEM NO.	OEM#	PAIR
3028 0155	3023011.	\$237.63

Involute Blades

Replacement Involute blades for high speed slicers manufactured by Weber®, Formax®, Thurne® and many others.

- Various edge angles are available from 22° to 32°.
- All blades are available coated and uncoated.



We are a full-line stocking distributor for JARVIS REPLACEMENT PARTS AND BLADES FOR ALL JARVIS TOOLS.

Call 800-456-5624 For More Details

Our Commitment to Humane Stunning

Bunzl Processor Division has established itself as the premier partner for humane handling in the food processing industry. Our commitment to this cause is unparalleled in the marketplace. We offer FREE ON-SITE CONSULTATION to assist customers in determining the right humane stunning equipment needs for each environment.



Chuck Bildstein

Humane Stunning and Equipment Specialist

Chuck has been recognized as one of the top influences in Humane Animal Handling. He has worked closely with Temple Grandin, Ph.D., in the area of humane stunning. He was a part of the AMI team that traveled to Washington DC to present at a congressional briefing on animal welfare and has lectured at various universities in the U.S. and Canada. We are proud to have Chuck on the BPD/Koch Supplies Team for over 24 years.

Chuck can be contacted by dialing 319-573-6121 or by email at charles.bildstein@bunzlusa.com



Ryan Malone







MRO and Equipment Specialist







Ryan received experience in humane animal handling as assistant manager at the Kansas State University Meat Lab and graduated with a degree in animal science. He was also Meat Judging National Champion and All American at Fort Scott Community College. We are proud to have Ryan on the BPD/Koch Supplies Team for over 3 years.

Ryan can be contacted by dialing 816-820-7768 or by email at ryan.malone@bunzlusa.com

SPECIES APPLICATION KEY

Refer to this chart when choosing cartridges on pages: 414, 416, 418, 420, 422.

SYMBOL	SPECIES	WEIGHT RANGE
	Rabbits	All Sizes
	Poultry	All Species and Sizes
	Lambs	Neonate to 50 pounds
	Sheep	51 pounds +
	Goats	51 pounds +
	Piglets	Neonate to 35 pounds
	Hogs	36 to 125 pounds 126 pounds +

SYMBOL	SPECIES	WEIGHT RANGE
	Sows & Boars	300 to 400 pounds 401 pounds +
	Small Cattle	Up to 500 pounds
	Fat Cattle	501 pounds +
	Bulls	2,000 pounds +
	Bison	All Sizes
	Horses	All Sizes

PROCESSING

FIND IT FAST

Our Commitment to Humane Stunning	412
Species Application Key.	412
JARVIS® PAS Stunners and Parts	414-422
Temple Grandin Books	420
PAS Stun Tester	421
Cleaning Tools.	423
JARVIS® Pneumatic Stunners	424-425
Pneumatic Stun Tester	425
Body Protection and Rattle Paddles.	426
Cattle Prods.	427
Pneumatic Dehider, Skinner and Circular Saw	427
Packers Kromer™ INOX PRO® Balancers	429
Wellsaws and Parts.	430-433
Breaking Saws.	434
Splitting Bandsaw	435
Rail Switches	436-437
VGK Trolley System.	438
Trolleys	439
Hooks, Meat Trees, Gambrels and Shackles	440
Weasand Clips, Rings, Plugs and Pliers.	441
Processing Tags	442
Tagging Systems and Marking Supplies	443
Handsaws and Hand Tools	444
Hog Scrapers, Paddles, Whips and Supplies	445
Plumatech Picking Fingers, Supplies and Gaskets	446-447
Stamps, Inks and Tattoo Accessories.	448-449
Skinner's Rollers, Pinch Blocks, Cones and Rings.	450



Power Actuated Stunners (PAS) TYPE-P Standard Bolt



Concussion Head Assembly

- Uses a non-penetrating head to strike a powerful blow to the head of small animals for instantaneous euthanasia.
- Designed for small animals only, such as swine up to 60 pounds, turkeys of all sizes, chickens, rabbits, ducks, and geese.



ITEM NO.	PRODUCT	JARVIS NO.	EACH
3028 77201	Concussion Bolt Assembly . . .	3116606.	CALL

PAS-PS 22R

.22 Caliber, STANDARD BOLT

- Comfortable, ergonomically designed handle.
- Diverse applications, from smaller to larger sized livestock.
- Renders animal insensible to pain before slaughter.
- Simple to use, operate and maintain.
- Ruggedly built for long service life.
- Different cartridge strengths available, depending on usage.
- Includes case and cleaning tools.

PAS-PS 25S

.25 Caliber, STANDARD BOLT

ITEM NO.	PRODUCT	JARVIS NO.	EACH
3028 77041	PAS-PS-22, Standard Bolt .22 Cal.	4144150.	CALL
3028 35911	PAS-PS-25, Standard Bolt .25 Cal.	4144152.	FOR
3028 77981	PAS-P Replacement Stunner Case	3161009.	PRICING



PAS-PS 22R Suggested Cartridges: Caliber .22R

ITEM NO.	DESCRIPTION .22R	ROUNDS/PKG	CARTRIDGES	JARVIS NO.	APPLICATIONS
3028 35595	Pink Cartridge, 1.25 Grain	1,000		1176003	
3028 35635	Pink Cartridge, 1.25 Grain	50		1176004	
3028 77125	Purple Cartridge, 2.5 Grain	1,000		1176005	
3028 36045	Purple Cartridge, 2.5 Grain	50		1176006	
3028 77195	Green Cartridge, 3.0 Grain	1,000		1176007	
3028 35645	Green Cartridge, 3.0 Grain	50		1176008	

PAS-PS 25S Suggested Cartridges: Caliber .25

ITEM NO.	DESCRIPTION .25	ROUNDS/PKG	CARTRIDGES	JARVIS NO.	APPLICATIONS
3028 77225	Pink Cartridge, 1.25 Grain	1,000		1176013	
3028 77285	Pink Cartridge, 1.25 Grain	50		1176014	
3028 35765	Yellow Cartridge, 2.0 Grain	1,000		1076029	
3028 35785	Yellow Cartridge, 2.0 Grain	50		1176030	
3028 77095	Blue Cartridge, 3.0 Grain	1,000		1176017	
3028 77265	Blue Cartridge, 3.0 Grain	50		1176018	



Scan this QR code with your mobile device to watch a video about PAS-TYPE P Stunner Maintenance

CAUTION: Do not exceed cartridge strength for prescribe usage.

CONCUSSION HEAD REPLACEMENT PARTS			
ITEM NO.	JARVIS NO.	DESCRIPTION	
101C	3028 78291	1165094	Piston
102C	3028 77561	1114228	Rubber Spring
103C	3028 78791	1109214	Sleeve
104C	3028 37151	1111498	Coupling
105C	3028 36071	1104536	Red Bumper Washer
106C	3028 77461	1104539	Nosepiece Lock Washer
107C	3028 77051	1171577	Stunning Rod Bumper
108C	3028 77491	1104537	Blue Bumper Washer
109C	3028 77741	1120533	Stunning Rod

PAS-PS Replacement Parts

PAS Type-P Specs:

- Penetrating Shaft Diameter: 0.45 inches (11.4 mm).
- Bolt Extension: 4.75 inches (121 mm) with no buffers or washers.
- Control Handle: Single trigger, manual operation.
- Overall Dimensions: 11.25 inches x 1.875 inches. x 7.47 inches (286 x 48 x 191 mm).
- Weight: 6.20 pounds (2.8 kg).

JARVIS®

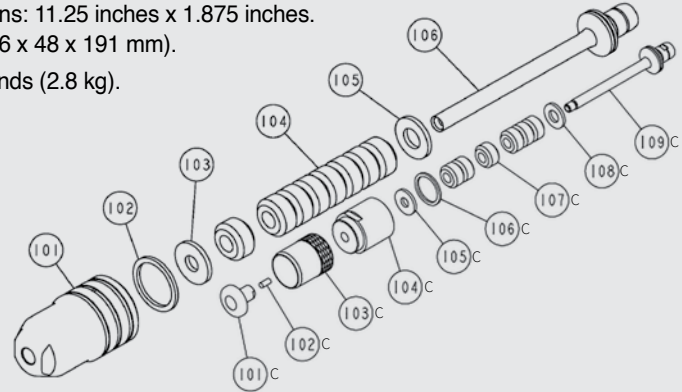

ITEM NO.	JARVIS NO.	DESCRIPTION	QTY. REQ.	
101	3028 78241	1116940	Nosepiece Housing	1
102	3028 77461	1104539	Nosepiece Lock Washer	1
103	3028 36071	1104536	Red Bumper Washer	1
104	3028 77051	1171577	Stunning Rod Bumper	8
105	3028 77491	1104537	Blue Bumper Washer	1
106	3028 77441	1120507	Stunning Rod	1

ITEM NO.	JARVIS NO.	DESCRIPTION	QTY. REQ.	
201	3028 77801	1154257	Handle Retaining Bolt	2
202	3028 78301	1110616	Firing Block Pivot Pin	1
203	3028 78261	1110618	Hammer Pivot Pin	1
204C	3028 37171	3116603	Receiver Housing .25 S	1
204B	3028 36761	3116602	Receiver Housing .25 R	1
204A	3028 37181	3116601	Receiver Housing .22 R	1
205	3028 78361	1110250	Roll Pin	1
206	3028 36771	3161001	Firing Block (w/o Dog)	1
207	3028 78161	1110617	Firing Pin	1
208	3028 78371	1136001	Firing Block Bushing	1
209	3028 36781	1118182	Hammer	1
210	3028 77601	1171582	Extractor .25	1
210A	3028 77711	1171579	Extractor .22	1
211	3028 77941	1118181	Dog	1
212	3028 78171	1145030	Dog Rivet	1
213	3028 77661	3132042	Catch Plate Assembly	1
214	3028 78281	1110620	Release Pin Dowel	1
215	3028 77671	1110619	Release Pin	1
216	3028 77511	1114253	Release Pin Spring	1
217	3028 78781	1119301	Handle	1
218	3028 77841	1102775	Handle Cover	1
219	3028 78491	1110239	Roll Pin	1
220	3028 78451	1110633	Trigger Pivot Pin	1
221	3028 77921	1118183	Trigger	1
222	3028 78441	1110621	Trigger Pin	1
223	3028 78381	1114251	Trigger Return Spring	1
224	3028 77381	1114252	Ejector Spring	1
225	3028 78551	1104001	Ribbed Lock Washer (pair)	1
226	3028 78561	1173289	Socket Head Cap Screw	1
227	3028 77951	1107493	Hex Nut	2
228	3028 78621	1154258	Trip Screw	1

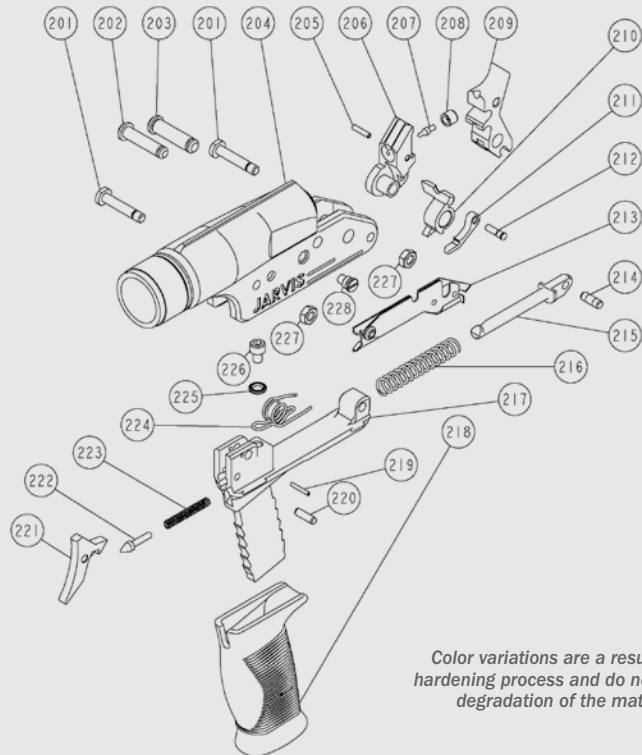

Color variations are a result of the hardening process and do not indicate degradation of the material.

ITEM NO.	JARVIS NO.	DESCRIPTION	QTY. REQ.	
214-215	3028 36501	3110009	Release Pin Assembly	1
205-208/211-212	3028 36791	3161561	Firing Block and Dog Assembly	1
205/207/208	3028 36161	3110001	Firing Pin Assembly	1

ITEM NO.	JARVIS NO.	STANDARD REPLACEMENT PARTS AVAILABLE	
216S	3028 77781	1114254	Standard Release Pin Spring
214S/215S	3028 77701	3110010	Standard Release Pin Assembly
214S	3028 78151	1110622	Standard Release Pin Dowel
209S	3028 78201	1118002	Standard Hammer

Power Actuated Stunners (PAS) TYPE-P Heavy-Duty



PAS-PHDL 25R

.25 Caliber, HEAVY-DUTY LONG BOLT

PAS-PHDS 25R

.25 Caliber, HEAVY-DUTY STANDARD BOLT

- Ruggedly built for long service life.
- Simple to use, operate, and maintain.
- Diverse applications, from smaller to larger sized livestock.
- Renders animal insensible to pain before slaughter.
- Different cartridge strengths available, depending on usage.
- Comfortable, ergonomically, designed handle.
- Includes case and cleaning tools. • Type-PHDS – Standard length bolt.
- Type-PHDL – Longer length bolt for deeper skull penetration.

Concussion Head Assembly

- Uses a non-penetrating head to strike a powerful blow to the head of small animals for instantaneous euthanasia.
- Designed for small animals only, such as swine up to 60 pounds, turkeys of all sizes, chickens, rabbits, ducks, and geese.



ITEM NO.	PRODUCT	JARVIS NO.	EACH
3028 77201	Concussion Bolt Assembly . . .	3116606.	CALL

ITEM NO.	PRODUCT	JARVIS NO.	EACH
3028 77001	PAS-PHDS 25R, Heavy-Duty Standard Bolt .25 Cal	4144155.	CALL
3028 77011	PAS-PHDL 25R, Heavy-Duty Long Bolt .25 Cal	4144132.	FOR
3028 77981	PAS-P Replacement Stunner Case	3161009.	PRICING



Carrying case and cleaning tools included.

PAS-PHDS & PHDL 25R Suggested Cartridges: Caliber .25R

ITEM NO.	DESCRIPTION .25R	ROUNDS/PKG	CARTRIDGES	JARVIS NO.	APPLICATIONS
3028 77225	Pink Cartridge, 1.25 Grain	1,000		1176013	
3028 77285	Pink Cartridge, 1.25 Grain	50		1176014	
3028 77275	Yellow Cartridge, 2.0 Grain	1,000		1176015	
3028 77735	Yellow Cartridge, 2.0 Grain	50		1176016	
3028 77095	Blue Cartridge, 3.0 Grain	1,000		1176017	
3028 77265	Blue Cartridge, 3.0 Grain	50		1176018	
3028 77085	Orange Cartridge, 3.5 Grain	1,000		1176019	
3028 77245	Orange Cartridge, 3.5 Grain	50		1176020	



Scan this QR code with your mobile device to watch a video about PAS-TYPE P Stunner Maintenance

CAUTION: Do not exceed cartridge strength for prescribe usage.

JARVIS®

MADE IN USA

PAS-PHDS and PAS-PHDL Replacement Parts

PAS Type-P Specs:

- Penetrating Shaft Diameter: 0.45 inches (11.4 mm).
- Bolt Extension: TYPE-PHDS: 4.75 inches (121 mm) with no buffers or washers.; TYPE-PHDL: 5.88 inches (149 mm) with no buffers or washers.
- Control Handle: Single trigger, manual operation.
- Overall Dimensions:
TYPE-PHDS: 11.25 inches x 1.875 inches x 7.47 inches (286 x 48 x 191 mm);
TYPE-PHDL: 11.57 inches x 1.875 inches x 7.47 inches (294 x 48 x 191 mm).

CONCUSSION HEAD REPLACEMENT PARTS			
ITEM NO.	JARVIS NO.	DESCRIPTION	
101C	3028 78291	1165094	Piston
102C	3028 77561	1114228	Rubber Spring
103C	3028 78791	1109214	Sleeve
104C	3028 37151	1111498	Coupling
105C	3028 36071	1104536	Red Bumper Washer
106C	3028 77461	1104539	Nosepiece Lock Washer
107C	3028 77051	1171577	Stunning Rod Bumper
108C	3028 77491	1104537	Blue Bumper Washer
109C	3028 77741	1120533	Stunning Rod

ITEM NO.	JARVIS NO.	DESCRIPTION	QTY. REQ.
101	3028 77911	Nosepiece Housing	1
101A	3028 77991	Nosepiece Housing – Long	1
102	3028 77461	Nosepiece Lock Washer	1
103	3028 77641	Orange Bumper Washer	1
104	3028 77051	Stunning Rod Bumper*	8
105	3028 77491	Blue Bumper Washer	1
106	3028 36001	Stunning Rod – Standard	1
106A	3028 77481	Stunning Rod – Long	1

ITEM NO.	JARVIS NO.	DESCRIPTION	QTY. REQ.
201	3028 77801	Handle Retaining Bolt	2
202	3028 78301	Firing Block Pivot Pin	1
203	3028 78261	Hammer Pivot Pin	1
204	3028 36761	Receiver Housing .25 R	1
205	3028 78361	Roll Pin	1
206	3028 36771	Firing Block (w/o Dog)	1
207	3028 78161	Firing Pin	1
208	3028 78371	Firing Block Bushing	1
209	3028 36781	Hammer	1
210	3028 77601	Extractor	1
211	3028 77941	Dog	1
212	3028 78171	Dog Rivet	1
213	3028 77661	Catch Plate Assembly	1
214	3028 78281	Release Pin Dowel	1
215	3028 77671	Release Pin	1
216	3028 77511	Release Pin Spring	1
217	3028 78781	Handle	1
218	3028 77841	Handle Cover	1
219	3028 78491	Roll Pin	1
220	3028 78451	Trigger Pivot Pin	1
221	3028 77921	Trigger	1
222	3028 78441	Trigger Pin	1
223	3028 78381	Trigger Return Spring	1
224	3028 77381	Ejector Spring	1
225	3028 78551	Ribbed Lock Washer (Pair)	1
226	3028 78561	Socket Head Cap Screw	1
227	3028 77951	Hex Nut	2
228	3028 78621	Trip Screw	1

* Long Bolt requires 9

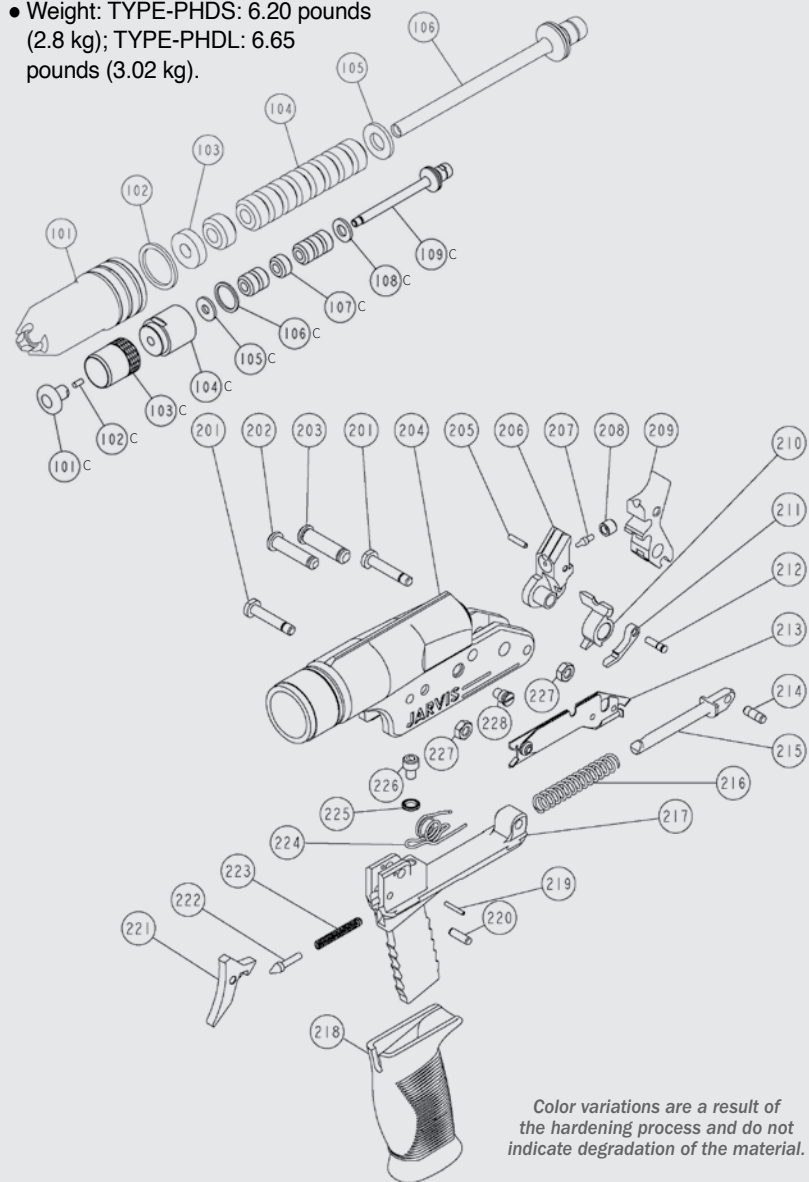

Color variations are a result of the hardening process and do not indicate degradation of the material.

ITEM NO.	JARVIS NO.	DESCRIPTION	QTY. REQ.
214-215	3028 36501	3110009 Release Pin Assembly	1
205-208/211-212	3028 36791	3161561 Firing Block and Dog Assembly	1
	3028 36821	3180008 Container and Tools Package	1

Power Actuated Stunners (PAS) TYPE-C

JARVIS®

MADE IN USA

PAS-CS 25S

STANDARD BOLT

- Penetrating Shaft Diameter: 0.45 inches (11.4 mm).
- Control Handle: Single trigger, manual operation.
- Bolt Extension:
TYPE-CS: 4.75 inches (121 mm) with no bumpers;
TYPE-CL: 5.80 inches (147 mm) with no bumpers.
- Overall Dimensions:
TYPE-CS: 14.1 inches x 2.25 inches (358 x 57 mm);
TYPE-CL: 15.09 inches x 2.25 inches (383 x 57 mm).
- Weight:
TYPE-CS: 6.50 pounds (2.9 kg);
TYPE-CL: 6.85 pounds (3.1 kg).



PAS-CL 25S
LONG BOLT

ITEM NO.	PRODUCT	JARVIS NO.	EACH
3028 77021	PAS-CS 25S, Standard Bolt .25 Cal	4144061.	CALL FOR PRICING
3028 77181	PAS-CL 25S, Long Bolt .25 Cal	4144062.	CALL FOR PRICING

PAS-CS and CL

Suggested Cartridges: Caliber .25S

ITEM NO.	DESCRIPTION .25 CALIBER	ROUNDS/PKG	CARTRIDGES	JARVIS NO.	APPLICATIONS
3028 35765	Yellow Cartridge, 2 Grain	1,000	.25S	1076029	
3028 35785	Yellow Cartridge, 2 Grain	50	.25S	1176030	
3028 35555	Black Cartridge, 4 Grain	1,000	.25S	1176034	
3028 35845	Black Cartridge HMF, 5 Grain (Lead Free)	1,000	.25S	1076036	



Scan this QR code with your mobile device to watch a video about PAS-TYPE C Stunner Maintenance

PAS-CSHD 25S

SUPER HEAVY-DUTY

ITEM NO.	PRODUCT	JARVIS NO.	EACH
3028 77291	PAS-CSHD 25S, Super Heavy-Duty Bolt .25 Cal	4144059.	CALL FOR PRICING

PAS-CSHD

Suggested Cartridges: Caliber .25S

ITEM NO.	DESCRIPTION .25 CALIBER	ROUNDS/PKG	CARTRIDGES	JARVIS NO.	APPLICATIONS
3028 77315	Red Cartridge, 6 Grain	1,000	.25R	1176025	
3028 35735	Red Cartridge, 6 Grain	50	.25R	1176026	
3028 35555	Black Cartridge, 4 Grain	1,000	.25S	1176034	
3028 35845	Black Cartridge HMF, 5 Grain (Lead Free)	1,000	.25S	1076036	



CAUTION: Do not exceed cartridge strength for prescribe usage.

JARVIS®

MADE IN USA

ITEM NO.	JARVIS NO.	DESCRIPTION	QTY. REQ.	
101	3028 77071	3116001	Breech Housing	1
101A	3028 37191	3116029	Breech Housing, HD	1
102	3028 77451	1171437	Extractor .25 Caliber	1
103	3028 77321	1102673	Breech Cover	1
104	3028 77571	1114224	Trigger Spring	1
105	3028 77331	1118176	Trigger	1
106	3028 77171	1110637	Firing Pin	1
107	3028 77211	1114225	Firing Pin Spring	1
108	3538 00221	410947	Safety O-Ring	1
109	3028 77371	1171436	Outer Safety Cap	1
110	3028 77891	1110006	Safety Roll Pin	1
111	3538 00211	410924	Pull Lock O-Ring Washer	1
112	3028 77471	1171434	Firing Pin Pull	1
113	3028 77531	1114227	Pull Buffer	1
114	3028 77621	1136408	Pull Bushing	1
115	3028 77351	1171435	Inner Safety Cap	1
116	3028 77551	1136409	Pull Split Bush (pair)	1
117	3538 00201	410908	Small O-Ring	1
118	3028 77101	1116857	Breech Cap	1
118A	3028 36931	1116012	Breech Cap, HD	1
119	3028 78141	1114226	Plunger Spring	1
120	3028 77691	1139086	Extractor Plunger	1

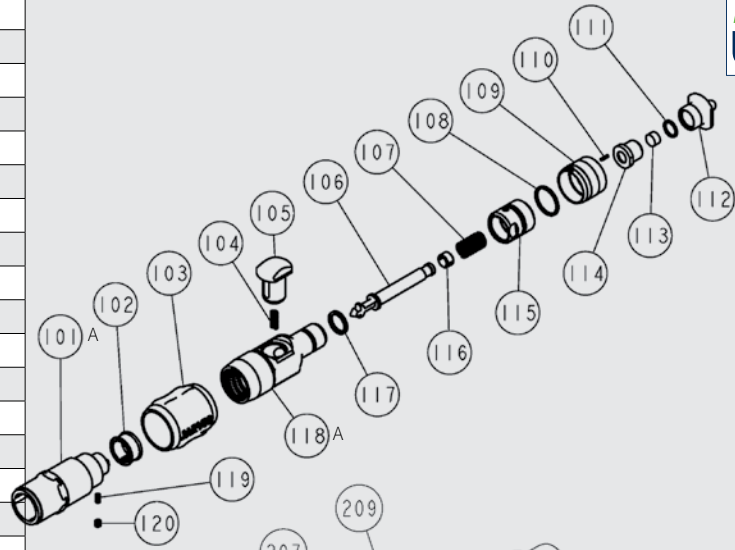

PAS-CL 25S
Long Bolt

PAS-CS 25S
Standard Bolt

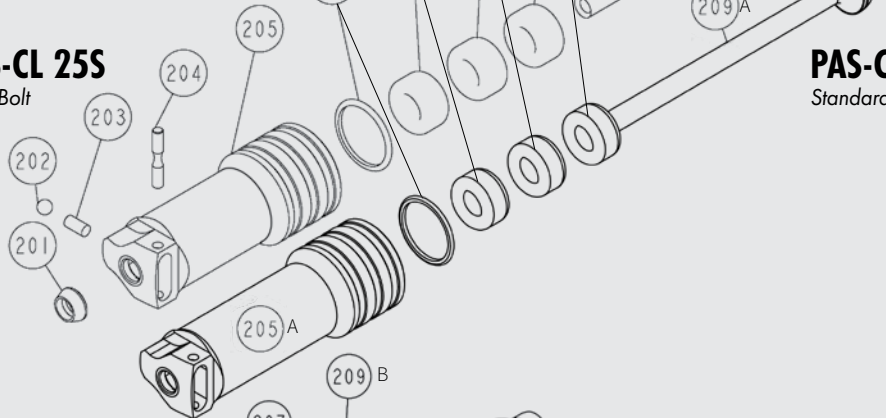

PAS-CSHD 25S
Super Heavy-Duty, Standard Bolt

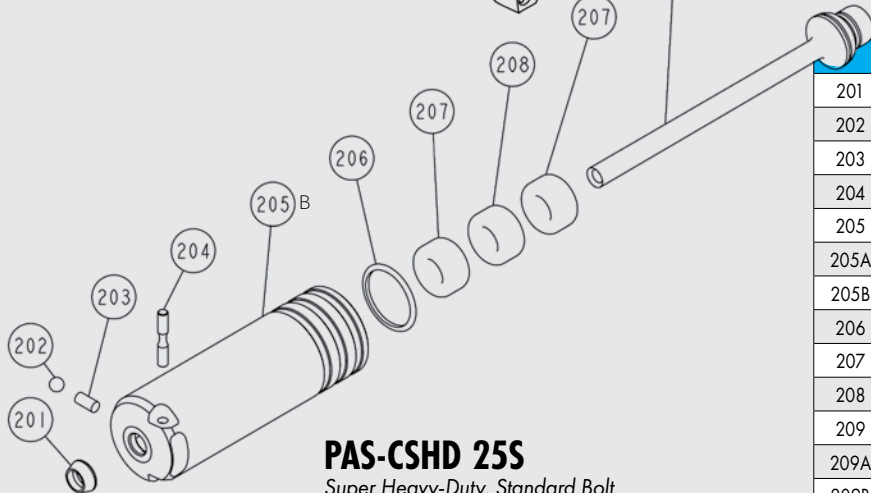

ITEM NO.	JARVIS NO.	DESCRIPTION	QTY. REQ.	
201	3028 77341	1109202	Collar	1
202	3028 77521	1171438	Collar Ball	1
203	3028 77561	1114228	Collar Spring	1
204	3028 77421	1110583	Collar Retaining Pin	1
205	3028 77161	1116855	Barrel/Nosepiece Standard	1
205A	3028 77611	1116001	Barrel/Nosepiece Long	1
205B	3028 78181	1116003	Barrel/Nosepiece HD	1
206	3028 77361	1104509	Barrel Lock Washer	1
207	3028 77111	1171432	Black Buffer, Soft	1
208	3028 77251	1171433	Red Buffer, Soft	1
209	3028 77031	1120459	Stunning Rod, Standard	1
209A	3028 77761	1120001	Stunning Rod, Long	1
209B	3028 37001	1120006	Stunning Rod, HD	1

Power Actuated Stunners (PAS) TYPE-C Retractable Long Bolt

- Model: PAS Type C.
- Penetrating Shaft Diameter: 0.45 inches (11.4 mm).
- Bolt Extension TYPE-CL: 4.75 inches (121 mm).
- Control Handle: single trigger, manual operation.
- Automatic Bolt Retraction.
- Overall Dimensions TYPE-CL: 15.97 X 2.04 inches (406 x 52 mm).
- Weight: 7.80 pounds (3.5 kg).

JARVIS®



PAS-CL 25S
LONG BOLT



ITEM NO.	PRODUCT	JARVIS NO.	EACH
3028 48931	PAS-CL 25S, Standard Bolt Stunner	4144057.	CALL FOR PRICING

PAS-CL Suggested Cartridges: Caliber .25

ITEM NO.	DESCRIPTION .25 CALIBER	ROUNDS/PKG	CARTRIDGES	JARVIS NO.	APPLICATIONS
3028 35765	Yellow Cartridge, 2.0 Grain	1,000		1076029	
3028 35785	Yellow Cartridge, 2.0 Grain	50		1176030	
3028 35555	Black Cartridge, 4.0 Grain	1,000		1176034	
3028 35835	Black Cartridge, 4.0 Grain	50		1176035	
3028 35845	Black Cartridge HMF, 4.0 Grain (Lead Free)	1,000		1076036	
3028 35685	Green Cartridge, 4.5 Grain	1,000		1076023	
3028 35715	Green Cartridge, 4.5 Grain	50		1176024	

CAUTION: Do not exceed cartridge strength for prescribe usage.

Chuck Bildstein, BPD's Humane Stunning and Equipment Specialist, has had a working relationship with Dr. Temple Grandin for many years. You will find that much of the equipment mentioned in *The Slaughter of Farmed Animals* can be ordered and purchased from Bunzl Processor Division. As an example, Jarvis stunners are featured prominently in this book – proving once again that Jarvis and BPD offer what many consider to be the best line of stunners in the industry.

JARVIS®



Jarvis Products Corporation is the world's largest producer of meat and poultry processing equipment.

- Made in the USA in Middletown, CT.
- Service — 26 Jarvis Field Service Technicians for in-plant service.
- Support — Expert advice (22 years of experience) for support, troubleshooting and training.
- Availability — Stunners, parts and power loads stocked in warehouses throughout the USA.

The Slaughter of Farmed Animals Practical Ways of Enhancing Animal Welfare

Edited by Temple Grandin and Michael Cockram

This book provides a balance between evidence-based, scientific studies, and down to earth practical advice.

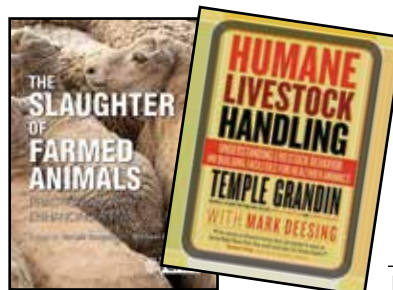

Humane Livestock Handling Understanding Livestock Behavior and Building Facilities for Healthier Animals

By Temple Grandin with Mark Deesing

Humanely handling your livestock can improve the day-to-day operation and profitability of your farm.

ITEM NO.	PRODUCT	EACH
L572 00011	Slaughter of Farmed Animals	\$90.00

ITEM NO.	PRODUCT	EACH
L572 00021	Humane Livestock Handling	\$31.20

	ITEM NO.	JARVIS NO.	DESCRIPTION	QTY. REQ.	
	101	3028 49421	3116624	Breech Housing	1
	102	3028 77451	1171437	Extractor .25 Caliber	1
	103	3028 77321	1102673	Breech Cover	1
	104	3028 77571	1114224	Trigger Spring	1
	105	3028 77331	1118176	Trigger	1
	106	3028 77171	1110637	Firing Pin	1
	107	3028 77211	1114225	Firing Pin Spring	1
	108	3538 00221	410947	Safety O-Ring	1
	109	3028 77371	1171436	Outer Safety Cap	1
	110	3028 77891	1110006	Safety Roll Pin	1
	111	3538 00211	410924	Pull Lock O-Ring Washer	1
	112	3028 77471	1171434	Firing Pin Pull	1
	113	3028 77531	1114227	Pull Buffer	1
	114	3028 77621	1136408	Pull Bushing	1
	115	3028 77351	1171435	Inner Safety Cap	1
	116	3028 77551	1136409	Pull Split Bush (pair)	1
	117	3538 00201	410918	Small O-Ring	1
	118	3028 77101	1116857	Breech Cap	1
	119	3028 78141	1114226	Plunger Spring	1
	120	3028 77691	1139086	Extractor Plunger	1

	ITEM NO.	JARVIS NO.	DESCRIPTION	QTY. REQ.	
	201	3028 38581	1116002	Nose Piece Housing	1
	202	3028 77461	1104509	Nose Piece Lock Washer	1
	203	3028 36071	1104536	Red Bumper Washer	4
	204	3028 77051	1171577	Stunning Rod Bumper	9
	205	3028 77491	1104537	Blue Bumper Washer	1
	206	3028 38591	1120002	Stunning Rod	1

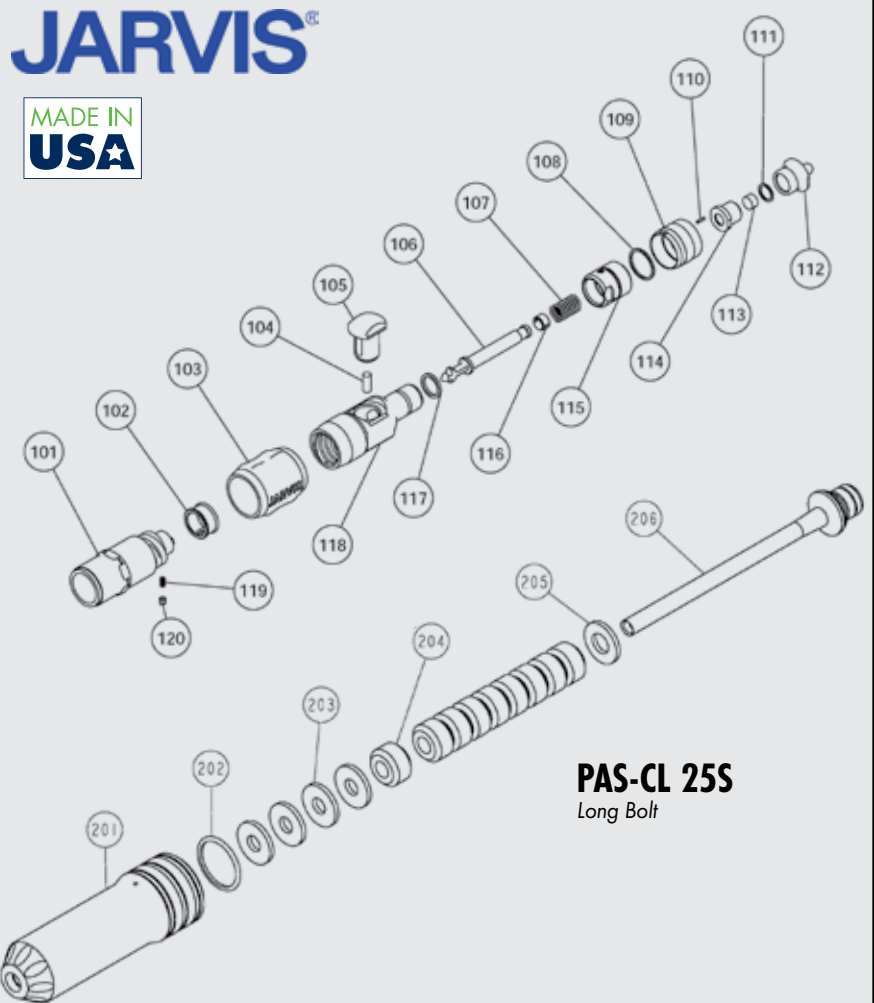

PAS-CL 25S
Long Bolt

Power Actuated Stunner (PAS) Stun Tester

- Fast, accurate device for testing Jarvis® stunners PAS Type-C and Type-P. • Easy to use — intuitive operation.
- Data log for test audits. • Complies with the most stringent requirements for audit data collection.
- Compatible with Type-C and Type-P PAS stunners.



Stun Test Data Records					
Date/Time	Stunner #	Serial #	Power Load Code	Operator ID	SPEED
5/4/2016 8:19	16	110016	7	1234	191
5/4/2016 8:24	16	110016	7	1234	179
5/4/2016 8:38	16	110016	9	1234	196
5/4/2016 9:04	17	110017	7	1235	184

Example of an exportable data log for stun test tracking.

Scan these QR codes with your mobile device to watch videos about the PAS-TYPE P Stunner.

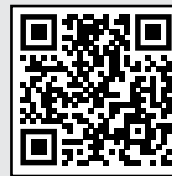

Operation

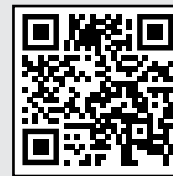

Maintenance



Flip-open protective screen cover.

ITEM NO.	PRODUCT	JARVIS NO.	EACH
3028 35941	Stun Tester	4116001	CALL FOR PRICING

ITEM NO.	PRODUCT	JARVIS NO.	EACH
3028 36541	Stunner Bumper Cushion	1171010	
3028 37491	Pad Grips (Requires 4)	1161006	CALL FOR PRICING
3028 36561	Fiber Optic Sensor (Requires 2)	1163002	CALL FOR PRICING
3028 38911	Cotton Swab Applicator	1161008	

Power Actuated Stunners (PAS) TYPE-C IMPACT FIRE

JARVIS®

MADE IN USA

PAS-CLH IF 25S

LONG HANDLE, HEAVY-DUTY



PAS-C IF 25S

HAND HELD, HEAVY-DUTY

ITEM NO.	PRODUCT	JARVIS NO.	EACH
3028 36471	PAS-C IF HD 25S, Handheld, Heavy Duty	4144072.	CALL
3028 36021	PAS-CLH IF HD 25S, Long Handle, Heavy Duty.	4144071.	FOR PRICING

PAS TYPE C *Suggested Cartridges: Caliber .25S*

ITEM NO.	DESCRIPTION .25S	ROUNDS/PKG	CARTRIDGES	JARVIS NO.	APPLICATIONS
3028 35555	Black Cartridge, 4 Grain	1,000		1176034	

CAUTION: Do not exceed cartridge strength for prescribe usage.

Replacement Parts

	ITEM NO.	JARVIS NO.	DESCRIPTION	QTY. REQ.
101	3028 78351	1102777	Muzzle	1
102	3028 78481	1104560	Nosepiece Lock Washer	1
103	3028 36071	1104536	Red Bumper Washer	3
104	3028 77051	1171577	Stunner Bumper	8
105	3028 77491	1104537	Blue Bumper Washer	1
106	3028 77821	1120535	Stunner Rod	1
107	3028 37201	1116997	Barrel	1
108	3028 78821	1171646	Thread Locking Plug	4
109	3028 37211	1102003	Breech Block	1
110	3028 36401	1110639	Firing Pin	1
112	3028 37221	1110004	Roll Pin	1
113	3028 37231	1109216	Handle Grip	1
114	3028 37301	1119312	Handle	1
115	3028 78401	1153022	Stunner Claw	3
116	3028 78501	1121578	Brass Ball	3
117	3028 37251	1135868	O-Ring	2
118	3028 37261	1109215	Handle Grip	1

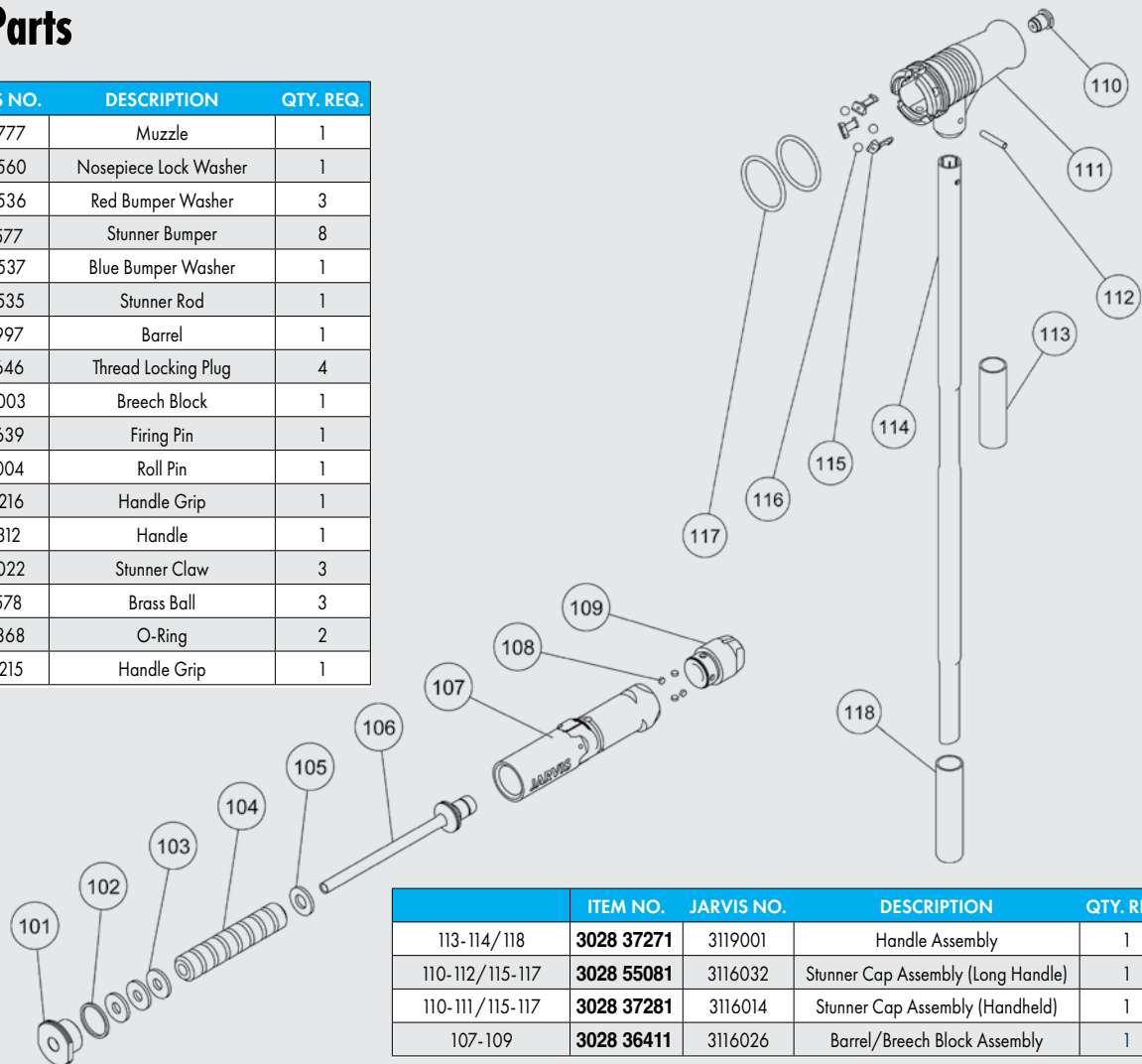

	ITEM NO.	JARVIS NO.	DESCRIPTION	QTY. REQ.
113-114/118	3028 37271	3119001	Handle Assembly	1
110-112/115-117	3028 55081	3116032	Stunner Cap Assembly (Long Handle)	1
110-111/115-117	3028 37281	3116014	Stunner Cap Assembly (Handheld)	1
107-109	3028 36411	3116026	Barrel/Breech Block Assembly	1

Stunner Cleaning Tools

Everything you need to help keep your stunner at its optimum performance.

ITEM NO.	PRODUCT	VENDOR NO.	EACH
3028 36901	A. Hexagon Wrench	8139147	\$6.50
3028 78251	B. Push Rod	8133013	20.71
3028 36261	C. Pick/Pivot Pin	8137019	45.85
3028 77681	D. Undercut Cleaner/Scraper	8137018	139.85
3028 78391	E. Spanner (Wrench)	8130074	43.67
3028 78231	F. 16 mm Cone Wrench	8130076	CALL
3028 78221	G. 14 mm Cone Wrench	8130075	CALL
3028 77751	H. Breech Cleaner	8137017	160.62
3028 36271	I. Manual Extractor/Pry Bar	8132003	40.39
3028 36311	J. Wire Hand Brush	8137020	21.81
3028 36331	K. Roll-Up Tool Pouch	1171638	113.62
3028 36431	L. Steel Cleaning Brush, Small	1171629	13.63
3028 77881	M. Steel Cleaning Brush, Large	1171627	40.39
3028 77831	N. Steel Brush Handle	1119309	46.94
3028 77631	O. Brass Cleaning Brush	1171626	47.76
3028 38071	P. Breech Brush	1171012	16.34
3028 38001	Q. Cotton Cleaning Brush	1171013	20.71
3028 38011	R. Brass Brush Handle	1119002	67.71
3028 77861	S. Anti-Seize Thread Grease, 4 oz.	1162047	39.29
E775 00961	T. Gun Oil, Cleaning Solvent, 4 oz.	1054	19.15
3948 0096	U. Gun Oil, Cleaning Solvent, 12 oz.	410990	31.09
3028 44031	V. Sharpening Tool	8104099	CALL*

* Call for consultation before ordering.

NOTE: We highly recommend using G96 when cleaning your stunner!

Cleaning Tool Kit

- Includes 1 each of tools A-K shown.

ITEM NO.	PRODUCT	JARVIS NO.	EACH
3028 36241	Cleaning Tool Kit	.3161006	\$683.07



SHOP bunzlpd.com 24/7

Where you can find out what's on sale, find updated product information, reviews and pricing.

STAY CONNECTED WITH US:



Need Help?
Chat With Us
Online!



HPS-1 Non-Penetrating Air-Powered Stunner

Non-penetrating euthanasia stunner for small livestock and poultry.

- Practical for use on small pigs, turkeys, rabbits, ostriches, fish, ducks, goats, sheep and geese.
- Can be used with either an easily changeable 12-ounce CO₂ cylinder (providing over 150 shots), portable high-pressure air tank or connected to an air compressor.
- Adjustable impact pressure handles different sizes of animals.
- Single trigger control makes for comfortable handling and operation.
- Light-weight, easy-to-clean and repair.

JARVIS®

MADE IN USA



Scan these QR codes with your mobile device to watch videos about the HPS-1 Stunner.



How to operate.



Disassembly and Reassembly

ITEM NO.	PRODUCT	JARVIS NO.	EACH
3028 43171	HPS-1 Stunner	4044131.	
3028 47171	HPS-1 Tool, Air Operation Only	4044138.	
3028 49211	HPS-1 Tool with Small Knockerhead	4044158.	CALL FOR PRICING
3028 47041	HPS-1 Tool, Preset to 140 psi (Turkey)	4044145.	CALL FOR PRICING
3028 49511	HPS-1 Air Only Adapter Kit	1042897.	
3028 49961	HPS-1 Complete O-Ring Kit	3035149.	
3028 48011	Firing and Supply Valves, Steel	1022527.	

USSS-BBS Non-Penetrating Pneumatic Stunner

Unique design renders the stunned animal insensible to pain without penetrating the skull.

- The longer housing gives the rod 0.65 inches more free travel before it leaves the head contact.
- Easy to handle and operate for less operator fatigue and more accurate head contact.
- The air chamber is 1-1/2 inches longer giving 30% more available air when fired.
- Valve body is larger and has a larger valve which provides more air flow.
- Stunning rod has a larger 3-1/4-inch piston.
- One shot humane stunning procedure.
- Better stunning for improved meat quality.
- Easy to maintain, clean and repair.

JARVIS®

MADE IN USA

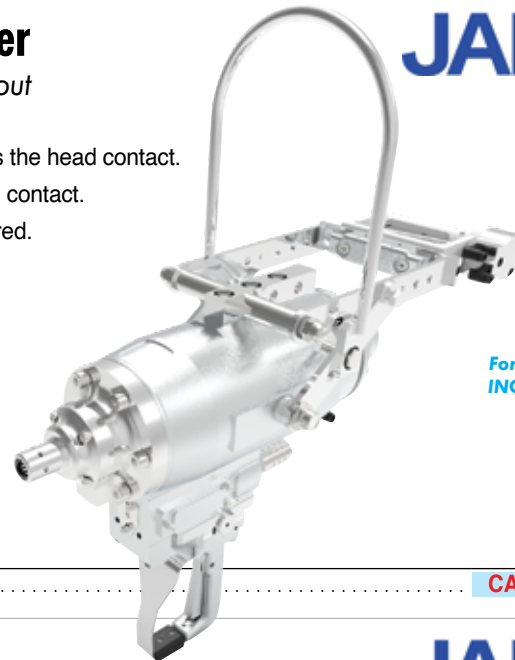

▶ SEE PAGE 429
For Packers Kromer™
INOX PRO® Balancers

ITEM NO.	PRODUCT	JARVIS NO.	EACH
3028 53211	USSS-BBS Stunner	4044154.	CALL FOR PRICING

USSS-21 Pneumatic Stunner

- Newly designed, lighter weight oblong shaped stunning rod for easier skull penetration and 15 to 20% faster bolt speed.
- More efficient, uses 25% less air with no performance loss.
- Two different firing sequences — less chance of activating stunner accidentally.
- Redesigned auxiliary handle that rotates to operator's preference.
- Easy to handle, repair, maintain, and clean.
- Improved ergonomic handle design for less operator fatigue, and controlling possible injuries.

JARVIS®

MADE IN USA



▶ SEE PAGE 429
For Packers Kromer™
INOX PRO® Balancers

ITEM NO.	PRODUCT	JARVIS NO.	EACH
3028 44681	USSS-21 Stunner	4044132.	CALL FOR PRICING

USSS-1/2 Penetrating Pneumatic Stunner

Renders stunned animal insensible to pain.

- One shot humane stunning procedure. Fires only once — no multiple firing.
- Better stunning for improved meat quality.
- Air operated with no air injection.
- Easy to handle and safe to operate.
- Low recoil or kick back.
- Lightweight tool only weighs 15.5 pounds (7.03 kg).
- Easy to handle, repair and clean.

JARVIS®

MADE IN USA

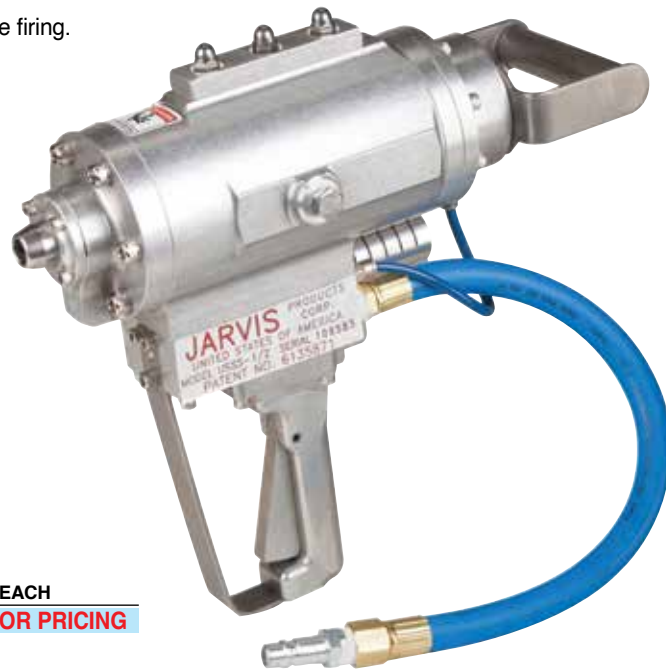

ITEM NO.	PRODUCT	JARVIS NO.	EACH
3028 38021	USSS-1/2 Stunner	4044042	CALL FOR PRICING

AST-107 Pneumatic Stunner Tester

Fast, accurate testing of the USSS-21 Stunner.

- Data logs accurate USSS-21 testing (firing speed, expected velocity and test pressure).
- Complies with most stringent requirements or audit data collections.
- Detachable nose guide.
- Easy-to-use — intuitive operation.

JARVIS®

MADE IN USA



Shown with USSS-21 stunner in place.



Detachable nose guide.

ITEM NO.	PRODUCT	JARVIS NO.	EACH
3028 44691	AST-107 Stunner Tester	4016015	CALL FOR PRICING

KnockerVest™ with Detachable Groin Protector

Designed for body protection while using stunning equipment.

- 100% aramid ballistic package (type IIIA) backed with 1/2-inch closed-cell foam and inserted in a 1,000 denier Cordura carrier vest which is coated with a urethane film for even more water resistance.
- Water-resistant carrier vest meets the highest standards for soft body armor.
- Back of vest is made of a tough, breathable open nylon mesh that is made to withstand multiple washings.
- All fasteners are quick-release with adjustable straps and plastic buckles to ensure a great fit.
- Outer shell carrier units may be hand or machine washed with mild detergent and air dried.
- Groin protector and cover are both sold separately.

ITEM NO.	PRODUCT	SIZE/LENGTH	EACH
4009 25891	KnockerVest™	Medium	\$549.95
4009 0102	KnockerVest™	Large	549.95
4009 0103	KnockerVest™	X-Large	549.95
4009 0115	KnockerVest™	2X-Large	779.10
4009 51761	KnockerVest™	5X-Large	885.00
4009 0104	Groin Protector Pad w/Black Cover and 3-Snap Attachment		279.95
4009 0010	Replacement Black Cover for Groin Protector		159.95



Breathable nylon mesh back.



Chest ballistics protection is easily removed to clean vest.



Easily detachable groin ballistics protection.

NOTE: No claim made or implied the KnockerVest™ can or will protect users from impact by a non-deforming projectile. KnockerVests will not resist pointed tools or knives. Read product specifications carefully before use.



KnockerVest™ is a trademark of JHRG Manufacturing LLC.

Stainless Steel Foot Protectors

- For best protection, the guard should be positioned so that it rests upon the steel toe of shoe or boot.
- Stainless steel shell with aluminum rivets.
- For use on Mens' shoes/boots sizes 6-13.



ITEM NO.	PRODUCT	F.O.B. FACTORY PAIR
5140 2101	A. Foot Protector for Shoes w/Laces	\$49.95
5140 0107	B. Foot Protector for Shoes w/o Laces	56.81



NOTE: Sold per pair.

Rattle Paddles

The humane way to move livestock.

- BBs in paddle create a pervasive "rattle" sound.
- Vinyl tubing encases stick eliminating, shattering or splintering.
- Reinforced paddle head for maximum durability.
- Pop rivets secure paddle to shaft.
- Shorter neck puts less stress on paddle head.
- Paddle head dimensions: 12-1/2 inches L x 5-1/2 inches W.
- Golf club grip.



NOTE: Available in yellow, red, green, blue or black. Color CANNOT be specified.

ITEM NO.	PRODUCT	EACH
C933 30431	42" Rattle Paddle	\$15.43
C933 30491	48" Rattle Paddle	16.46
C933 21001	Replacement Paddle Head	6.14
3106 60251	Replacement BB's (Bulk Bottle of 6,000)	25.96



Yellow DuraProd™ Cattle Prod

The next generation of prod technology.

- New patent pending “circuit isolation technology” reduces feedback shock. • Low amps prevent burning.
- New handle design with rubber grip, oversized trigger and hand guard. • Built-in safety switch.
- Sealed motor can't be damaged by dirt or moisture. Flexible shaft. • Nickel plated contacts. • Easy-to-clean.
- Rechargeable battery and charger also available.



NOTE: HOT-SHOT Rechargeable Battery Pack Available. CALL FOR DETAILS.

ITEM NO.	PRODUCT	EACH
4173 10321	32" Overall Length, Yellow.	\$268.00
4173 39501	Rechargeable Battery	108.65
4173 00181	Battery Charger & Base	81.95



Flexible shaft can withstand 180° bend.

Red Sabre-Six™ Cattle Prod

Effective on all types of animals — even wet.

- Low amps prevent burning. • Gives more spark and effective power to move stubborn animals.
- Sealed motor can't be damaged by dirt or moisture. • Nickel-plated contacts in shaft. • Easy-to-clean.
- Battery operated, uses six C batteries (sold separately). ➔



For Batteries
▶ See page 366

ITEM NO.	PRODUCT	EACH
4173 00141	36" Overall Length, Red	\$109.72
4173 0306	36" Replacement Shaft	28.75



NOTE: HOT-SHOT Rechargeable Battery Pack Available. CALL FOR DETAILS.

NOTE: 48-inch prods also available. CALL FOR DETAILS.

Green HS236 Cattle Prod

Suitable for use in all conditions – even on wet animals.

- Low amps prevent burning. • Easy-to-clean. • Commercial strength, heavy-duty prod with fiberglass shaft.
- Sealed motor can't be damaged by dirt or moisture. • High output with low battery drain.
- Instant On/Off with no hold-over shock. • Battery operated, uses six C batteries (not included). ➔

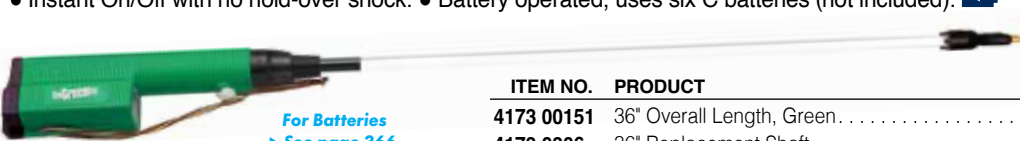

For Batteries
▶ See page 366

ITEM NO.	PRODUCT	EACH
4173 00151	36" Overall Length, Green.	\$163.32
4173 0306	36" Replacement Shaft	28.75



NOTE: HOT-SHOT Rechargeable Battery Pack Available. CALL FOR DETAILS.

NOTE: 48-inch prods also available. CALL FOR DETAILS.

110 mm Dehider Blades

- For use on cattle, veal, hogs and sheep.
- Skins perfectly: no cuts, marks, or holes.
- Compatible with JC-III and JC-IV model dehiders.



ITEM NO.	PRODUCT	JARVIS NO.	PAIR
3028 0155	110 mm Dehider Blades	3023011.	\$237.63

Pneumatic Powered Circular Saw



CALL 800-456-5624
For pricing and details about JARVIS EQUIPMENT



ITEM NO.	PRODUCT	OEM#	JARVIS NO.	EACH
3028 1254	Air Power Circular Saw	4001028 SPC-165	4001028.	CALL
3028 87071	30" Air Hose Assembly	3059018.	\$232.89

Hand-Held Pneumatically Powered Dehiders

The world standard for skinning tools.

- The #1 skinning tool worldwide for cattle, veal, hogs and sheep.
- Super efficient motor design.
- Highest possible hide quality — skins perfectly; no cuts, marks, or holes.
- High capacity, high performance tool, designed for long life, and low maintenance.
- Extra-thin head with stainless steel center plate for exceptional handling and enduring strength.

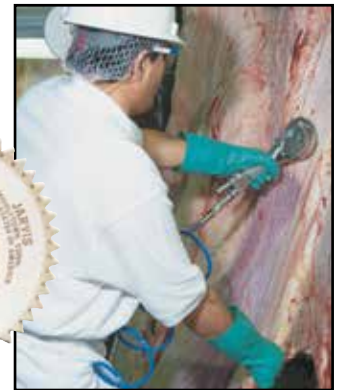

Scan this QR code with your mobile device to watch the dehider in action on our YouTube channel.

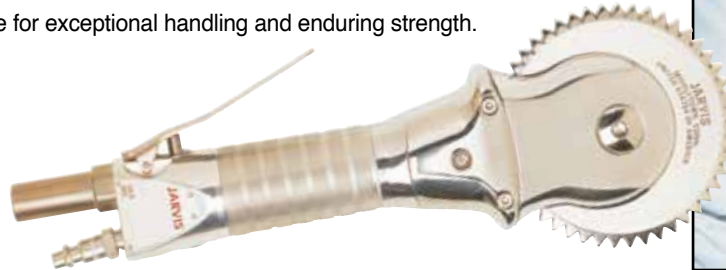

ITEM NO.	PRODUCT	MOTOR	OPERATING PRESSURES	AIR CONSUMPTION	BLADE SPEED/MIN	OVERALL LENGTH	WEIGHT	JARVIS NO.	EACH
3028 4036	JC IIIA	0.55 hp	45 psi	12 CPM	6,500 - 7,000	13-in.	2.9 lb	4034036	CALL FOR PRICING
3028 9038	JC IIIA	0.55 hp	90 psi	12 CPM	6,500 - 7,000	13-in.	2.9 lb	4034060	\$90.95
3028 41801	JC IVA	0.70 hp	45-50 psi	15 CPM	6,500 - 7,000	13-in.	3.1 lb	4034038	137.22
3028 39311	Air Hose, Straight with Female Disconnect					16"		1059002	
3028 90481	Air Hose, Coiled with Female Disconnect					15"		3059047	



SIGN UP FOR OUR eDEALS

eDEAL SIGN-UP FORM AVAILABLE ON OUR WEBSITE.

www.bunzlpd.com

Hand-Held Pneumatic Skinner



Jarvis' Handheld Pneumatic Skinner for removing skin and fat from pork, beef, poultry and fish carcasses.

- Specially designed for fast and efficient removing of trimming strips, rounds, butts, hindquarters and loins from pork carcasses.
- Low cost skinning of boars and sows with uniform, controlled depth removal of skin and fat.
- Also useful for ham trimming and de-fatting, fish skinning, removing chicken breast skin and trimming turkey membranes.
- Provides clean, uniform skin removal without knife cuts or gashes.
- Easy to operate, clean and maintain.
- Adjustable 360° rotating handle for comfortable handling.
- Also available in 1/16 inch and 3/16 inch. Call for more information.



NOTE: Use with air hoses listed above.

ITEM NO.	PRODUCT	CUTTING DEPTH	JARVIS NO.	EACH
3028 45861	JHSL-330	1/8"	4034128	CALL FOR PRICING

Packers Kromer™ INOX PRO® Zero Gravity Balancers

Designed specifically for the food industry.

- Reduce worker fatigue, safety hazards and tool/air hose damage while allowing for improved accuracy and production volume.
- For use in the ergonomic placement of production tools.
- High-strength anti-rotation steel cable with rubber buffer and screw-type spring hook for load suspension.
- Precise stepless tension and load adjustment for zero-gravity balancing.
- High-strength, riveted cold rolled steel spring for 5 times the spring life.
- Superb German craftsmanship. • Locking safety hook.
- Freely rotatable and swiveling suspension.
- Many beneficial features, including: High impact nylon or uncoated, high-strength aluminum housing.; Stainless steel cable.; Automatic safety detent.; Easy load leveling.; Safety drum lock.; Quick change cable.; Stainless steel safety chain included.; Easy spring change.

Medium-Duty

Model 7230

- Cable Travel: 6.5 feet (2 m).
- High-impact orange nylon housing.

ITEM NO.	MFR. NO.	WORKING LOAD (lb/kg)
1968 01501	7230000133. . .	13.3-22 pounds/6-10 kg
1968 01531	7230000134. . .	20-30 pounds/9-14 kg
1968 01601	7230000135. . .	28.7-37 pounds/13-17 kg
1968 01541	7230000136. . .	35.2-46.3 pounds/16-21 kg



FOUR IMPORTANT STEPS TO DETERMINE WHICH BALANCER IS RIGHT FOR YOU:

1. Tool weight including accessories.
2. Balancer load range (best performance in mid to upper load range).
3. Travel (distance tool moves during operation).
4. Overhead space for balancer to hang.

Retractors

Retracting force increases with increasing cable extension, automatically retracting working load (tool) to its initial position after use.

- High-strength anti-rotation steel cable with elastic cable stop buffer and screw-type spring hook for load suspension.
- High-impact orange nylon housing.
- High-strength riveted cold rolled steel spring for 5 times the life.
- Spring is not replaceable.



A

A. Light-Duty Model 7211 Cable Travel: 8.2 feet (2.5 m).

ITEM NO.	MFR. NO.	WORKING LOAD (lb/kg)
1968 01251	7211080131. . .	1.1-4.4 pounds/0.5-2 kg
1968 01441	7211080132. . .	3.3-6.6 pounds/1.5+3 kg

B. Medium-Duty Model 7221 Cable Travel: 9.8 feet (3 m).

ITEM NO.	MFR. NO.	WORKING LOAD (lb/kg)
1968 01451	7221080131. . .	4.4-11 pounds/2-5 kg
1968 01461	7221080132. . .	8.8-17.6 pounds/4-8 kg
1968 01481	7221080133. . .	15.4-22 pounds/7-10 kg
1968 01491	7221080134. . .	22-30 pounds/10-14 kg



B

Packers KROMER™

INOXPRO®
Zero Gravity Balancers

Heavy-Duty

Model 7241

- Cable Travel: 6.5 feet (2 m).
- High-impact aluminum housing.

ITEM NO.	MFR. NO.	WORKING LOAD (lb/kg)
1968 01651	7241080131. . .	26-44 pounds/12-20 kg
1968 01401	7241080132. . .	44-66 pounds/20-30 kg
1968 01261	7241080133. . .	66-99 pounds/30-45 kg
1968 01281	7241080134. . .	99-132 pounds/45-60 kg
1968 01291	7241080135. . .	132-165 pounds/60-75 kg
1968 01301	7241080136. . .	165-198 pounds/75-90 kg
1968 01311	7241080137. . .	198-220 pounds/90-100 kg



Double spring model shown.

Heavy-Duty

Model 7251

- Cable Travel: 9.8 feet (3 m).
- High-impact aluminum housing.

ITEM NO.	MFR. NO.	WORKING LOAD (lb/kg)
1968 01321	7251080101. . .	33-55 pounds/15-25 kg
1968 01331	7251080102. . .	55-77 pounds/25-35 kg
1968 01341	7251080103. . .	77-110 pounds/35-50 kg
1968 01351	7251080104. . .	110-143 pounds/50-65 kg
1968 01361	7251080105. . .	143-176 pounds/65-80 kg
1968 01371	7251080106. . .	176-198 pounds/80-90 kg
1968 01431	7251080036. . .	180-209 pounds/82-95 kg
1968 01381	7251080107. . .	198-220 pounds/90-100 kg
1968 01391	7251080108* . . .	220-253 pounds/100-115 kg
1968 01421	7251080109* . . .	253-286 pounds/115-130 kg
1968 0050	7251080110* . . .	286-308 pounds/130-140 kg
1968 0051	7251080111* . . .	308-330 pounds/140-150 kg

* Double spring models.

	ITEM NO.	JARVIS NO.	DESCRIPTION	REQ. REQ.
1	3028 0025	1063112	Brush Cap	2
2	3028 0024	1063111	Brush and Spring	2
3	3028 0023	1063110	Brush Holder	2
4	3028 0046	1015006	Deflector	2
5	3028 0009	1002191	Top Cap	1
6	3028 7083	1017083	Danger Label	1
7	3028 0039	1055428	Screw, Flat Head	4
8	3028 0043	1021215	Ball Bearing	1
9	3028 0022	1063119	Stator 115 V	1
	3028 3120	1063120	Stator 230 V	1
10	3028 0019	1027040	Stator Stud	2
11	3028 0036	1007164	Lock Nut	4
12	3028 0020	1063117	Armature, 115 V	1
	3028 0021	1063118	Armature, 230 V	1
13	3028 0047	1026072	Pinion Gear, LH Thread	1
14	3028 0063	1021227	Ball Bearing	1
15	3028 0032	1035193	Seal	1
16	3028 0028	1035192	Seal	2
17	3028 0017	1036116	Bushing	1
18	3028 0029	1027041	Drive Stud	1
19	3028 0035	3065010	Push Rod and Stud	1
20	3028 2050	1012050	Clamp Ring	1
21	3028 0061	1055422	Set Screw 1/4"	1
22	3028 0037	8030031	Hex Key	1
23	3028 0010	1002206	Blade Support Cover	1
24	3028 0050	1007162	Cap Nut	6
25	3028 0041	1055439	Screw, Oval Head Phillips	2
26	3028 42421	1054076	Screw, Coated	3
27	3028 1693	1002203	Handle Cover	1
28	3028 0006	1005038	Switch	1
29	3028 34631	1073190	Screw, Round Head	2
30	3028 0096	1012046	"S" Clip	1
31	3028 0097	1012047	"U" Clip (Rubber)	1
32	3028 0049	1027048	Stud	3
33	3028 0048	1036120	Insert Bushing	3
36	3028 0045	1004149	Thrust Bearing Race	1
37	3028 0044	1021218	Needle Thrust Bearing	1
38	3028 0056	1027043	Drive Stud	1
39	3028 0136	3026024	Gear and Stud (Item 38)	1
40	3028 0026	1020133	Gear Shaft, LH Thread	1
41	3028 1737	1021228	Needle Bearing	2
42	3028 0015	1035191	Gasket	1
43	3028 0012	1002193	Bottom Plate	1
44	3028 0038	1055426	Screw, Set of 12	4
45	3028 0016	3028030	Connecting Rod and Bearing	1
46	3028 0033	1029185	Spacer	1
47	3028 3310	1013310	Snap Ring	1
48	3028 0058	1021216	Needle Bearing	2
49	3028 5454	1055454	Screw, Round Head	1
50	3028 0013	3001008	Cord and Plug, 115 V	1
51	3028 0060	1013137	Clamp Ring	1

Wellsaw 404 Replacement Parts

JARVIS®

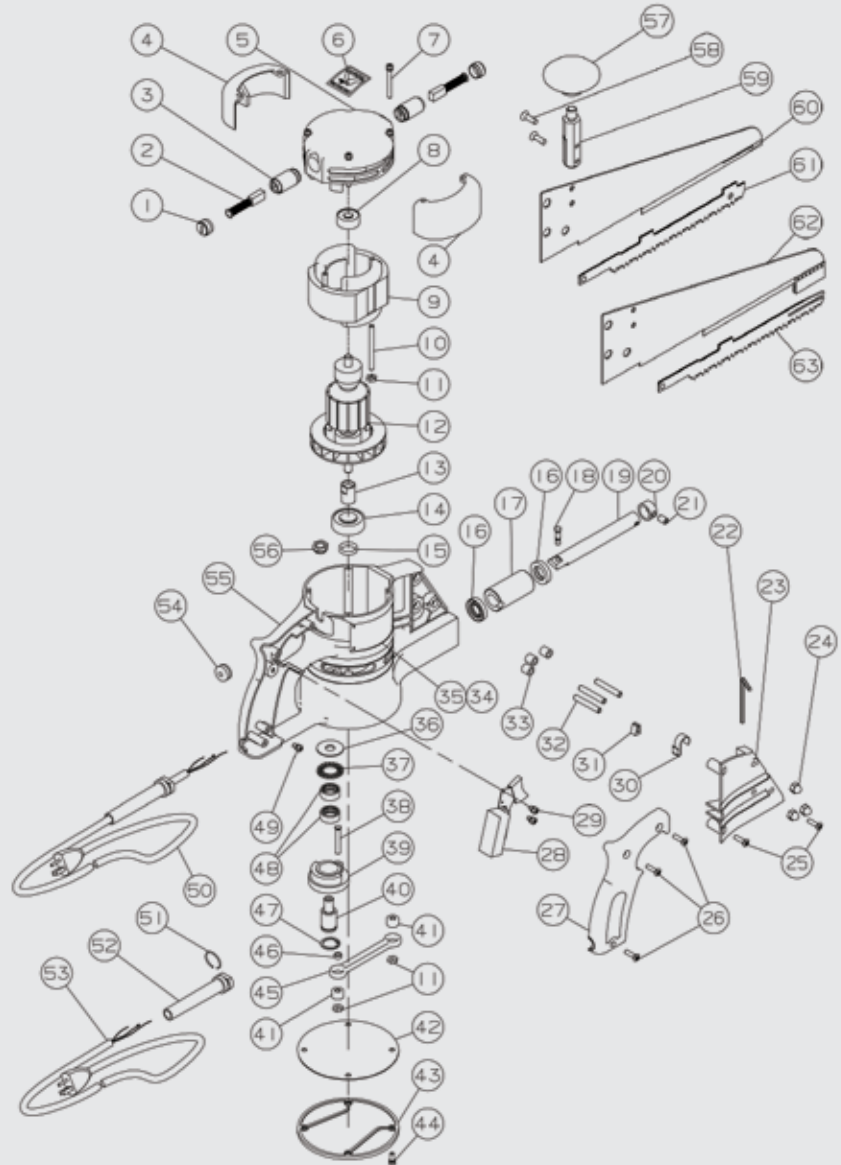

We are a full-line stocking distributor for Jarvis® replacement parts and blades for all Jarvis® tools.

	ITEM NO.	JARVIS NO.	DESCRIPTION	REQ. REQ.
52	3028 0059	1063125	Strain Relief	1
53	3028 1762	3001011	Cord w/o Strain Relief, 230 V	1
54	3028 3109	1063109	Grommet	1
55	3028 0062	1016199	Housing	1
56	3028 0137	1007166	Gear Stud Nut	1
57	3028 6021	1006021	Knob	1
58	3028 0042	1055429	Screw, Oval Head Phillips	2
59	3028 0030	1027042	Handle Stud	1

Wellsaw 404

8,000 strokes per minute, 1 hp.

- Heavy-duty 1 hp motor 115 V AC single phase. • Quick action double-pole trigger switch.
- Weight: 11 pounds. • 10-foot heavy-duty, grounded 3-wire power cord.
- Reciprocating blade design allows cutting on both strokes at the rate of 8,000 strokes per minute, with a 1-1/8 inch stroke length.
- Teflon coated blade support.

JARVIS®

Complete saw shown here.

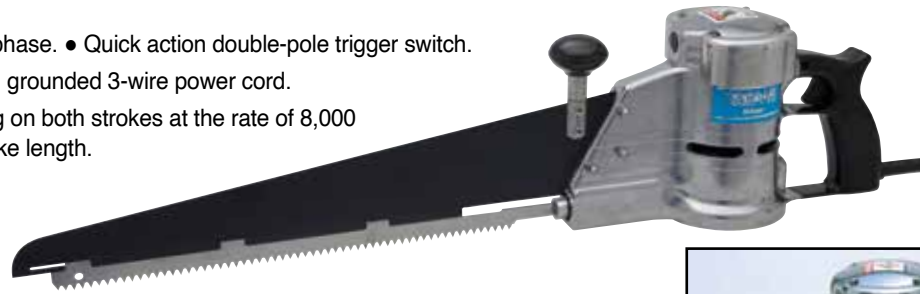

NOTE: Order blades and blade supports separately. SEE BELOW.

Wellsaw 404 Meat Saw Motor Drive

PURCHASE THE WELLSAW 404 SERVICE KIT (SHOWN BELOW) AT THE SAME TIME!

ITEM NO.	PRODUCT	EACH
3028 6127	Wellsaw 404 Motor Drive - Assembly Only	\$961.65



Wellsaw 404 Blades and Supports

Blades

ITEM NO.	PRODUCT	EACH
3028 3122	8" Blade	\$32.51
3028 31211	16" Blade	55.71
3028 3123	8" Heavy-Duty Blade	35.62
3028 31241	16" Heavy-Duty Blade	57.32

Supports

ITEM NO.	PRODUCT	EACH
3028 8071	8" Blade Support	\$81.34
3028 8070	16" Blade Support	123.09
3028 8075	8" Heavy-Duty Blade Support	127.63
3028 8074	16" Heavy-Duty Blade Support	162.97

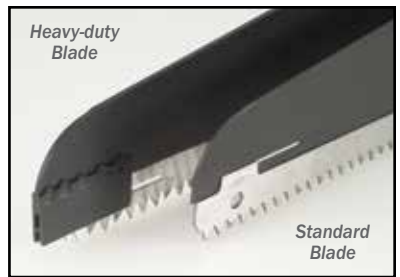

Wellsaw 404 Service Kit

- We recommend a service kit be ordered with every Wellsaw 404.
- Contains these recommended spare parts to service saw: switch, screw, stud, hex key, grease, pinion gear and bottom plate gasket.

ITEM NO.	PRODUCT	EACH
3028 11521	Wellsaw 404 Service Kit	\$116.00



Wellsaw 404 Replacement Parts, Continued

BLADES AND SUPPORTS				
	ITEM NO.	JARVIS NO.	DESCRIPTION	QTY. REQ.
60	3028 8071	1058071	8" Blade Support, End Cut	1
	3028 8070	1058070	16" Blade Support, End Cut	1
61	3028 3122	1023122	8" Blade, End Cutting	1
	3028 31211	1023121	16" Blade, End Cutting	1
62	3028 8075	1058075	8" Blade Support, HD	1
	3028 8074	1058074	16" Blade Support, HD	1
63	3028 3123	1023123	8" Blade, HD	1
	3028 31241	1023123	16" Blade, HD	1
	3028 0179	1023124	Gear Grease, 1 lb Can	1

REPLACEMENT KITS			
	ITEM NO.	JARVIS NO.	DESCRIPTION
	3028 0064	3063007	Armature, Bearing and Pinion Gear, 115 V
	3028 3013	3063013	Armature and Pinion, 115 V
	3028 0034	3026023	Gear and Bearing Assembly
	3028 6119	3016119	Housing, Seals and Bushing Assembly (Items 15-17, 55)
	3028 11521	3061152	Service Kit (Items 11, 13, 21, 28, 29, 38 and 42)

JARVIS®

DID YOU KNOW WE OFFER REPAIR SERVICE FOR WELLSAWS? Call for details.

	ITEM NO.	JARVIS NO.	DESCRIPTION	QTY. REQ.
1	3028 5948	1055948	Socket Head Cap Screw	4
2	3028 4095	1024095	Guard Exhaust	1
3	3028 0041	1055439	Oval Head Screw	7
4	3028 0066	1061188	Tie Bar	1
5	3028 0067	1002198	Cover Plate	1
6	3028 5454	1055454	Round Head Screw	2
	3028 0040	1055438	Set of 12 Screws	
7	3028 0068	1055434	Button Head Screw	1
8	3028 0069	1055431	Oval Head Screw	6
9	3028 2194	1002194	Bearing Cap	1
10	3028 0071	1035198	Gasket	1
11	3028 0074	1016200	Gear Housing	1
12	3028 0075	1063121	Strain Relief	1
13	3028 0076	1012048	Clamp Bar	1
14	3028 0079	1001028	Power Cord Set 115 V	1
	3028 0080	1001029	Power Cord Set 230 V	1
15	3028 0078	1055430	Fillister Head Screw	2
16	3028 0077	11035194	Seal	1
17	3028 0072	1055436	Set Screw	3
18	3028 0006	1005038	Switch	1
19	3028 34631	1073190	Round Head Screw	2
20	3028 0084	1063124	Insulator	1
21	3028 0083	1002195	Handle Cover	1
22	3028 5452	1055452	Flat Head Screw	11
	3028 0038	1055426	Set of 12 Screws	
23	3028 2196	1002196	Bottom Plate	1
24	3028 0082	1035196	Bottom Plate Gasket	1

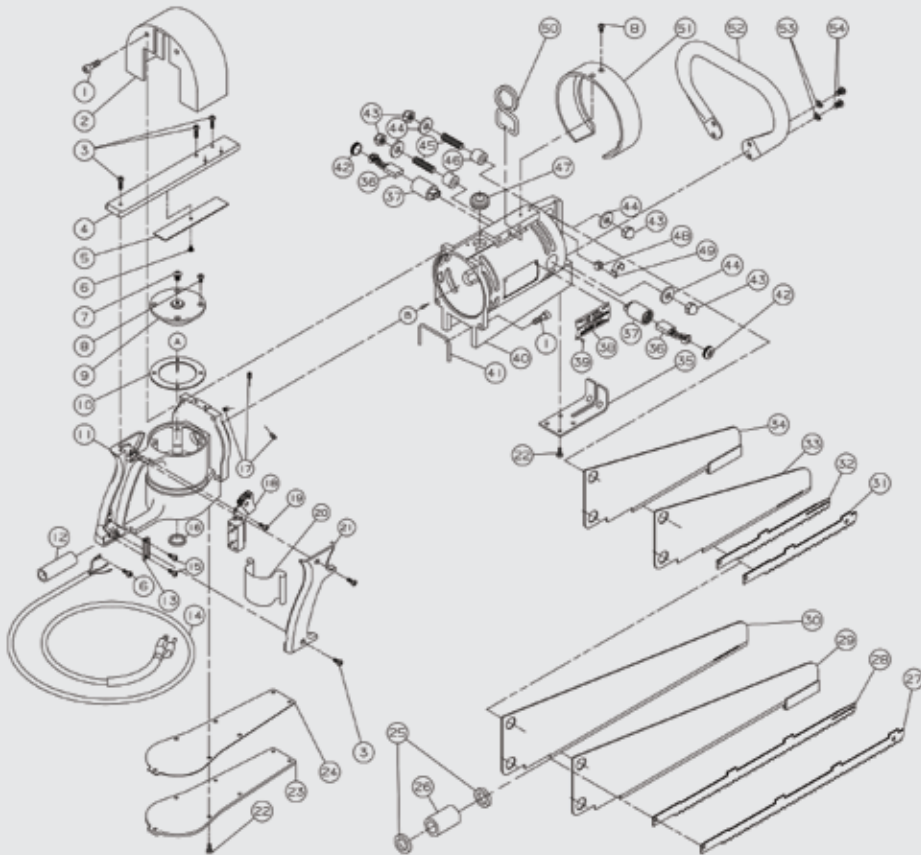

JARVIS®

Wellsaw 444 Replacement Parts

	ITEM NO.	JARVIS NO.	DESCRIPTION	QTY. REQ.
25	3028 0115	21035195	Seal	2
26	3028 0116	1036118	Bushing	1
35	3028 0095	1024060	Blade Guard	1
36	3028 0089	3063009	Brush and Spring Assembly	2
37	3028 0088	1063122	Brush Holder	2
40	3028 0087	1016201	Motor Housing and Label	1
41	3028 0086	1035203	Gasket	1
42	3028 0090	1002199	Brush Cap	2
43	3028 0091	1007163	Cap Nut	4
44	3028 0092	1004150	Flat Washer	4
45	3028 0093	1027046	Stud	2
46	3028 0094	1036119	Bushing Insert	2
47	3028 0001	1063123	Grommet	1
48	3028 0097	1012047	"U" Clip	1
49	3028 0096	1012046	"S" Clip	1
50	3028 0098	1001027	Hanging Ring	1
51	3028 0101	1002197	Shroud/Cover	1
52	3028 0099	1019079	Handle (Includes items 53 and 54)	1
53	3028 0100	1004049	Lock Washer	4
54	3028 5069	1055069	Button Head Screw	4

We are a full-line stocking distributor for Jarvis® replacement parts and blades for all Jarvis® tools.

BLADES AND SUPPORTS				
	ITEM NO.	JARVIS NO.	DESCRIPTION	QTY. REQ.
27	3028 31211	1023121	Blade 16", End Cutting	1
28	3028 31241	1023124	Blade 16", 4 TPI, HD	1
29	3028 8072	1058072	Blade Support 16", HD	1
30	3028 8078	1058077	Blade Support 16", End Cut	1
31	3028 3122	1023122	Blade 8", End Cutting	1
32	3028 3123	1023123	Blade 8", 4 TPI, HD	1
33	3028 1696	1058076	Blade Support 8", End Cut	1
34	3028 8073	1058073	Blade Support 8", HD	1

REPLACEMENT KITS			
	ITEM NO.	JARVIS NO.	DESCRIPTION
	3028 0130	3016120	Gear Housing and Seal Assembly
	3028 6121	3016121	Motor Housing and Seal Assembly
	3028 0132	3061069	Drive Shaft Assembly
	3028 1705	3061070	Crank Arm Assembly
	3028 0133	3028031	Connecting Rod and Bearing
	3028 0134	3063005	Armature and Brq Assembly, 115 V
	3028 0179	1062003	Gear Grease, 1 lb
	3028 7083	1017083	Danger Label

Wellsaw 444 Meat Saw

6,300 strokes per minute, 2 hp.

- Heavy-duty 2 hp motor 115 V AC single phase.
- Reciprocating blade design allows cutting on both strokes at the rate of 6,300 strokes per minute, with a 1-1/2 inch stroke length.
- Adjustable ring for overhead counter balance attachment. • Quick action double-pole trigger switch. • Teflon coated blade support.
- 10-foot heavy-duty, grounded 3-wire power cord. • Weight: 26 pounds.



ITEM NO.	PRODUCT	EACH
3028 5252	16" Wellsaw 444 - Complete Unit	\$2,601.10

Includes 16" heavy-duty blade and support.

DID YOU KNOW WE OFFER REPAIR SERVICE FOR WELLSAWS?
Call for details.



Replacement Blades and Supports for Wellsaw 444

Blades

ITEM NO.	PRODUCT	EACH
3028 3123	8" Heavy-Duty Blade	\$35.62
3028 31241	16" Heavy-Duty Blade	57.32

Supports

ITEM NO.	PRODUCT	EACH
3028 8073	8" Blade Support	\$126.57
3028 8072	16" Blade Support	162.97

CALL 800-456-5624 FOR PRICING AND INFORMATION

Wellsaw 444 JARVIS Replacement Parts, Continued

ITEM NO.	JARVIS NO.	DESCRIPTION	QTY. REQ.
55	3028 0112	1055100 Set Screw	3
56	3028 0111	1007165 Lock Nut	1
57	3028 0107	1004127 Thrust Bearing Race	2
58	3028 0110	1028059 Connecting Rod	1
59	3028 0109	1021221 Needle Bearing	1
60	3028 0108	1021223 Inner Race	1
61	3028 0106	1061189 Crank Arm/Counter Weight	1
62	3028 0105	1021230 Ball Bearing	1
63	3028 0104	1020130 Drive Shaft	1
64	3028 0103	1026070 Spiral Bevel Gear	1
65	3028 0102	1021210 Ball Bearing	1
66	3028 0753	1030100 Woodruff Key	1
67	3028 0120	1027044 Drive Stud	1
68	3028 0118	1021222 Inner Race	1
69	3028 0119	1021220 Needle Bearing	1
70	3028 0113	1027045 Rod Stud	1
71	3028 3132	8030032 Hex Wrench	1
72	3028 0114	1055423 Set Screw	1
73	3028 0117	1065026 Push Rod	1
74	3028 0122	1026071 Spiral Bevel Pinion Gear	1
75	3028 1211	1021211 Ball Bearing	1
76	3028 0055	1063113 Armature, 115 V	1
	3028 0124	1063114 Armature, 230 V	1
77	3028 0128	1021209 Ball Bearing	1
78	3028 0036	1007164 Lock Nut	2
79	3028 0125	1012049 Clamp	1
80	3028 0129	1027047 Stator Stud	2
81	3028 0126	1063115 Stator, 115 V	1
	3028 0127	1063116 Stator, 230 V	1

SER-04 Reciprocating Breaking Saws

The latest in breaking saw technology. Electrically powered reciprocating saw for production breaking and general purpose use.

JARVIS®



Complete saw shown here.

- Light-weight — 19 pounds for ultimate flexibility.
- This electric saw is suitable for use on beef, hogs, sheep and veal.
- 1.9 hp motor. • Blade Speed: 4,100 strokes per minute.
- Overall Length: 20-1/2 inches • Weight: 19 pounds. • Meets national and international requirements for hygiene and safety.
- 1 phase, 50/60 Hz. • Common applications include cutting forequarters, shank bones, primal cuts, aitch bones, brisket opening, and splitting.
- Double insulated. • Smoother more comfortable operation. • Ultra low vibration. • TEFC motor.
- Order 200mm, 300mm, or 400mm blades and supports separately.

ITEM NO.	PRODUCT
3028 11371	115V/13A, Assembly Only
3028 15651	230V/6.5A, Assembly Only

NOTE: Order 200 mm, 300 mm, or 400 mm blades and supports separately. SEE BELOW.

CALL 800-456-5624 FOR PRICING AND INFORMATION

Blades and Supports for SER-04

End Cutting

ITEM NO.	PRODUCT	EACH
3028 15701	200 mm Blade and Support	\$643.73
3028 15711	200 mm Blade	153.96
3028 15721	200 mm Support	237.95
3028 15751	300 mm Blade and Support	1,267.42
3028 15771	300 mm Blade	240.00
3028 15791	300 mm Support	237.95
3028 15821	400 mm Blade and Support	552.12
3028 15831	400 mm Blade	115.46
3028 16101	400 mm Support	779.05

Heavy Cutting

ITEM NO.	PRODUCT	EACH
3028 16911	200 mm Blade and Support	\$337.66
3028 17031	200 mm Blade	109.93
3028 17041	200 mm Support	243.13
3028 17061	300 mm Blade and Support	301.62
3028 17281	300 mm Blade	111.30
3028 17311	300 mm Support	282.52
3028 17471	400 mm Blade and Support	301.61
3028 17481	400 mm Blade	119.49
3028 17511	400 mm Support	212.39



► PAGE 429

**USE WITH
PACKERS
KROMER™
INOXPRO®
BALANCER
ITEM NO. 1968 01501**

**WHEN YOU ARE READY TO UPGRADE TO JARVIS®
JUST GIVE US A CALL. WE ACCEPT COMPETITORS' EQUIPMENT ON
TRADE TOWARDS ANY NEW JARVIS® EQUIPMENT FOR YOUR PLANT.**

CALL 800-456-5624 FOR DETAILS

Buster Carcass Splitting Bandsaws

The world leader in splitting technology.

JARVIS®



Scan this QR code with your mobile device to see a Buster Bandsaw product video.

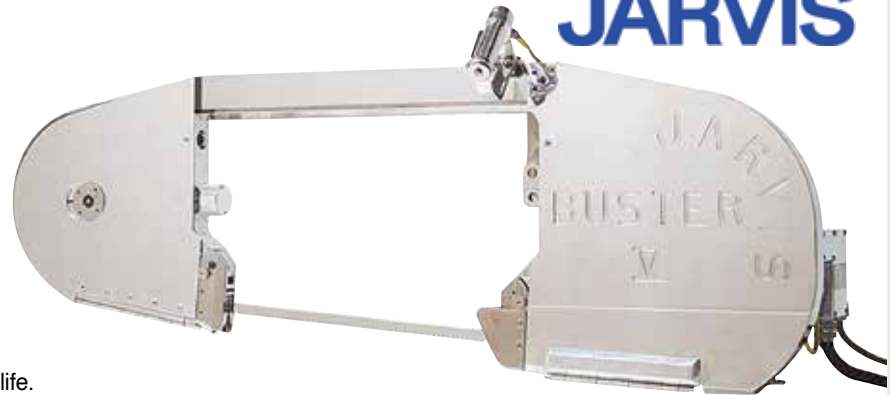

- Superior blade life.
- Electrically powered bandsaws for splitting cattle, bulls, oxen and pork.
- The largest Jarvis splitting saw; suited for the largest carcasses.
- Best possible hygiene — spoked wheels, flat surfaced housings and completely opening doors — for fast, easy, and complete cleaning.
- The drive system is oil bath lubricated for sustained trouble-free operation.
- Ultra-thin rail for unobstructed vision and dual rear handles for comfort.
- Anti-tie down controls and totally enclosed electric motor for operator safety.
- Meets national and international requirements for hygiene and safety.

JARVIS SERVICE TECHNICIANS ARE AVAILABLE TO PROVIDE FREE CUSTOMER SERVICE, INCLUDING EQUIPMENT INSTALLATION, SERVICE CALLS AND EMPLOYEE TRAINING. Call 800-456-5624 for details.

BUSTER SPLITTING BANDSAWS

BUSTER COMPARISON CHART

Which Buster is right for you?

ITEM NO.	DESCRIPTION	HP	CAPACITY PER HOUR	DISTANCE BETWEEN GUIDES	OVERALL LENGTH	DRIVE WHEEL SPEED (RPM)	WEIGHT
3028 1586	Buster IV Carcass Splitter	3.3	180 Head	17-3/4"	54"	620	190 lb
3028 1589	Buster V Carcass Splitter	3.3	180 Head	19-3/4"	57"	530	196 lb
3028 6060	Buster V Beef Loin Drop	3.3	900 Loins (450 Head)	22-3/4"	59"	530	187 lb
3028 6107	Buster VI Pork Carcass Splitter	3.0	200 Sow/400 Hogs	17-1/10"	51"	657	138 lb
3028 6147	Buster VI-ST Carcass Splitter Stretch	3.0	200 Sow/400 Hogs	23-1/10"	57-1/5"	657	140 lb
3028 6196	Buster IX Carcass Splitter	3.3	180 Head	19-3/4"	57"	530	218 lb
3028 6274	Buster X Carcass Splitter	3.3	450 Head	19-3/5"	57"	657	162 lb

Replacement Blades for Buster Bandsaw

Blade for the following saw:

ITEM NO.	PRODUCT	BLADE LENGTH	STANDARD BLADE	CUT TOOTH BLADE	JET BLADE
3028 1586	Buster IV Carcass Splitter . . .	119"	3028 0157 .	3028 3622	3028 3619
3028 1589	Buster V Carcass Splitter . . .	127"	3028 0281 .	3028 3338	3028 3620
3028 6060	Buster V Beef Loin Drop	133"	3028 0533 .	N/A	N/A
3028 6107	Buster VI Pork Carcass	112"	3028 0156 .	N/A	N/A
3028 6147	Buster VI-ST Carcass	123-7/10"	3028 2595 .	N/A	N/A
	Splitter Stretch				
3028 6196	Buster IX Carcass Splitter . . .	127"	3028 0281 .	3028 3338	3028 3620
3028 6274	Buster X Carcass Splitter . . .	112"	3028 0156 .	N/A	3028 36181

Recommended Balancers for Buster Bandsaw

▶ SEE PAGE 429

ITEM NO.	PRODUCT	RECOMMENDED BALANCER
3028 1586	Buster IV Carcass Splitter	1968 01301
3028 1589	Buster V Carcass Splitter	1968 01301
3028 6060	Buster V Beef Loin Drop	1968 01301
3028 6107	Buster VI Pork Carcass Splitter	1968 01291
3028 6147	Buster VI-ST Carcass Splitter Stretch . . .	1968 01291
3028 6196	Buster IX Carcass Splitter	1968 01311
3028 6274	Buster X Carcass Splitter	1968 01291

We are a full-line stocking distributor for Jarvis® replacement parts and blades for all Jarvis® tools.

IDFI SWITCH ORDERING IDENTIFICATION GUIDE

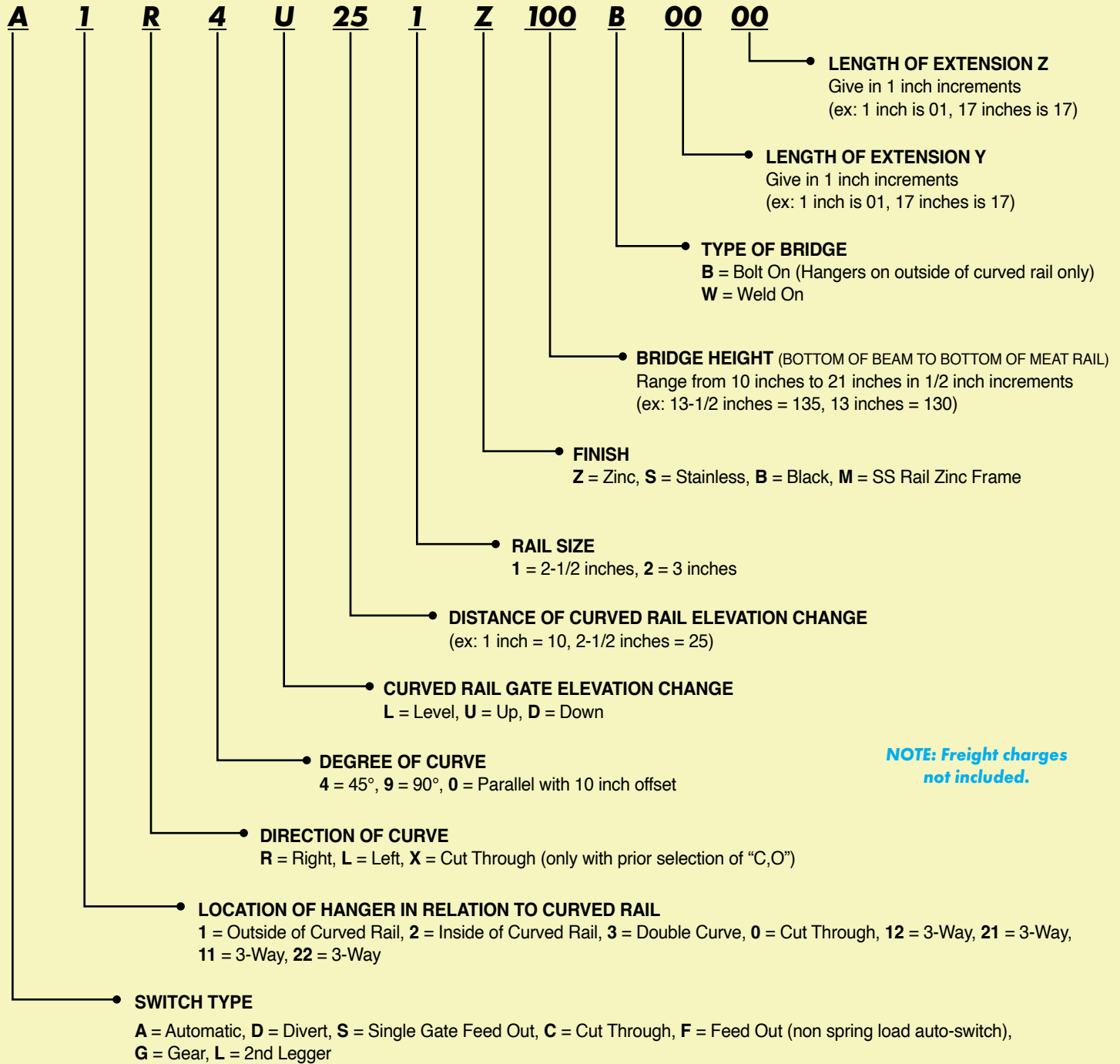

NOTE: Freight charges not included.

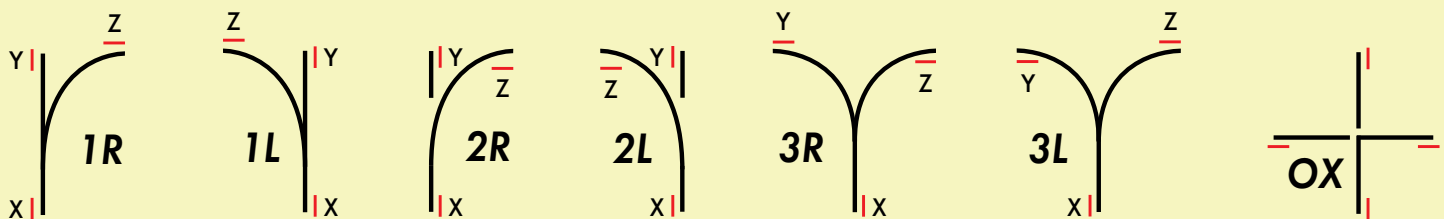

HERCULES™ Rail Switches



SPECIAL
ORDER
ITEM

RAIL SWITCHES

Automatic Switches: 2,000/3,000 pound rating*

- Replacement Pin, Bushing and Shoulder Nut.
 - No more attempting to repair broken or bent bolts to correct angle.
 - Replacement Pin design assures proper angle and position every time.
 - Bushing and nut set spacing eliminates over tightening bolt issues.
 - Pin replacement, easy as replacing a bolt.
 - Pin and Bushing combination increases strength.
- Switching mechanism has fewer parts than the competition.
- Switching uses easier up and down motion to change gates — eliminates side-to-side motion to change gates.
- Heavy guards protect linkages against trolley damage.
- Stainless steel turnbuckle design on adjusting arm.

Divert Switches: 4,000 pound rating (Air or Hydraulic Options)

- Stronger one piece Cylinder Mounting Arm Bracket.
- New cleaner spring location.
- Stainless steel cylinders air or hydraulic.
- Gate design improves weight transfer throughout the entire switch.

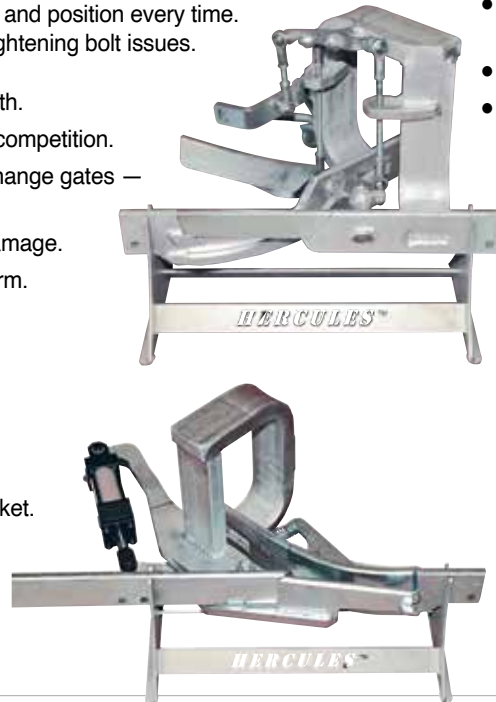

Gear Switches: 2,000/3,000 pound rating*

- Offers lower gate travel path height reducing chain interference issues (patent pending design).
- Heavy-duty trolley stop (patent pending design).
- Heavier gear design.



NOTE: All switches are patent-pending designs.

*Automatic and Gear Switches carry a 2,000 pound rating when hung with hangers. Rating can increase to 3,000 pounds when welded off to a beam.

Rails:

- Rails are water jet cut using T1 steel which increases strength and improves wear resistance.
- Water jet cutting allows an increase in the amount of material under the gate pocket as well as accurate duplication of parts.
- HERCULES™ = 1-3/4 inches – Industry Standard = 1-1/4 inches.
- Heavier Gates – increased gate dimension due to cutting the parts out of plate steel instead of using standard 2-1/2" meat rail.
- HERCULES™ Gate 1-1/2 inches.
- Industry Standard Gate 1-1/4 inches.

Bridge/Uprights:

- 1 inch x 2-1/2 inch upright dimension.
- Uprights clock into rail for accurate line up and stronger welds — allowing weld on both sides of rail. The industry standard design uses a face weld on one side only.
- Bolt on bridge design matches up for true placement.
 - Wider bolt pattern increases strength.
 - Lower flange design places bolts below beam.
 - Flange design gives clean welding surface.

Parts:

- Parts repeatability achieved by water jet cutting, laser cutting and CNC machining.
- Easy-to-follow parts sheets only require basic switch information to order correct replacement parts.
- Off the shelf parts interchangeability means faster turn around and less down time.
- Precision parts require less time to change out parts and complete repairs done to units hanging in place.
- HERCULES™ Switches are made one design per style only, minimizing confusion and ordering errors.

Quoting and Ordering:

- Switch part number explanation sheet gives step-by-step guidelines to get all the necessary information when ordering switches.
- Ordering Identification Guide provides pictures to better identify switch style, type and dimensions.

Whole Units:

- Faster delivery times.
- HERCULES™ Switches are made to industry standard dimensions allowing use of existing hangers when replacing competitors switches.

FOR INFORMATION ON RAILS AND SWITCHES

Chuck Bildstein: charles.bildstein@bunzlusa.com or call 319-573-6121.

Ryan Malone: ryan.malone@bunzlusa.com or call 816-820-7768.

VGK Oil-Free Rail Systems

The first and only oil-free trolley on the market.

Old-fashioned cast-iron trolleys and carbon steel rail cause black specks/rail dust that require oil, hazardous chemicals and wasteful, labor-intensive trimming. Most cast-iron trolley wheels wear out within months, while VGK wheels last for years and are cleaned with simple soap and water.

Additional benefits to the VGK Oil-Free Stainless Steel Trolley:

- No metal-to-metal contact wheel to rail. • Eliminates oil costs.
- Eliminates trimming labor and waste due to trolley contamination.
- Eliminates black specks, rail dust, oil drips. • Lasts years instead of months.
- Eliminates caustic cleaners used to derust trolleys, a hazardous waste.
- Consistent tare weight. • Meets USDA, FDA and FSIS guidelines.
- Calculated return on investment — 1 year ROI.
- Reliable carrier of information technology.



VGK Rail Trolley with hook.



VGK stainless radius rail.



VGK Rail Trolley with gambrel.



Patented wheel design requires NO OIL!

TRIM YOUR COSTS CLEAN AND GREEN



How long do your cast iron wheels last?

This VGK wheel has been in continuous use for 12 YEARS and is still rolling strong!

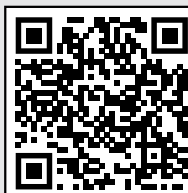

Scan this QR Code with your mobile device to watch a video about VGK Trolley Systems.

CALL 800-456-5624 FOR PRICING AND INFORMATION

Overhead Rail Trolley Replacement Parts

Axle

ITEM NO.	PRODUCT	F.O.B. FACTORY EACH
2321 8014	Black, 1/2" x 2-1/2"	\$2.15
2321 8026	SS, 1/2" x 2-1/2"	5.15



Swivel

ITEM NO.	PRODUCT	EACH
2321 7912	1/2" Swivel	\$3.25
2321 7910	SS, 1/2" Swivel	8.25



Wheels Cast Iron Construction

ITEM NO.	PRODUCT	EACH
2321 7821	Black, 4-3/4"	\$15.55
2321 7811	Black, 3.9"	12.76
2321 7812	Galvanized, 4-3/4"	20.05
2321 7810	Galvanized, 3.9"	14.73



HOW TO DETERMINE THE SIZE TROLLEY YOU NEED

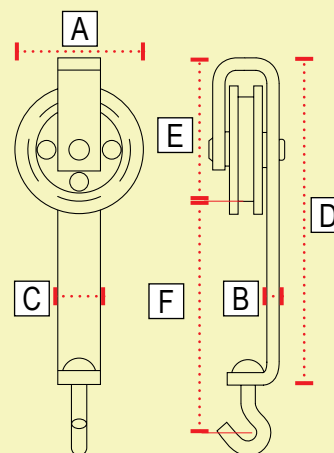

Overhead Rail Trolleys

- Smooth rolling trolley wheels of quality cast iron, galvanized or stainless steel.
- Precision cast groove fits 3/8-inch or 1/2 inch-tracking. • Wheels will not climb curves or switches.
- Trolleys are supplied with swivels. • Standard wheel is plain bore with oil hole.
- Other options available include graphite bearings, oilite bearings, roller bearings, and zerk grease fittings.



Black Steel Finish — Cast Iron Construction

ITEM NO.	WHEEL DIA.		FRAME SIZE		FRAME LENGTH	TOP OF RAIL TO TOP OF BAR	TOP OF RAIL TO CENTER OF SWIVEL	F.O.B. FACTORY	
	A	B C	D	E	F	WEIGHT	EACH		
2321 7214	3-7/8"	3/8" x 1-1/4"	10-1/4"	4-1/2"	7-1/2"	4.40 lb	\$23.55		
2321 7216	3-7/8"	3/8" x 1-1/2"	10-1/4"	4-1/2"	7-1/2"	4.83 lb	23.55		
2321 7316	4-3/4"	3/8" x 1-1/2"	11-1/2"	5-1/4"	8"	5.89 lb	27.62		
2321 7318	4-3/4"	3/8" x 1-3/4"	11-1/2"	5-1/4"	8"	6.30 lb	35.83		
2321 7321	4-3/4"	3/8" x 1-3/4"	11-1/2"	5-1/4"	8"	6.30 lb	34.25		

Item # 2321 7321 is HEAT TREATED for use with heavier products such as beef.

Galvanized Steel Finish — Cast Iron Construction

ITEM NO.	WHEEL DIA.		FRAME SIZE		FRAME LENGTH	TOP OF RAIL TO TOP OF BAR	TOP OF RAIL TO CENTER OF SWIVEL	F.O.B. FACTORY	
	A	B C	D	E	F	WEIGHT	EACH		
2321 7212	3-7/8"	3/8" x 1-1/4"	10-1/4"	4-1/2"	7-1/2"	4.50 lb	\$34.35		
2321 7215	3-7/8"	3/8" x 1-1/2"	10-1/4"	4-1/2"	7-1/2"	4.93 lb	34.35		
2321 7315	4-3/4"	3/8" x 1-1/2"	11-1/2"	5-1/4"	8"	5.99 lb	34.25		
2321 7317	4-3/4"	3/8" x 1-3/4"	11-1/2"	5-1/4"	8"	6.40 lb	45.87		

Stainless Steel Finish

ITEM NO.	WHEEL DIA.		FRAME SIZE		FRAME LENGTH	TOP OF RAIL TO TOP OF BAR	TOP OF RAIL TO CENTER OF SWIVEL	F.O.B. FACTORY	
	A	B C	D	E	F	WEIGHT	EACH		
2321 7115	3-7/8"	3/8" x 1-1/2"	10-1/4"	4-1/2"	7-1/2"	4.14 lb	\$106.89		
2321 7124	4-3/4"	3/8" x 1-1/2"	11-1/2"	5-1/4"	8"	5.11 lb	100.81		



NOTE: When ordering, please specify if you would like hooks attached.

Stainless Steel Double Trolley with Roller Bearing Wheel

- Stainless steel 4 inch diameter roller bearing wheel for ease of rolling heavy loads.
- Wheels are heat treated to a high hardness for long wear.
- Rollers and balls are held separate in a cage to reduce friction.
- Suitable for brine chill installations.
- Wheel flanges are smooth and rounded to prevent track climbing.
- Frames made of solid 18-8 Type 304 stainless steel.
- Electropolished to a bright, smooth finish.



ITEM NO.	WHEEL DIA.		FRAME SIZE		FRAME LENGTH	TOP OF RAIL TO TOP OF BAR	TOP OF RAIL TO CENTER OF SWIVEL	WEIGHT	LOAD CAPACITY	SWIVEL SIZE	EACH
	A	B C	D	E	F						
2321 7139	4"	3/8" x 1-1/2"	11-1/2"	5-1/8"	8-3/4"	15.63 lb	1,200 lb	5/8"	\$380.68		
2321 7141	4"	3/8" x 2"	11-1/2"	5-1/8"	8-3/4"	17.00 lb	1,800 lb	3/4"	493.08		

Poultry Shackles

- A. High bar stainless steel shackle poly block with nylon sleeve and washers.
- B. Dapec shackle with stainless steel body and poly block metal collar.

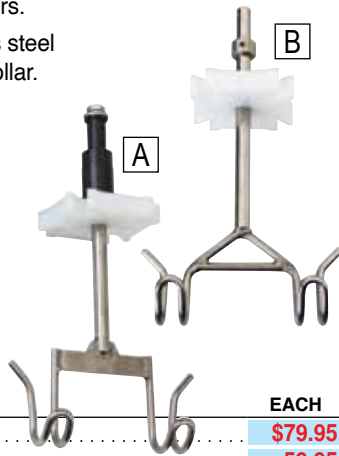

ITEM NO.	PRODUCT	EACH
0891 24061	A. High Bar	\$79.95
0891 06131	B. Dapec Shackle	59.95

Stainless Steel Fresh Meat Trees

- Sturdy type 304 stainless steel rod construction, 1/2 inch diameter.
- Hooks are 3/8 inch diameter, securely welded, ground and polished to a smooth finish.
- Hooks have sharp points and long taper for easy penetration.
- Available in both in-line and staggered hook arrangement.
- Electropolished to a bright, smooth finish.

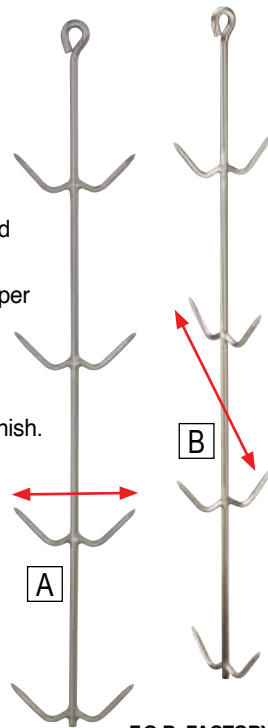

NOTE: Additional sizes are available. Call for more information.

A. In-Line

ITEM NO.	PRODUCT	SIZE	WEIGHT	EACH
2321 34101	4 Hooks	22"	1.9 lb	\$46.95
2321 34111	6 Hooks	36"	2.9 lb	58.12
2321 34121	8 Hooks	42"	3-1/2 lb	64.02
2321 34141	10 Hooks	45"	3.9 lb	73.78
2321 34151	12 Hooks	48"	4-2/5 lb	100.74

B. Staggered

ITEM NO.	PRODUCT	SIZE	WEIGHT	EACH
2321 34501	4 Hooks	22"	1.9 lb	\$46.95
2321 34511	6 Hooks	36"	2.9 lb	58.12
2321 34521	8 Hooks	42"	3-1/2 lb	67.51
2321 34531	10 Hooks	45"	3.9 lb	73.78
2321 34541	12 Hooks	48"	4-2/5 lb	100.74

Stainless Steel Trolley Hooks



NOTE: Additional sizes are available. CALL FOR MORE INFORMATION.

ITEM NO.	PRODUCT	SIZE	CAPACITY	WEIGHT	EACH
2321 3906	A. Single Hook	.1/2" x 6"	700 lb.	0.62 lb	\$9.11
2321 4007	B. Single Hook	.5/8" x 7"	2,000 lb	1.10 lb	14.10
2321 39241	C. Single Hook	.1/2" x 24"	700 lb.	1.62 lb	21.93
2321 41121	D. Double Sheep Hook	.1/2" x 6"	700 lb.	1.03 lb	18.21
2321 41101	Double Sheep Hook	.3/8" x 6"	300 lb.	0.59 lb	15.95
2321 42121	Double Hook	.3/8" x 12"	300 lb.	0.68 lb	27.45
2321 42181	Double Hook	.3/8" x 18"	300 lb.	0.86 lb	29.45
2321 42241	Double Hook	.3/8" x 24"	300 lb.	1.05 lb	34.05
2321 42361	Double Hook	.3/8" x 36"	300 lb.	1.43 lb	40.55
2321 44121	Double Hook	.1/2" x 12"	700 lb.	1.20 lb	27.45
2321 44181	Double Hook	.1/2" x 18"	700 lb.	1.54 lb	31.55
2321 44241	Double Hook	.1/2" x 24"	700 lb.	1.87 lb	35.15
2321 44361	Double Hook	.1/2" x 36"	700 lb.	2.54 lb	39.99

Stainless Steel Hog Gambrels

- Made of solid 18-8 Type 304 stainless steel.
- Electropolished to a bright, smooth finish.
- Can be supplied with or without trolley rollers attached.
- A. Has welded center reinforcement.
- B. Flat bar has loop made of solid stainless steel.
- Hog gambrels can be made to meet your specifications.

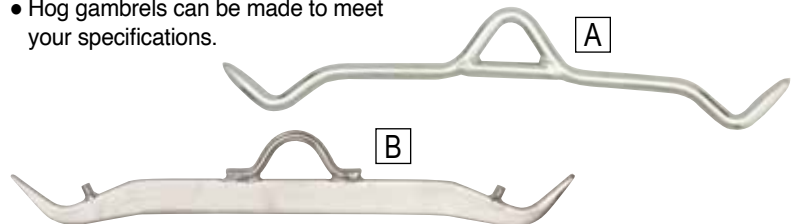

ITEM NO.	PRODUCT	WEIGHT	F.O.B. FACTORY EACH
2321 4710	A. 5/8" x 21-1/2" Reinforced Center	2.39 lb	\$36.50
2321 4711	3/4" x 21-1/2" Reinforced Center	3.41 lb	43.38
2321 4713	B. 5/16" x 1-1/2" x 21-1/2" Flat Bar	3-2/5 lb	44.85

Custom Flat Steel Bar Gambrels

- One piece solid stainless steel construction with rolled edges.
- True sanitary design, custom manufactured to your specifications with exact verified weight.



Call for details and to place your order.

Weasand Clips

- Constructed of FDA/EU-approved material.
- Designed for quick and easy use.
- Available by the case or in a cartridge.
- Clip breaks into small inert particles through most rendering systems.
- Applied properly, there is no chance of ingesta leakage or clip slippage.
- Use of the cartridge with a dispenser eliminates clip cross contamination, speeds up access for line operator and reduces dropped and wasted clips.

1-Inch Lamb Weasand Clips

- Effective across a variety of species including calves, veal, goats, and venison.
- Cartridge dispensers help eliminate cross contamination.
- 25 clips per cartridge.



ITEM NO.	QUANTITY	CASE
5815 0285	Bulk Pack, 6,000/Case	\$216.33
5815 0004	25/Cartridge, 4,000/Case	158.26

2-Inch Beef Weasand Clips

- Available in white or blue.

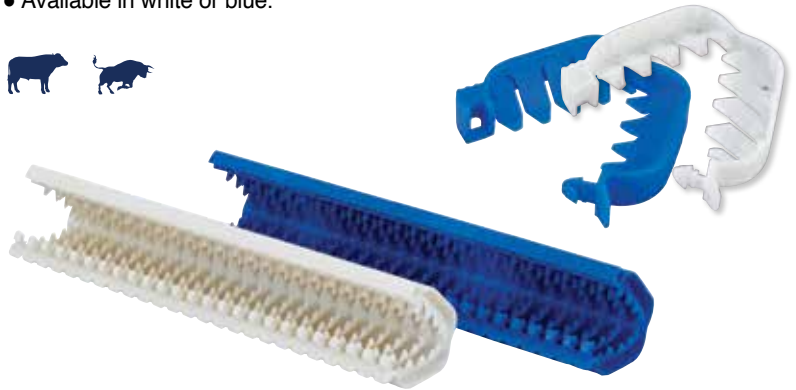

ITEM NO.	COLOR	QUANTITY	CASE
5815 5001	White	Bulk Pack, 2,000/Case	\$141.39
5815 5003	Blue	Bulk Pack, 2,000/Case	165.44
5815 5002	White	25/Cartridge, 2,000/Case	131.70
5815 5004	Blue	25/Cartridge, 2,000/Case	166.92

Weasand Rod

- Constructed of sanitary #304 stainless steel.
- 5 inches wide x 1 inch diameter welded handle.
- 24-inch long rod is 5/16 inch in diameter.

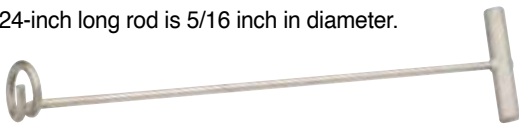

ITEM NO.	PRODUCT	EACH
2321 8055	Weasand Rod	\$66.95

Beef Throat Plug

- Reduces the risk of ingesta leakage before weasand clip is applied.
- Plug "fingers" securely hold the plug in place.
- Plastic plug can be removed and reused.

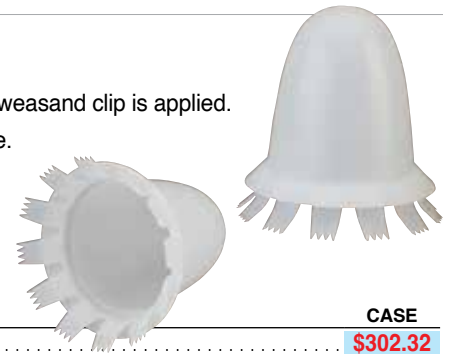

▶ 1,200 PER CASE.

ITEM NO.	PRODUCT	CASE
5815 1004	Beef Throat Plug	\$302.32



Weasand/Bung Ring Expander

- Used for expanding and installing weasand and bung rings.
- Light-weight and flexible for optimum operator comfort.
- All stainless construction for maximum hygiene.
- Weasand rings are designed for sealing the esophagus of slaughtered beef.
- Bung rings are designed for sealing the rectum of slaughtered beef.

JARVIS®

MADE IN USA

ITEM NO.	PRODUCT	EACH
3028 0139	Weasand/Bung Ring Pliers	\$49.32
3028 3251	Weasand Rings, 5 mm ID (10,000 Rings/Bag)	213.06
3028 0140	Bung Rings, 12 mm ID (3,000 Rings/Bag)	187.45

FREE SHIPPING* FREE GROUND SHIPPING
when you place an order for \$500 or more from THIS BUYERS GUIDE!

*FREE SHIPPING does NOT include UPS Next Day Air, UPS 2nd Day or UPS 3rd Day Select. Certain items may not qualify. This offer is good only on orders shipped UPS Ground in the 48 contiguous states. Based on dimensional weight, we will determine the most efficient means of shipment, either UPS or LTL. Products may ship by truckline.



Processing Eyelet Tags

▶ 1,000 PER BOX - 10 BOXES PER CASE.

ITEM NO.	COLOR	SIZE	BOX
4494 14925	Manila	.3-1/4" x 1-5/8", Size 2	\$23.05
4494 14955	Manila	.4-3/4" x 2-3/8", Size 5	27.30
4765 13895	Green	.3-3/4" x 1-7/8", Size 3	33.19
4765 13435	Red	.3-3/4" x 1-7/8", Size 3	33.19
4765 00785	Blue	.3-3/4" x 1-7/8", Size 3	33.19
4765 13235	Yellow	.3-3/4" x 1-7/8", Size 3	33.19

NOTE: Other colors and sizes are available. Call for more information.

Water-Resistant Curing Tags

- Dimensions: 1-2/5 inches x 2-3/4 inches.



▶ 1,000 PER BOX - 10 BOXES PER CASE.

ITEM NO.	COLOR	BOX
4494 11915	A. White Curing Tag, No #s.	\$61.71
4494 31915	B. White Curing Tag, #000-999.	111.89

A. 2-Part Head Tag

- Numbered 000 - 999.
- Perforated.
- 1-1/4 inches x 1-1/4 inches.

▶ 2,000 PER BOX - 10 BOXES PER CASE.

ITEM NO.	PRODUCT	BOX
4765 32025	A. 2-Part Head Tag, #000 to 999	\$55.97

B. 3-Part Head Tag

- Numbered 000 - 999.
- Perforated.
- 1-2/5 inches x 2-3/4 inches.

▶ 1,000 PER BOX - 5 BOXES PER CASE.

ITEM NO.	PRODUCT	BOX
4494 14105	B. 3-Part Head Tag, #000 to 999	\$85.73

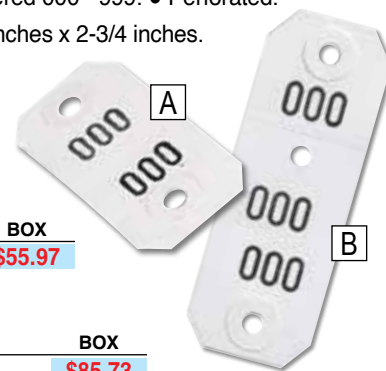

4-Part Hot Carcass Tags

- Space to list: Date, Lot No., Tag No. and Hot Weight.
- Adheres to hot carcass without deadlocks or other attachments.
- May be used for Federal Inspection.
- 4-part, perforated.



▶ 1,000 PER BOX - 25 BOXES PER CASE.

ITEM NO.	PRODUCT	SIZE	BOX
4765 32095	4-Part Hot Carcass Tags	.2.1" x 4-1/4"	\$56.95

Deadlock Tag Fasteners

- 17-gauge tinned wire sharply pointed on each end.



NOTE: Tag not included.

▶ 4 BOXES PER CASE.

ITEM NO.	PRODUCT	QUANTITY	BOX
3489 31855	Fasteners	1,000/Box	\$21.25
3489 1202	50 lb Bulk Box	Approx. 22,000 Pieces	248.59

Laser 3[®] Tagging System

- Stainless steel ejector needle can be easily replaced in less than two minutes.
- Low-maintenance, easily repaired in the field.



A safety cover provided to snap over the injector needle when not in use.



Laser 3[®] Fasteners

- 25 fasteners per clip.

▶ 1,000 FASTENERS PER PACKAGE - 50 PACKAGES PER CASE.

ITEM NO.	PRODUCT	EACH	PACKAGE
7735 4647	Tag Gun	\$72.90	\$12.30
7735 4665	Repl. Needles, Heavy-Duty (4/pack)	43.67	12.30
7735 46505	Aqua Blue		12.30
7735 46535	Green		12.30
7735 46515	Yellow		12.30

All-Weather® PaintStik®

- Use on wet or dry animals in holding pen.
- Non-toxic paint is safe for all types of livestock.
- Made in the USA.



▶ 12 PER BOX.

ITEM NO.	PRODUCT	BOX
1611 10115	Yellow	\$25.47
1611 10125	Pink	25.47
1611 10225	Red	25.47
1611 10265	Green	25.47
1611 10255	Blue	25.47
1611 10245	Orange	25.47

All-Weather® Meat Markers

The ONLY marker registered by NSF for use in USDA inspected meat packing plants!



- NEW improved formula gives twice the output per stick with greater strength.
- For marking directly on animal carcasses and other meat parts.
- Wrapped in convenient paper holder.
- 33% larger than other brands.
- Made in the USA.

Marker can be used with optional marker holder.



▶ 12 PER BOX.

ITEM NO.	PRODUCT	BOX
1611 21025	Purple Marker	\$60.01
1611 53001	Optional Marker Holder	25.15

Self-Inking Stencil Brush

- 2-inch long bristles.
- 1-1/4 inch diameter ink reservoir barrel.



ITEM NO.	PRODUCT	EACH
3599 03221	Stencil Brush	\$78.72
3599 00011	1-qt. Black Ink	89.95

Livestock ID Tag Cement

- Adheres to animal hair in both hot and cold temps.



ITEM NO.	PRODUCT	EACH
3981 25181	6 oz. Tube	\$6.55

Stainless Steel Trigger Action Market Handsaws

- Stainless steel frame.
- Black ABS plastic handle.
- Available in two sizes.

NOTE: Handsaws includes 12 FREE Blades!

ITEM NO.	PRODUCT	EACH
3363 18201	20" Handsaw w/12 FREE Blades	\$82.34
3363 0825	25" Handsaw w/12 FREE Blades	102.36



Stainless Steel Trigger Action Handsaws

- Trigger blade tightener.
- Stainless steel frame.
- Ivory ABS plastic handle.

ITEM NO.	PRODUCT	EACH
6466 9018	20" Market Saw	\$92.80
6466 9011	25" Market Saw	92.80
3363 0020	Replacement Blades, 20" (1 Dozen)	41.81
3363 0025	Replacement Blades, 25" (1 Dozen)	50.99
3363 0027	Replacement Blades, 27" (1 Dozen)	44.06
6466 0013	Replacement Handle	14.80
6466 0015	Replacement Nut (Need 3 per Handle)	0.60
6466 0016	Replacement Screws (Need 3 per Handle)	0.60

Replacement Blades for Packer Saws and Splitting Saw

ITEM NO.	PRODUCT	DOZEN
3363 0020	Replacement Blades, 20"	\$41.81
3363 0019	Replacement Blades, 19"	39.68
3363 0030	Replacement Blades, 30" Splitting Saw	45.12



NOTE: Buy replacement blades by the dozen.

Hog Toenail Puller

- 1 inch between stainless steel points.
- Stainless steel T-handle.
- Overall length: 6 inches.



ITEM NO.	PRODUCT	EACH
2321 8054	Toenail Puller	\$44.95

Spinal Cord Remover

- Constructed of stainless steel to resist rusting.
- Pork blade length: 1 inch.
- Beef blade length: 1-1/2 inches.
- Overall length: 7-1/2 inches.
- Machine washable.
- Heavy-duty plastic handle.



ITEM NO.	PRODUCT	EACH
6466 0600	Spinal Cord Remover	\$30.26
6466 0601	Beef Replacement Blade	3.45
6466 0602	Pork Replacement Blade	3.55

Magnetic Shroud Pin

- Overall length: 4-3/4 inches.
- Stainless steel.



▶ 1,000 PER CASE.

ITEM NO.	PRODUCT	CASE
2321 2112	Shroud Pin	\$669.11

Rib Pulling Handle and Blades

- Molded plastic handle.
- 6-1/4 inch stainless steel arm.
- Blades are easily replaced.

ITEM NO.	PRODUCT	EACH
A657 34101	A. Rib Pulling Handle	\$67.21

▶ 5 PER PACK.

ITEM NO.	PRODUCT	PACK
A657 14121	B. 12 mm Blade	\$23.90
A657 14145	14 mm Blade	23.90
A657 14165	16 mm Blade	23.90
A657 14185	18 mm Blade	23.90
A657 14205	20 mm Blade	23.90
A657 14225	22 mm Blade	23.90
A657 14255	25 mm Blade	23.90

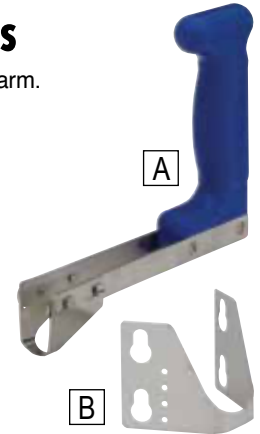

NOTE: Blades and handle are sold separately.

Poultry Lung Scraper

- Overall length: 12-1/2 inches.
- Blade: 1 inch x 1-3/4 inches.
- Stainless steel with plastic handle.



ITEM NO.	PRODUCT	EACH
2990 10561	Lung Scraper	\$99.10

Hog Polishing Whips

- Constructed of heavy-duty, durable plastic for long life and optimum performance.
- 0.398-inch bush hole.
- Designed for today's modern hog processing lines.



ITEM NO.	PRODUCT	EACH
3939 00041	Natural Color	\$7.66
3939 00021	Brown Color	7.74

Old Baldy® Hog Scald

- Effective on tough bristles, reduces scraping labor.
- Contains no inert ingredients or fillers.
- Highly concentrated, economical to use.
- Very effective in hard water, contains a powerful cleaning agent and water softener.
- Keeps grease in suspension, no scum, film or slime is deposited on the last hogs in the scalding vat.
- Complete instructions with every order.



ITEM NO.	PRODUCT	EACH
3032 9010	10-lb Hog Scald	\$32.95

Bell Hog Scraper

- 4-3/4-inch bell shaped carbon steel blade.
- Level ground edge.
- White poly handle.



ITEM NO.	PRODUCT	EACH
3955 01101	Bell Scraper	\$39.64

Hog Hide Shaver

- Pistol-grip style poly handle.
- Replaceable skinner blades.



ITEM NO.	PRODUCT	EACH
0891 00021	Hog Hide Shaver Handle	\$69.95
5880 3062	Repl. Blades (100/pack)	89.95



Hog Scraper Paddles

- Case hardened steel knives.
- Durable rubber cover is easy to clean.
- Bias cut fabric stretches to maintain contact between knives and carcass.
- Fabric reinforcement of compression section ensures durability for the life of the paddle.

NOTE: Attachment hardware sold separately.

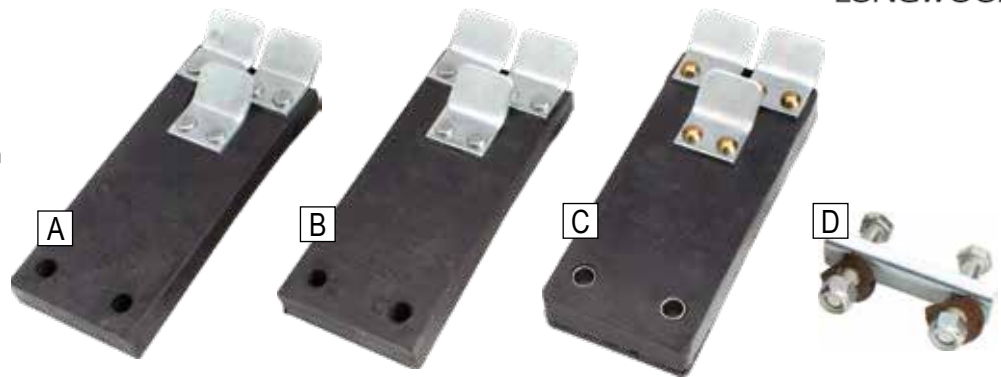

A. 5-Star Paddles

- Rubber wedge for added stiffness — paddles last 4 to 5 times longer than conventional types.
- Substantially reduce machine downtime and replacement costs.
- 1/2-inch mounting holes, 2-1/2-inch mounting hole distance.

ITEM NO.	PRODUCT	SIZE	EACH
3939 0001	5-Star Paddle, 3 Cleat	4" x 9"	\$68.02

B. 7-Star Paddles

- Heavy 5-ply fabric wedge increases stiffness and durability — paddles last up to 10 times longer than conventional types.
- 1/2-inch mounting holes, 2-1/2-inch mounting hole distance.
- Handle hogs up to 550 pounds.
- Work fast and clean, even during “hard hair” season.

ITEM NO.	PRODUCT	SIZE	EACH
3939 00171	7-Star Paddle, 3 Cleat	4" x 9"	\$66.69
3939 9015	7-Star Paddle, 5 Cleat	4" x 9"	98.03

C. PremiumStar® Paddles

Research and in-plant testing have proven that this is the paddle to use in high-impact areas for the most punishing of applications.

- Constructed of super-strong material compound to improve performance and provide longer life and lower maintenance.
- Paddles retain their operating stiffness — won't bow after a few days.
- Includes steel bushings.
- 1/2-inch mounting holes, 2.44-inch mounting hole distance.

ITEM NO.	PRODUCT	SIZE	EACH
3939 10031	PremiumStar® Paddle, 3 Cleat	4" x 9"	\$64.63

D. Attachment Hardware

- For use with all paddles listed above. (Not for use with backers.)
- Contains hardware to attach one paddle to de-hairing machine.
- Set contains: 1 bolt plate, 2 cap screws, 2 cut washers and 2 elastic stop nuts.

ITEM NO.	PRODUCT	EACH
3939 0016	Attachment Hardware for 4" x 9" Paddles	\$18.07

Chicken and Turkey Diaphragms

For Automatic Deboning Machines

- External diameter: 9 cm.
- Internal diameters: 12 cm to 32 cm.
- Thickness: 1 cm.



A	B	C	D	E	F	QTY/CASE
90 mm	10 mm	10 mm	60 mm	15 mm	5 mm	300
3.54 in.	0.39 in.	0.39 in.	2.36 in.	0.59 in.	0.19 in.	

SIZE MEASUREMENTS (MM/INCH)

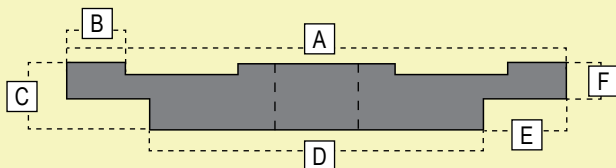

DUROMETER: COLOR AND HARDNESS

SOFTER ←		→ HARDER		
GRAY 50	YELLOW 55	GREEN 60	RED 65	BROWN 70
BLACK 50, 55, 60, 65, 70, 75				



Poultry Picking Fingers

Suitable for plucking all poultry types.

- Maximum flexibility and excellent picking performance without damaging skin.
- Available models: AM, AM112, AMC, AMN, J260, L, MG, MG160, PL2, RL2, RL3, RL10, RL92.
- Various round, oval, flat, specialty shapes and colors available • Compatible with: Meyn, Stork, Bayle, Systemate, Linco and others.



PRODUCT	ITEM	DESCRIPTION
	AM	Flat Finger, ribbed
	AM112	Flat Finger, ribbed
	AMC	Flat Finger, ribbed
	AMN	Oval Finger, ribbed
	J260	Long Round Finger
	L	Round Finger, ribbed
	MG	Round Finger, ribbed
	MG160	Round Finger, ribbed
	PL2	Round Finger, patterned
	RL2	Round Finger, ribbed
	RL3	Round Finger, patterned
	RL10	Round Finger, ribbed
	RL92	Round Finger, ribbed

SIZE MEASUREMENTS (MM/INCH)

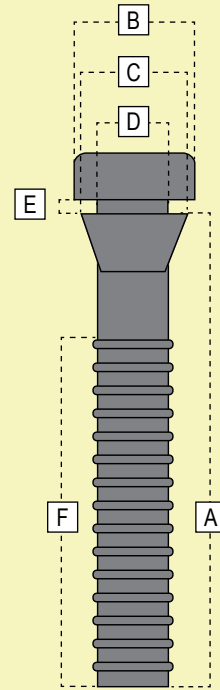

DUROMETER: COLOR AND HARDNESS



ITEM	DESCRIPTION	A	B	C	D	E	F	HARDNESS	QTY/CASE
AM	Flat Finger, ribbed	133 mm 5.24 in.	36 mm 1.42 in.	28.5 mm 1.12 in.	24 mm 0.94 in.	3.5 mm 0.138 in.	90 mm 3.54 in.	All Available	250
AM112	Flat Finger, ribbed	112 mm 4.41 in.	36 mm 1.41 in.	33 mm 1.29 in.	27 mm 1.06 in.	3 mm 0.118 in.	75 mm 2.95 in.	All Available	300
AMC	Flat Finger, ribbed	165 mm 6.49 in.	36 mm 1.41 in.	33 mm 1.29 in.	27 mm 1.06 in.	2 mm 0.078 in.	120 mm 4.72 in.	All Available	200
AMN	Oval Finger, ribbed	125 mm 4.92 in.	34 mm 1.34 in.	30 mm 1.18 in.	25 mm 0.985 in.	3 mm 0.118 in.	83 mm 3.26 in.	All Available	250
J260	Long Round Finger	250 mm 10.24 in.	27 mm 1.07 in.	22 mm 0.868 in.	18 mm 0.66 in.	2.5 mm 0.078 in.	220 mm 8.66 in.	All Available	250
L	Round Finger, ribbed	125 mm 4.92 in.	27 mm 1.07 in.	23.5 mm 0.92 in.	20 mm 0.78 in.	6 mm 0.236 in.	89 mm 3.5 in.	All Available	400
MG	Round Finger, ribbed	130 mm 5.11 in.	37 mm 1.45 in.	30 mm 1.18 in.	25 mm 0.985 in.	3.5 mm 0.14 in.	86 mm 3.38 in.	All Available	250
MG160	Round Finger, ribbed	160 mm 6.29 in.	37 mm 1.45 in.	30 mm 1.18 in.	25 mm 0.985 in.	3 mm 0.118 in.	115 mm 4.52 in.	All Available	250
PL2	Round Finger, patterned	80 mm 3.15 in.	28.2 mm 1.11 in.	23.5 mm 0.92 in.	19.5 mm 0.77 in.	2.2 mm 0.086 in.	55.5 mm 2.196 in.	All Available	500
RL2	Round Finger, ribbed	85 mm 3.34 in.	29 mm 1.14 in.	26 mm 1.023 in.	22 mm 0.87 in.	3 mm 0.118 in.	55 mm 2.165 in.	All Available	500
RL3	Round Finger, patterned	80 mm 3.15 in.	28 mm 1.10 in.	24 mm 0.94 in.	20 mm 0.79 in.	2 mm 0.078 in.	50 mm 1.97 in.	All Available	500
RL10	Round Finger, ribbed	87 mm 3.425 in.	30 mm 1.18 in.	25 mm 1.023 in.	20.5 mm 0.82 in.	7.5 mm 0.29 in.	55 mm 2.165 in.	All Available	500
RL92	Round Finger, ribbed	92 mm 3.62 in.	30 mm 1.18 in.	24.5 mm 0.96 in.	21 mm 0.827 in.	2 mm 0.078 in.	54 mm 2.12 in.	All Available	500

PLC-92 and PLC-160 Picking Finger Machine

Cuts and pulls all types of picking fingers from 80 mm to 140 mm.

- Length: 345 mm.
- Height: 235 mm.
- Weight: 7 pounds.
- Operating Pressure: 7-bar.



Picking Finger Machines available. Easy to use for both installation and removal of picking fingers.

Picking machines, puller wheels and additional Plumatech products available. **CALL 800-456-5624.**

Impianti Drive Wheel

Fits Impianti counter rotational picker machine.

- Outside Diameter: 18.3 inches.
- Inside Diameter: 13.58 inches.
- Tooth Pattern: 36 teeth.



ITEM NO.	MFR. NO.	EACH
6968 00031	RP-1000	\$68.97

Poly-Nylon Needlepoint Tattoo Inserts



F.O.B. FACTORY
▶ 10 PER CASE.

Letter Inserts

ITEM NO.	PRODUCT	ITEM NO.	PRODUCT	EACH
6945 22001	"A" Insert	6945 22131	"N" Insert	\$6.77
6945 22011	"B" Insert	6945 22141	"O" Insert	6.77
6945 22021	"C" Insert	6945 22151	"P" Insert	6.77
6945 22031	"D" Insert	6945 22161	"Q" Insert	6.77
6945 22041	"E" Insert	6945 22171	"R" Insert	6.77
6945 22051	"F" Insert	6945 22181	"S" Insert	6.77
6945 22061	"G" Insert	6945 22191	"T" Insert	6.77
6945 22071	"H" Insert	6945 22201	"U" Insert	6.77
6945 22081	"I" Insert	6945 22211	"V" Insert	6.77
6945 22091	"J" Insert	6945 22221	"W" Insert	6.77
6945 22101	"K" Insert	6945 22231	"X" Insert	6.77
6945 22111	"L" Insert	6945 22241	"Y" Insert	6.77
6945 22121	"M" Insert	6945 22351	"Z" Insert	6.77
6945 50291	"A-Z" Insert Set			106.84

Number Inserts

▶ 10 PER CASE.

ITEM NO.	PRODUCT	ITEM NO.	PRODUCT	EACH
6945 22251	"0" Insert	6945 22301	"5" Insert	\$6.77
6945 22261	"1" Insert	6945 22311	"6" Insert	6.77
6945 22271	"2" Insert	6945 22321	"7" Insert	6.77
6945 22281	"3" Insert	6945 22331	"8" Insert	6.77
6945 22291	"4" Insert	6945 22341	"9" Insert	6.77
6945 50301	"0-9" Insert Set			46.67

Hog Tattooer

- For use with inking pad (sold separately).
- Accepts interchangeable numerals or letters (sold separately).
- Recommended when frequent interchanging of characters is required.

NOTE: Poly-Nylon needlepoint tattoo inserts sold separately below. Metal needlepoint inserts also available. CALL FOR MORE INFORMATION.

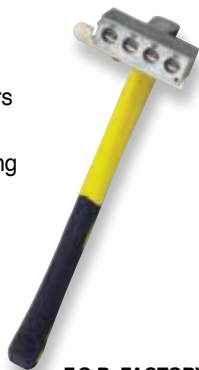

F.O.B. FACTORY

ITEM NO.	PRODUCT	EACH
6945 00611	4-Digit, Fiberglass Handle	\$83.95

Inking Pad

- Neoprene sponge rubber pad designed for use with tattooers.
- Aluminum handle.
- Replacement pads available.
- 5-1/2 inches square.



ITEM NO.	PRODUCT	EACH
6945 00221	Pad, Aluminum Handle	\$49.35
6945 0001	Replacement Pad	10.30

Custom Engraved Cold Ink Stamps



- For custom and processed meat.
- Bronze cast with plastic handle.

F.O.B. FACTORY

ITEM NO.	PRODUCT	EACH
3778 0001	Custom Square	
3778 0002	Custom Triangle	CALL FOR PRICING
3778 0012	Custom Rectangle	
3778 0008	Custom Round	

Pre-Cut Cold Ink Stamps

- Cold ink stamps for custom and processed meat.
- Overall stamp size: 1-1/2 inches x 3 inches.
- Bronze cast with plastic handle.



F.O.B. FACTORY

ITEM NO.	PRODUCT	EACH
7584 2392	"NOT FOR SALE"	\$338.57
3778 7883	"US Inspected and Condemned"	290.52
3778 22321	Est. # on "NOT FOR SALE" Stamp	249.99
3778 82521	USDA Inspected and Condemned w/Est #	270.31

Cold Ink Stamps

- Hand engraved brass with stainless steel border.
- Sharp, deep-cut engraved lettering produces a legible stamp every time.
- Each stamp has a serial number that is registered with the USDA Food Safety and Inspection Service.



NOTE: State Inspection Stamps also available. CALL FOR DETAILS.

F.O.B. FACTORY

ITEM NO.	PRODUCT	EACH
3778 1723	3/4" Dia. Federal Insp. Stamp	\$202.58
3778 1724	1-1/4" Dia. Federal Insp. Stamp	203.55
3778 1725	1-3/4" Dia. Federal Insp. Stamp	204.52
4313 00851	Small Round Plastic Handle	10.71
3778 4801	12" Hammer Handle	234.51
3778 4802	18" Hammer Handle	229.78
3778 4800	24" Hammer Handle	227.63
3778 4803	36" Hammer Handle	221.18

NOTE: Orders for Federal hot and cold stamps must be accompanied by the numbered FSIS Form 5200-7 authorization certificate signed by your inspector. CALL FOR DETAILS. Numbered dies cannot be returned, please verify all numbers before ordering.



Hog Tattoo Inks

Guaranteed fast dry formula.

- Meet all requirements for use in inspected plants.
- Quick drying formula Perma-Brite is used for roller markers and cold ink stamps.
- Regular drying formula purple ink is used for cold branding and stamping.



► FOUR, 1-GALLON BOTTLES PER CASE.

ITEM NO.	PRODUCT	EACH
3199 78121	A. GL-80 Economy Purple Ink	\$31.45
3199 51301	B. GL-31 Purple Perma-Brite Ink	41.55
3199 00051	C. GL-33 Red Perma-Brite Ink	51.45
3199 00061	D. #2 Brilliant Green Ink	21.65



CLD Green Denaturant Concentrate®

- Green color will permanently identify condemned product.
- Economical to use: mix 4-ounces concentrate with 1-gallon water.



► FOUR, 1-GALLON BOTTLES PER CASE.

ITEM NO.	PRODUCT	EACH
3199 78161	1 Gallon, Green	\$31.35

Liquid Denaturant

- Cleans easily with water.
- Can be used on meat and poultry; safe in pet food.
- A non-toxic, odor-free denaturant consisting of all natural ingredients.



► FOUR, 1-GALLON BOTTLES PER CASE.

ITEM NO.	PRODUCT	EACH
3199 36651	1 Gallon, Black	\$15.35
3199 3060	1 Gallon, Blue	27.95

Hog Tattoo Paste

Extra thick formula.

- Black paste-like ink is used with the needle-type hog slapper tattooer.
- Effective and fast method of tattooing hogs.
- Remains legible through scalding.



► 4 PER CASE.

ITEM NO.	PRODUCT	EACH
3199 58831	1 Gallon, Green	\$53.05

NOTE: Blue, Red and Black powdered denaturant available. CALL FOR DETAILS AND ORDERING INFO.

Detectomer® Sanitary Gaskets and O-Rings

Can be spotted by in-line x-ray inspection, metal detection systems and magnetic separators.

- Designed to work with existing stainless steel piping and hose systems.
- Available in a variety of materials — Tuf-Steel®, Buna, Silicone, EPDM, Acetal, FKM Fluoroelastomer, UHMW and Polyurethane.
- For products in aluminum pans and tins, metalized film packaging, metal or aluminum cans, flow-wrapping lines, hermetically sealed bags, etc.
- Color: metal detectable blue.

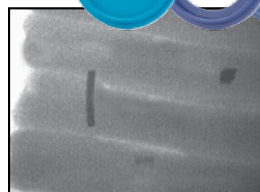

X-ray example of gasket pieces found in packaged meat.

ITEM NO.	SIZE	EACH
L475 00031	1.5"	\$1.33
L475 00011	2"	1.69
L475 00041	2.5"	1.90
L475 00021	3"	1.90
L475 00051	4"	3.23

DIN/ISO Gaskets

- Gaskets come with a Certificate of Compliance indicating the applicable lot number and all relevant order information to ensure full traceability at all times.
- Available in a variety of materials and sizes.

**CALL
800-456-5624
for more information.**

Prime Skinner Rollers, Pinch Blocks and Wear Strips

- Manufactured with durable Delrin plastic for added wear resistance.

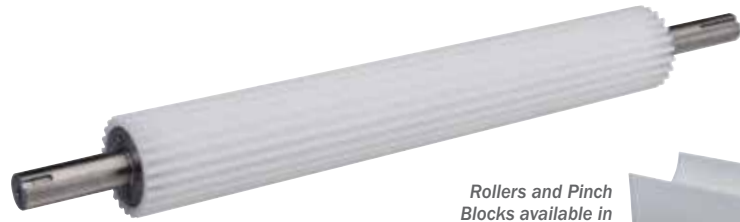

Rollers and Pinch Blocks available in 12", 18" and 24" sizes.



Peeler rollers available with 14, 18, 22, 24 and 28 teeth.



Delrin upper wear strips.



ITEM NO.	PRODUCT	SIZE	OEM#	EACH
H565 14241	10047-1424 Roller Skinner, 14-Tooth	24" Shaft	TS020J/TP028B	\$719.18
H565 18181	10047-1818 Roller Skinner, 18-Tooth	18" Shaft	SP020D/SP028B	661.13
H565 18241	10047-1824 Roller Skinner, 18-Tooth	24" Shaft	TS020C/TP028	719.18
H565 20241	10047-2024 Roller Skinner, 20-Tooth	24" Shaft	TS020A/TP028B	719.18
H565 22181	10047-2218 Roller Skinner, 22-Tooth	18" Shaft	SP020F/SP028B	654.68
H565 22241	10047-2224 Roller Skinner, 22-Tooth	24" Shaft	TS020H/TP028	719.18
H565 24121	10048-2412 Roller Skinner, 24-Tooth	12" Shaft	SK202B/SK028A	450.43
H565 24241	10047-2424 Roller Skinner, 24-Tooth	24" Shaft	TS020E/TP028	719.18
H565 26241	10047-2624 Roller Skinner, 26-Tooth	24" Shaft	TS020G/TP028B	719.18
H565 18251	10074-1824 Roller Skinner, 18-Tooth, Waterless	24" Shaft	20678	918.05
H565 28241	10074-2824 Roller Skinner, 28-Tooth, Waterless	24" Shaft	34412	740.68
H565 20121	10071-2012 Roller Skinner, 20-Tooth, Ertalyte	12" Shaft	TD1004	484.83
H565 28121	10071-2812 Roller Skinner, 28-Tooth, Ertalyte	12" Shaft	TD1004	484.83
H565 70121	10070-12 Block Pinch Skinner, Ertalyte	12" Shaft	TT031AE	583.73
H565 51121	100751-12 Block Pinch Skinner, Delrin	12" Shaft	TT031A	342.93
H565 52181	10042-18 Block Pinch Skinner, Delrin	18" Shaft	SP031A	473.00
H565 53241	10053-24 Block Pinch Skinner, Delrin	24" Shaft	TS031A	528.90
H565 10731	10073 Block Pinch Skinner, Waterless Delrin	24" Shaft	28486	661.13
H565 10491	10049 Upper Wear Strip, Delrin		TT130A	495.58
H565 10541	10054 Counter Roller Assembly	24" Shaft	15543	735.30

Poultry De-Boning Cones

- Cones made of stainless steel.
- Threaded for easy assembly.
- Cone shafts threaded on both ends.



ITEM NO.	PRODUCT	EACH
H179 10041	SS Poultry De-Boning Cone, Flat Bottom 4"	\$22.50
H179 10051	SS Poultry De-Boning Cone, Round Bottom 4"	30.80
H179 10081	8" Cone Shaft, Threaded	16.66
H179 10091	9" Cone Shaft, Threaded	17.50
H179 10101	10" Cone Shaft, Threaded	18.33

Char Marking O-Rings

- When precooking patties (for example, beef, chicken or soy patties) and other food products at a high production rate for fast food or for frozen dinners, it is often desirable to simulate the effect of broiling food products on a grill, which is commonly called "char marking" in the food processing industry.
- Char marking improves the eye appeal of the product by branding spaced parallel stripes, giving the appearance that the product was broiled over charcoal on spaced grill bars.



ITEM NO.	PRODUCT	EACH
H565 00031	6" Pegged	\$83.76
H565 00041	6" Blind	50.50
H565 00061	4" Pegged	64.91
H565 00071	4" Blind	40.51

FURTHER PROCESSING

FIND IT FAST

Seasoning Blends	452, 454, 456-457
Marinades	455
Jerky, Snack Stick and Venison Seasonings . . .	453-454, 456
Rubs, Cures and Tenderizer	456, 458
Curing Pump Accessories	457-458
Pumping Tables	461
Curing Pump and Replacement Parts	459
Injector Needles, Replacements	465-468
Food Slicer	463
Meat Grinder and Stuffing Tubes	463
Casings	465-468
Stuffers and Replacement Parts	469
Netting and Zip Ties	470-471
Smokehouse Supplies	472-473



Seasonings on pages 452-456 are for use with 25 pounds of meat, unless otherwise noted.

Sausage Seasoning Blends

▶ 24 BAGS PER CASE.

Pork Sausage #10

Legg's original "Southern Style" seasoning.



ITEM NO.	PRODUCT	BAG
3030 00271	8 oz. #10	\$3.45

Pork Sausage #6

Similar to #10, but with less black pepper and red pepper.

ITEM NO.	PRODUCT	BAG
3030 00281	8 oz. #6	\$3.30

Pork Sausage #29

Same great flavor as blend #6 with a medium spice level.

ITEM NO.	PRODUCT	BAG
3030 07631	8 oz. #29	\$3.50

Pork Sausage #7

A mild blend with red pepper, black pepper and sage.

ITEM NO.	PRODUCT	BAG
3030 25401	8 oz. #7	\$3.50

Pork Sausage #NS4

Similar to #7 but with nutmeg and ginger instead of sage.

ITEM NO.	PRODUCT	BAG
3030 25411	8 oz. #NS4	\$3.50

Maple Breakfast Seasoning, Pork Sausage #8

A popular sausage seasoning, appealing to all ages.

ITEM NO.	PRODUCT	BAG
3030 25521	10 oz. #8	\$4.05

Italian Sausage, Sweet #101

Contains all natural ground spices and a touch of sugar.

ITEM NO.	PRODUCT	BAG
3030 09941	8 oz. #101	\$3.50

Italian Sausage, Mild #102

A mild, yet full-flavored Italian sausage.

ITEM NO.	PRODUCT	BAG
3030 00391	8 oz. #102	\$3.50

Italian Sausage, Hot #103

Similar to #102 with crushed red pepper for a spicy kick.

ITEM NO.	PRODUCT	BAG
3030 00401	8 oz. #103	\$3.58



Bratwurst #104

Traditional German-style taste.

ITEM NO.	PRODUCT	BAG
3030 00411	11 oz. #104	\$4.45

Smoked Sausage #105*

"Southern Style" smoked sausage with visible crushed red pepper.

ITEM NO.	PRODUCT	BAG
3030 25421	11 oz. #105	\$3.99

Polish Kielbasa, Smoked #106*

Authentic Polish flavor with natural spices and garlic.

ITEM NO.	PRODUCT	BAG
3030 00431	11 oz. #106	\$4.80

Polish Kielbasa, Fresh #108

Delicious, full flavor perfect for grilling.

ITEM NO.	PRODUCT	BAG
3030 25481	11 oz. #108	\$4.70

Pork Sausage, Hot #109

Contains crushed and ground red pepper.

ITEM NO.	PRODUCT	BAG
3030 09931	9 oz. #109	\$3.95

Cajun Style Sausage #110

Red, black and white peppers, onion and garlic powders.

ITEM NO.	PRODUCT	BAG
3030 00451	12 oz. #110	\$5.48

Chorizo, Fresh #111

Full-flavored ethnic sausage seasoning, but not too hot.

ITEM NO.	PRODUCT	BAG
3030 09921	16 oz. #111	\$11.01

*These contain the proper amount of sodium erythorbate, for your convenience. Just add Quick Cure.

**For best results, use with Encapsulated Citric Acid.

Sausage Seasoning Blends, Continued

▶ 24 BAGS PER CASE.

Chorizo, Zesty #162

Bright red chili, cumin, garlic and a complexity of other South American spices and herbs.

ITEM NO.	PRODUCT	BAG
3030 01621	20 oz. #162	\$12.77

Hot Fresh Link Sausage #112

Ground and crushed red pepper, garlic powder and several spice extracts.

ITEM NO.	PRODUCT	BAG
3030 25431	11 oz. #112	\$5.18

Summer Sausage #114**

Everyone's favorite! Use with Encapsulated Citric Acid if desired, see right.

ITEM NO.	PRODUCT	BAG
3030 00471	18 oz. #114	\$5.65

Link Pork Sausage #115

"Southern Style" blend of spices and spice extracts.

ITEM NO.	PRODUCT	BAG
3030 25451	8 oz. #115	\$4.93

Bologna/Frankfurter #125*

"Old fashioned" flavor for bologna or frankfurters.

ITEM NO.	PRODUCT	BAG
3030 00501	14 oz. #125	\$5.47

Snack Sticks

- Use with beef, poultry or game meat.
- Formulated for restructured or solid muscle.
- Can be used for vacuum tumble, soak or dry rub.

▶ 24 BAGS PER CASE.

Snack Stick #116

Flavor pleasing to kids and grown-ups.

ITEM NO.	PRODUCT	BAG
3030 09911	18.5 oz. #116	\$6.32

Jalapeño Snack Stick #188

22.5-ounce bags.

ITEM NO.	PRODUCT	BAG
3030 00061	22.5 oz. #188	\$9.51



*These contain the proper amount of sodium erythorbate, for your convenience. Just add Quick Cure.
**For best results, use with Encapsulated Citric Acid.

Jalapeno Smoked Sausage #139

A complete blend of spices and Jalapeño peppers.

ITEM NO.	PRODUCT	BAG
3030 01391	14 oz. #139	\$6.31

Andouille, Smoked #163

Full bodied Cajun including peppers, garlic, onion and hints of herbs. Great for cured, smoked or fully cooked sausages.

ITEM NO.	PRODUCT	BAG
3030 01631	19.5 oz. #163	\$10.04

Bratwurst, Premium #170

A balance of sweet and warm spices including nutmeg, ginger and mace with other complimentary ingredients.

ITEM NO.	PRODUCT	BAG
3030 01701	19.5 oz. #170	\$7.41

Salami Seasoning Blend #186

A true "Old World" recipe with whole peppercorns.

ITEM NO.	PRODUCT	BAG
3030 01861	16-3/4 oz. #186	\$6.93

Jalapeno Summer Sausage #189

Old World flavor with diced Jalapeño for a hint of heat.

ITEM NO.	PRODUCT	BAG
3030 00071	22 oz. #189	\$9.15

Pepperoni Snack Stick #207

Fennel, caraway and garlic for a perfect Italian flavor.

ITEM NO.	PRODUCT	BAG
3030 00131	16.75 oz. #207	\$7.27

Barbecue Flavored Snack Stick Seasoning #157 for 10 Pounds of Meat

Sweet and spicy, with tomato, onion, garlic and a hint of hickory smoke.

ITEM NO.	PRODUCT	BAG
3030 01571	14 oz. #157	\$4.82

Pizza Flavored Snack Stick Seasoning #158 for 10 Pounds of Meat

A combination of Italian spices, garlic and tomato.

ITEM NO.	PRODUCT	BAG
3030 01581	8 oz. #158	\$3.96

Brown Sugar Maple Snack Stick #205 for 10 Pounds of Meat

Smooth, mellow, sweet flavor.

ITEM NO.	PRODUCT	BAG
3030 00321	7.8 oz. #205	\$3.65

Seasonings on pages 452-456 are for use with 25 pounds of meat, unless otherwise noted.

Jerky

- Use with beef, poultry or game meat.
- Formulated for restructured or solid muscle.
- Can be used for vacuum tumble, soak or dry rub.

▶ 24 BAGS PER CASE.

Jerky Seasoning #131*

Flavorful traditional jerky seasoning.

ITEM NO.	PRODUCT	BAG
3030 28901	13 oz. #131	\$5.38

Cajun Jerky #132*

Traditional jerky with a cajun kick.

ITEM NO.	PRODUCT	BAG
3030 28911	14.25 oz. #132	\$6.12

Peppered Jerky #133*

Black pepper takes traditional jerky to a spicy new level.

ITEM NO.	PRODUCT	BAG
3030 28921	13.5 oz. #133	\$6.12

Teriyaki Jerky #134*

A full-flavored Asian seasoning.

ITEM NO.	PRODUCT	BAG
3030 28931	20.25 oz. #134	\$7.78

Hot Teriyaki Jerky #135*

Teriyaki with an eye-opening twist.

ITEM NO.	PRODUCT	BAG
3030 28941	21.25 oz. #135	\$8.95

Jalapeño Jerky Seasoning #187*

ITEM NO.	PRODUCT	BAG
3030 00051	16 oz. #187	\$8.06

*These contain the proper amount of sodium erythorbate, for your convenience. Just add Quick Cure. **For best results, use with Encapsulated Citric Acid.

Ham Glaze #217

Sweet with a great blend of warm spices including cinnamon, clove and allspice.



▶ 24 BAGS PER CASE.

ITEM NO.	PRODUCT	BAG
3030 00161	4 oz. #217	\$2.35

Tinted Curing Salt

1 ounce per 25 pounds of meat.



▶ 200 BAGS PER CASE.

ITEM NO.	PRODUCT	BAG
3030 00361	1 oz. Tinted Curing Salt	\$0.36
3030 00301	4 oz. Tinted Curing Salt	1.30

Encapsulated Citric Acid

3 ounces per 25 pounds of meat.



▶ 240 BAGS PER CASE.

ITEM NO.	PRODUCT	BAG
3030 00031	3 oz. Encap. Citric Acid	\$2.65

Marinades

- Ideal for beef, pork, poultry, game meats or seafood.
- Blends formulated for use in vacuum tumblers or as a soak.
- Each makes 25 pounds of juicy product and adds no fat.
- All marinades are complete, including sodium phosphate.

▶ 24 BAGS PER CASE.

Natural Marinade #119

Spices and spice extracts to enhance natural flavor.

ITEM NO.	PRODUCT	BAG
3030 25531	7 oz. #119	\$5.15

Cajun Style #120

Zesty blend with red, white and black pepper.

ITEM NO.	PRODUCT	BAG
3030 00331	9.5 oz. #120	\$6.95

Lemon Pepper #121

Lemon and pepper in perfect proportions. Great for chicken and seafood.

ITEM NO.	PRODUCT	BAG
3030 00341	8.25 oz. #121	\$5.05

Hot and Spicy Marinade #122

Provides a spicy-hot taste. An increasingly popular blend.

ITEM NO.	PRODUCT	BAG
3030 25541	8 oz. #122	\$6.77

Italian #128

Flavorful and colorful Mediterranean blend.

ITEM NO.	PRODUCT	BAG
3030 03131	9 oz. #128	\$6.35

Barbecue Marinade #129

A medium heat blend with old time flavor.

ITEM NO.	PRODUCT	BAG
3030 25561	10.75 oz. #129	\$7.04

Mesquite #142

Southwestern flavor that has gained popularity.

ITEM NO.	PRODUCT	BAG
3030 07661	10 oz. #142	\$6.05

Lemon Butter #143

Especially pleasing with it's delicate flavor.

ITEM NO.	PRODUCT	BAG
3030 25571	8.75 oz. #143	\$5.95

Butter Garlic #144

Perfect proportions of butter and garlic. Great for beef and seafood.

ITEM NO.	PRODUCT	BAG
3030 03121	9.75 oz. #144	\$7.10

Greek #146

Spicy and colorful combination of pepper, garlic and herbs.

ITEM NO.	PRODUCT	BAG
3030 03151	9.25 oz. #146	\$5.95

Teriyaki Marinade #147

An excellent marinade for chicken, beef and stir-fry.

ITEM NO.	PRODUCT	BAG
3030 07651	15.5 oz. #147	\$8.93

Buffalo Wings #148

Perfect for marinating appetizers and cocktail items.

ITEM NO.	PRODUCT	BAG
3030 07641	9.5 oz. #148	\$6.86

Fajita #151

Great for either chicken or beef fajitas.

ITEM NO.	PRODUCT	BAG
3030 25621	7.5 oz. #151	\$6.00

Fajita, Zesty #154

Bolder flavor than original fajita marinade.

ITEM NO.	PRODUCT	BAG
3030 01541	10 oz. #154	\$6.53

New Orleans #166

A blend of whole herbs including rosemary, thyme and garlic. Great for pork, poultry and seafood.

ITEM NO.	PRODUCT	BAG
3030 01661	13.5 oz. #166	\$8.40

Garlic Parmesan #172

Equal parts garlic and Parmesan with visible herbs and spices make this marinade a "A Taste of Italy".

ITEM NO.	PRODUCT	BAG
3030 01721	12.25 oz. #172	\$8.59



* Requires Salt Cure for best results.

Seasonings on pages 452-456 are for use with 25 pounds of meat, unless otherwise noted.

Rubs

▶ 24 BAGS PER CASE.

Barbecue Seasoning and Rub #107

Use as a marinade or sprinkle on cooked meat.



ITEM NO.	PRODUCT	BAG
3030 00441	8 oz. #107	\$3.53

Barbecue Seasoning/Rub, Brown Sugar Sweet #136

Sugar based packed with a little punch.

ITEM NO.	PRODUCT	BAG
3030 01361	8 oz. #136	\$3.79

Buffalo Wing Rub #161

Warm, rich and tangy, dry topical rub with hints of heat and taste of vinegar. Suitable for all meats.

ITEM NO.	PRODUCT	BAG
3030 01611	8 oz. #161	\$7.05



Venison Seasonings

- Blended especially for venison, but works well with beef and pork.
- Cures sold separately, see page 457. • Made exclusively for Bunzl.

▶ 24 BAGS PER CASE.

Venison Pepperoni

ITEM NO.	PRODUCT	BAG
3030 00421	19.5 oz. Pepperoni	\$6.16

Venison Pastrami

ITEM NO.	PRODUCT	BAG
3030 00481	21.5 oz. Pastrami	\$6.16

Venison Salami

ITEM NO.	PRODUCT	BAG
3030 00461	22 oz. Salami	\$6.16

Venison Summer Sausage

ITEM NO.	PRODUCT	BAG
3030 00491	18 oz. Summer Sausage	\$5.32



Popular Seasoning Blends

▶ 24 BAGS PER CASE.

Meat Loaf #113 for 8 Pounds of Meat

Use with ground beef for a "homemade" flavor.

ITEM NO.	PRODUCT	BAG
3030 25441	14-1/2 oz. #113	\$5.46

Salisbury Steak #117

A "homemade" taste with onion, bell pepper and celery.

ITEM NO.	PRODUCT	BAG
3030 25461	8 oz. #117	\$4.40

Onion Steak #118

Full-flavor taste is sure to please.

ITEM NO.	PRODUCT	BAG
3030 25491	8 oz. #118	\$4.20

Taco #124

A popular blend with taste appeal for the whole family.

ITEM NO.	PRODUCT	BAG
3030 25471	12-1/2 oz. #124	\$7.20

Ham Spice #126

"California ham" spice flavor.

ITEM NO.	PRODUCT	BAG
3030 25501	8 oz. #126	\$4.54

Smoke Flavor #127 for 100 Pounds of Meat

Enhance your products with hickory smoke flavor.

ITEM NO.	PRODUCT	BAG
3030 25511	8 oz. #127	\$5.62

QUESTIONS? Call 800-456-5624

Flip-Top Gourmet Seasonings

Perfect for retail - customers will love them!



Beer Cheese Brat with Cheddar

- For use with 25 pounds of beef, poultry or game meat.
- Formulated for restructured or solid muscle.
- Can be used for vacuum tumble, soak or dry rub.

▶ 12 PER CASE.

ITEM NO.	PRODUCT	CASE
3030 0057	Garlic & Pepper Seasoning, 5.5 oz.	\$52.00
3030 0058	Red Dirt Rub, 6 oz.	56.00
3030 0059	Gourmet Steak Seasoning, 5 oz.	56.00

▶ 24 PER CASE.

ITEM NO.	PRODUCT	EACH
3030 00551	Beer Cheese Brat with Cheddar, 5 oz.	\$18.34



SIGN UP FOR OUR eDEALS

Get exclusive offers not found anywhere else!

eDEAL SIGN-UP FORM AVAILABLE ON OUR WEBSITE.

www.bunzlpd.com

GOURMET AND CHEESE BRAT SEASONINGS

PROCESSOR'S CHOICE

Cures

Award winning formula contains propylene glycol to prevent caking.



Quick Salt Cure

A 6.25% sodium nitrite cure is fast acting for hams, sausage and other meats.

▶ 50-POUND BULK BOX ONLY.

ITEM NO.	PRODUCT	BOX
A478 0625	Quick Salt Cure	\$74.43



Dry Rub Hickory Smoke Cure

Processed from salt, sugar, dextrose, maltodextrin, sodium nitrite (0.40%) and natural hickory smoke flavor.

▶ 50-POUND BULK BOX ONLY.

ITEM NO.	PRODUCT	BOX
A478 1001	Hickory Smoke Dry Rub	\$94.94

Dry Rub Maple Cure

Processed from salt, sugar, dextrose, natural maple flavor and sodium nitrite (0.40%).

▶ 50-POUND BULK BOX ONLY.

ITEM NO.	PRODUCT	BOX
A478 1002	Maple Dry Rub	\$90.19

Brown Sugar Cure

Processed from salt, brown sugar and dextrose base containing sodium nitrite (0.79%).

▶ FIVE, 10-POUND BAGS PER CASE.

ITEM NO.	PRODUCT	CASE
A478 0050	Brown Sugar Cure	\$101.46

Maple Sugar Cure

Processed the same as brown sugar cure, but with maple sugar.

▶ FIVE, 10-POUND BAGS PER CASE.

ITEM NO.	PRODUCT	CASE
A478 0075	Maple Sugar Cure	\$112.26

White Sugar Cure

Processed the same as brown sugar cure, but with white sugar.

▶ FIVE, 10-POUND BAGS PER CASE.

ITEM NO.	PRODUCT	CASE
A478 0051	White Sugar Cure	\$76.93

Steak Tenderizer

Mixed with potable water, one box makes 5 gallons of tenderizer.

- Double-strength action to improve tenderness and flavor.
- 1 gallon will treat between 500 to 600 pounds of steak.
- Prevents over-tenderizing and penetrates to the center of the cut.
- Apply solution to all surfaces, hold steak 1 to 3 hours before freezing.

PROCESSOR'S CHOICE



▶ FIVE, 10-POUND BAGS PER CASE.

ITEM NO.	PRODUCT	CASE
A478 1003	Dry Mix Tenderizer	\$53.97

YOU FOUND IT!

Call 800-456-5624

Mention you saw this ad in the Buyers Guide and we'll send you a **BPD MAGNETIC WORKPLACE FLASHLIGHT FREE** with your next order.*

Item# 7584 09241



*limit one per customer.

Cure-It Stainless Steel Curing Pump

Washdown design for the food processing industry.

- Powerful, 1/2 hp motor puts less stress on the pump, resulting in extended life — this is the most powerful motor available in a portable unit.
- High-velocity fan keeps the motor cool. • On/Off switch • Fully washdown, no exposed parts. • Only 4 bolts for easy maintenance.
- Shroud covers motor shaft with drain hole at bottom. • Pump is made of stainless steel, USDA/FDA materials.
- Includes: Complete Curing Pump Unit with motor, hoses, injection valve, artery needle, spray needle.
- Platform with smooth surface base has an open-end design to allow the unit to be easy to move and carry.
- The open ends also allow for easier cleaning underneath the unit. Water won't get trapped so less chance for bacteria to form.
- Rubber grommets on the base and under motor to assist with making the unit very quiet.
- The pressure release valve design allows user to easily adjust pressure with no tools needed.



Scan this QR Code with your mobile device to watch a video about the Cure-It Injector.



Oil filled valve for steady needle readout — no more trying to read a bouncing needle.

ITEM NO.	PRODUCT	EACH
K310 00161	Complete Curing Pump Unit	\$4,852.85

Curing Pump Replacement Parts

ITEM NO.	PRODUCT
K310 00011	A. Motor Assembly (Motor Box, Cord, Switch, Mounting Bracket)
K310 00021	B. Regulator
K310 00031	C. Pressure Gauge
K310 00051	D. Switch Assembly
K310 00041	E. Power Cord Assembly
K310 00061	F. Injector Gun Assembly
K310 00071	G. Strainer
K310 00081	H. Hose Kit (Hoses and Clamps)
K310 00091	I. Mounting Plate Assembly
K310 00101	J. Outlet Connection
K310 00111	K. T-Connection
K310 00121	L. 90° Connection
K310 00131	M. Rubber Feet (6-Pack)
5223 00411	N. 3-1/2-Inch Artery Needle
5223 00541	O. 6-Inch Spray Needle
K310 00191	P. Pump
K310 00181	Q. Pump Rebuild Kit
K310 00201	Motor/Pump Bushing (Not Shown)

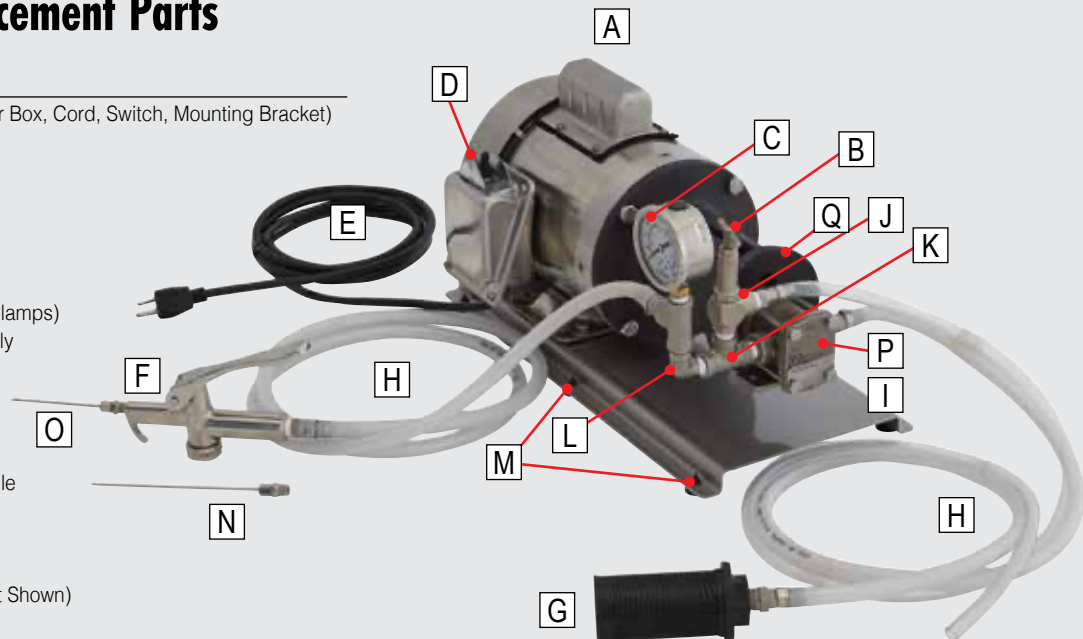

Questions about replacement parts and additional injector needles? CALL 800-456-5624

Stainless Steel Spray Needles

For use with multiple needle holders, see below.

- 16 hole spray needles. • 1/8 inch OD.

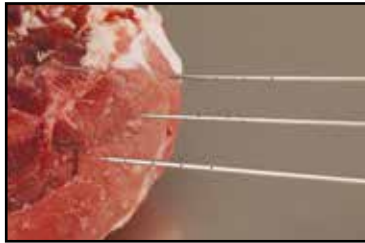

ITEM NO.	LENGTH	EACH
5223 00651	7-1/2"	
5223 00461	6"	
5223 00441	4-1/2"	
5223 00521	3-1/2"	\$37.35

Replacement Injection Valve Spare Part Kit

Foamer Kit Includes:

- Tip
- O-Ring
- Barrel Adjustment
- (2) Washers
- Spring Stop
- Stainless Steel Spring



ITEM NO.	PRODUCT	EACH
3013 30041	Valve Spare Part Kit.	\$73.95

Reinforced Clear Food Grade Hose

- Bonded, braid-reinforced wall will not balloon. • 25-foot roll.
- Maximum operating temperature is 180 °F.
- Hose remains flexible to -16 °F.



ITEM NO.	INSIDE DIMENSIONS	ROLL
3538 3514	1/4"	\$18.65
3538 1638	3/8"	23.25
3538 3512	1/2"	32.75
3538 3534	3/4"	61.95

Multiple Needle Holders

- Straight through inline design is easier to clean, without removing needles.
- Stronger stainless steel construction means extra long life.

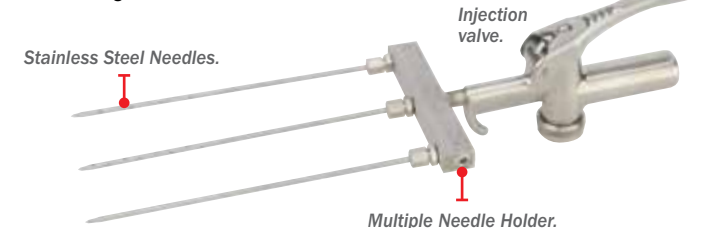

Stainless Injection Valve

- Highly polished, non-porous type 316 stainless steel.
- Nylon tip in valve stem. 1/8-inch needle connection. 3/8-inch NPT base connection.
- Improved hand grip and large hang-up hook.



NOTE: Valve Spare Part kit sold separately. SEE BELOW.

ITEM NO.	PRODUCT	EACH
3013 10041	Complete Valve.	\$167.48

Stainless Steel Artery Needles

Designed to screw directly into injection valve.

- 1/8-inch pipe thread connection. • Length: 3-1/2 inches.
- NOT for use in multiple needle holders.



ITEM NO.	OUTSIDE DIAMETER	EACH
5223 00501	0.187"	
5223 00411	0.148"	
5223 00531	0.125"	\$34.00

NOTE: Fits hand-held Stainless Injection Valve. SEE ABOVE.

Stainless Steel Spray Needles

Designed to screw directly into injection valve.

- 1/8-inch pipe thread connection. • 3/16 inch OD.



ITEM NO.	LENGTH	HOLES	EACH
5223 00451	7-1/2"	28	
5223 00541	6"	16	\$36.25

**Questions about injector needles?
CALL 800-456-5624**



Stainless steel needles attached to the multiple needle holder.

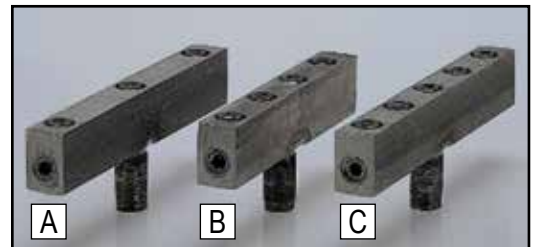

ITEM NO.	PRODUCT	SPACING	EACH
K069 00031	A. 3-Inline Holes	1-3/4"	\$148.95
K069 00041	B. 4-Inline Holes	1-1/8"	148.95
K069 00051	C. 5-Inline Holes	7/8"	148.95

Hand-Operated Brine Pump

- Made of sanitary, shockproof plastic.
- Check valve prevents air intake, for continuous operation.
- Includes nylon mesh intake filter and spray needle.



ITEM NO.	PRODUCT	EACH
3186 0010	Brine Pump	\$199.95
3186 5020	Replacement Needle.....	39.95

Stainless Steel Stand Alone Table

- For use in food preparation facilities, kitchens and restaurants.
- Fabricated from heavy-duty all welded 14-gauge T-304 stainless steel.
- Features a full size middle storage shelf and all welded construction.
- This unit is suitable for wet or harsh environments and is easy to clean.
- Equipped with adjustable bullet style feet for easy leveling.
- Dimensions: 24 inches x 20 inches x 30 inches.
- Model: TB101127.

Compact sized table can be used for small kitchen equipment.



NOTE: Arrives fully assembled.



ITEM NO.	PRODUCT	EACH
2990 1127	SS Stand Alone Table	\$660.50

Glass Brine Tester

- Accurately measures degree of salt concentration in brine.
- Graduated 0° to 100°.
- Length: 12 inches.



ITEM NO.	PRODUCT	EACH
F814 00011	Glass Brine Tester.....	\$47.56



▶ SEE PAGES 235-236

FOR STAINLESS
STEEL WORK TABLES

Stainless Steel "Roll-Over" Pumping Table

Table is built to safely roll over drums.

- 16-gauge type 304 stainless steel table with 6-inch back splash and pump shelf.
- Removable legs with 5-inch swivel casters for shipping and storage.
- Pumping surface has drain hole and return hose.
- Dimensions: table: 39 inches L x 28 inches D x 43-1/2 inches W with 6-inch back splash; shelf: 11 inches L x 28 inches W x 13 inches H.
- Shipping weight: 97 pounds.



NOTE: White drum, drum dolly, curing pump and table all sold separately.



ITEM NO.	PRODUCT	EACH
2990 7125	Pumping Table	\$1,633.55
6387 24831	32-Gallon Drum, White	42.08
6387 24941	32-Gallon Drum Lid, White	16.62
6387 33171	Round Twist-On Dolly	50.15



Replacement Needle for Belam

Item No. 5223 10351

332 mm OAL x 4 mm, 4 (63) + 3 (56) Holes

SPECIAL
ORDER
ITEM

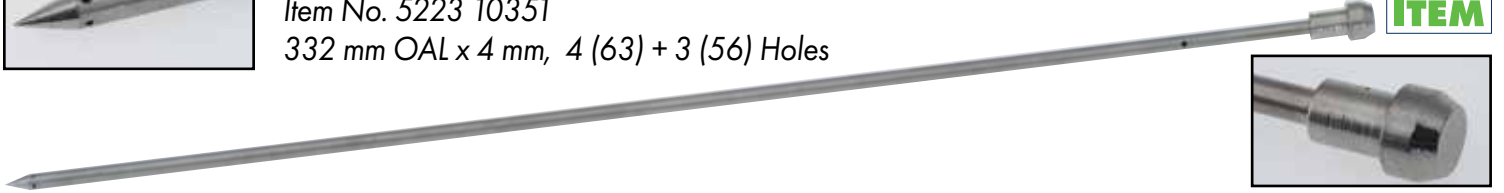

Replacement Needle for Fomaco

Item No. 5223 30031

05 mm OAL x 4 mm, 4 (67) holes – Double Needles

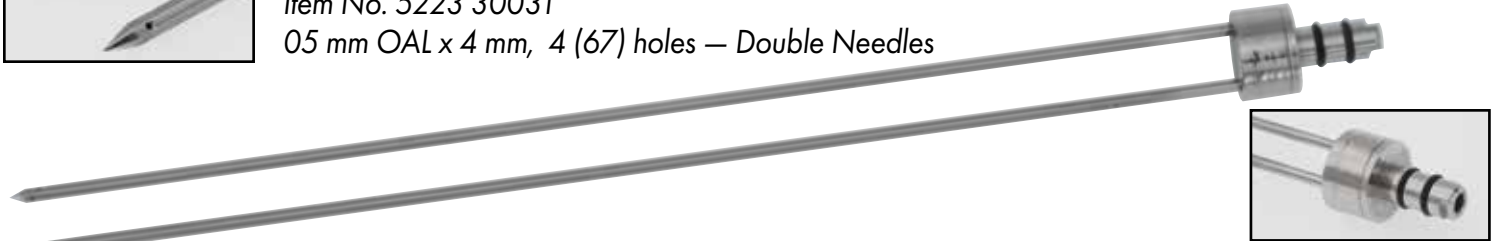

Replacement Needle for Fomaco

Item No. 5223 00251 - 371 mm OAL x 4 mm, 4 (57) Holes



Replacement Needle for MEPSCO

Item No. 5223 00041 - 10-1/4 mm x 4 mm x 4 Holes



Replacement Needle for Metalquimia

305 mm OAL x 3.2 mm, 4 (74) + 2 (56) Holes

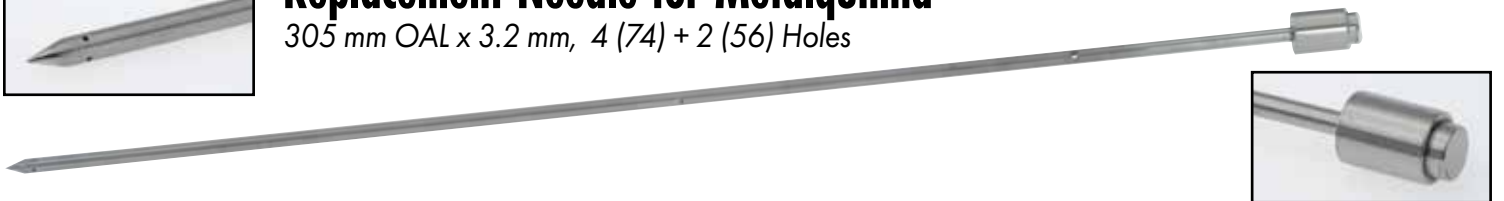

Replacement Needle for Metalquimia

260 mm OAL x 3 mm, 4 (53) + 2 (53) Holes

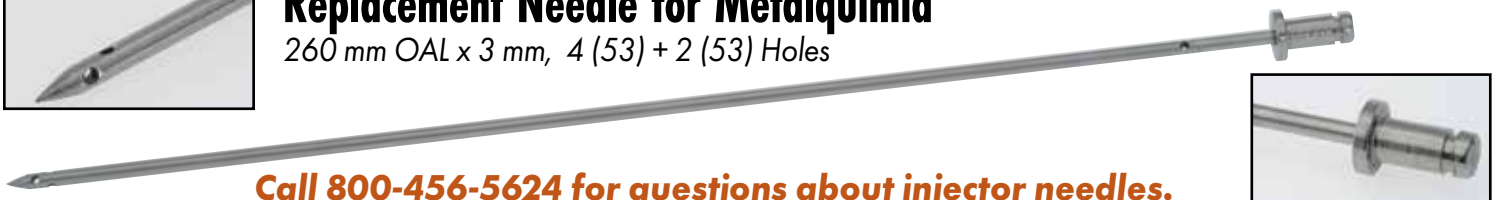

Call 800-456-5624 for questions about injector needles.



Replacement Needle for Metalquimia

305 mm OAL x 4.3 mm, 4 (74) + 2 (54) Holes

SPECIAL
ORDER
ITEM

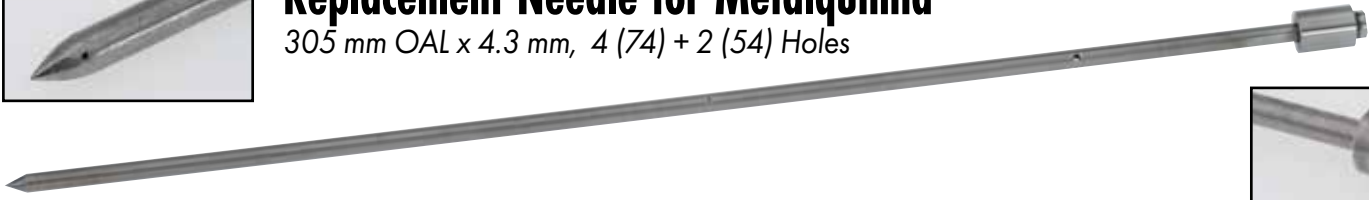

Replacement Needle for Metalquimia Style 89A

4.3 mm x 60 mm, 14 Hole Pattern

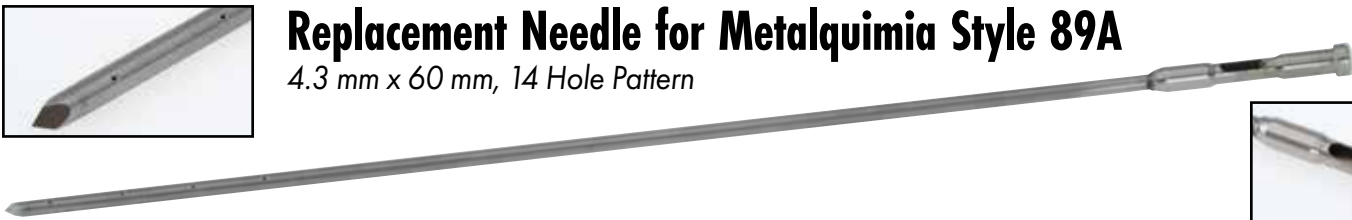

Replacement Needle for Townsend

Item No. 0012 08085 - 160 mm x 3/32-inch

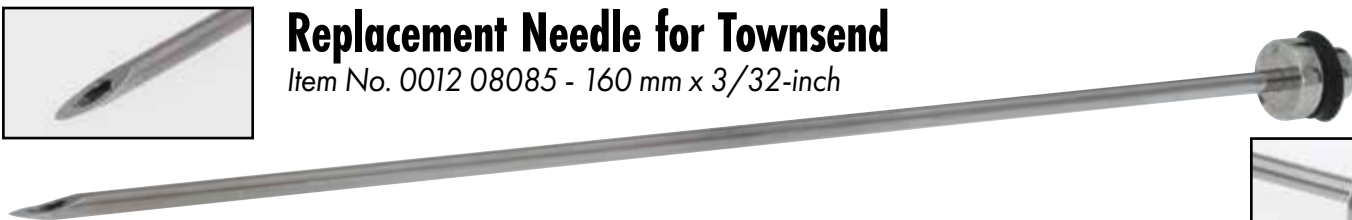

Replacement Needle for Schröder Wolf-tec

Item No. 5223 00561 - 300 mm OAL x 4 mm, x 4 0.8 Holes

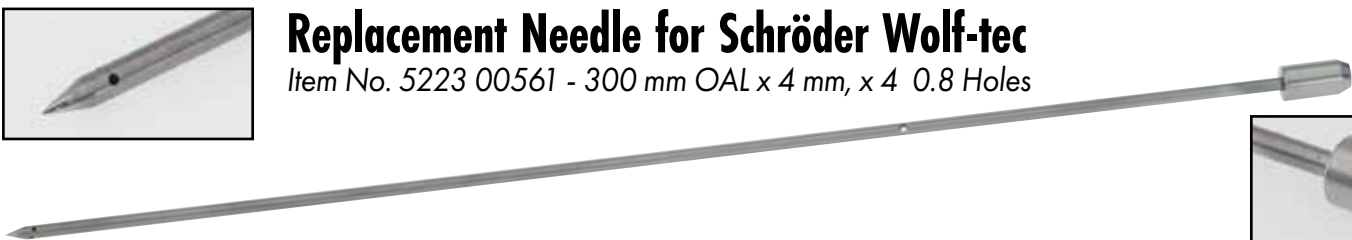

Replacement Needle for Schröder Wolf-tec IMAX 620

330 mm OAL x 4 mm, 4 (52) Holes

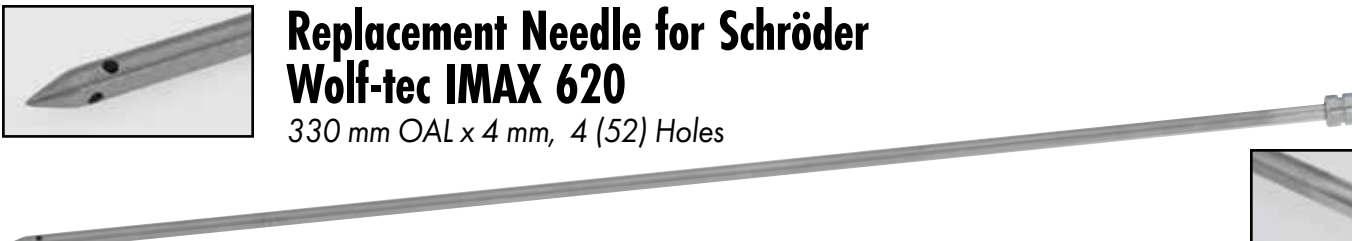

Replacement Needle for Schröder Wolf-tec

Item No. 0012 40841 - 387 mm OAL x 3 mm, 4 (53) + 2 (48) 1/16 Holes with Grooves

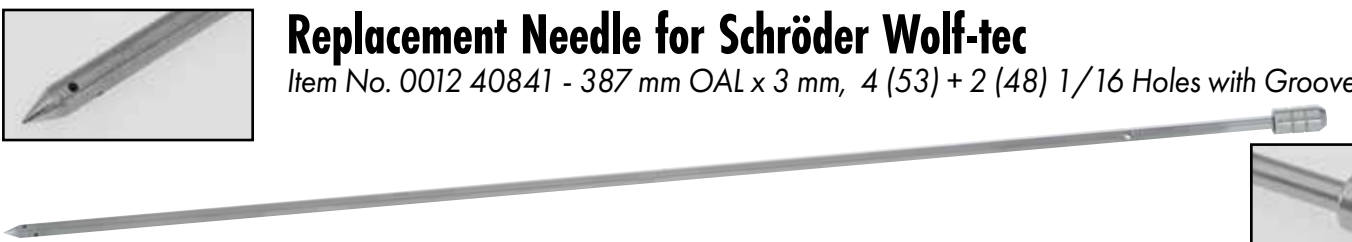

Call 800-456-5624 for questions about injector needles.

Chef'sChoice® Electric Food Slicer Model 665

- Rugged, die cast aluminum construction.
- Tilted design for fast, efficient slicing with metal food pusher.
- Stainless steel serrated blade with a blade cover for reduced friction and easier slicing.
- High torque motor and reliable smooth gear drive operation for continuous, non-stop slicing.
- Precision thickness control slices from deli-thin to approx. 1 inch thick.
- Dimensions: 18-1/2 inches L x 12 inches W x 12-1/2 inches H.
- Peak power over 1/4 hp.
- Weight: 15-1/2 pounds.

Chef'sChoice

SPECIAL
ORDER
ITEM



ITEM NO.	PRODUCT	EACH
5989 0007	Electric Food Slicer	\$304.15

Alfa MC-12, Stainless Steel, Electric Meat Grinder

- Heavy-duty, 1 hp, 115 V motor comes grease packed.
- 8 to 12 pounds per minute capacity (depending on product).
- Dimensions: 14 inches W x 12 inches D x 24 inches H.
- Weight: 66 pounds.



Unit Includes:

- Stainless Steel #12 Meat Grinder Head
- (2) #12 Plates (1/8 inch and 3/16 inch)
- (2) #12 Knives
- Worm
- Pan
- Sausage Stuffing Tube
- Stomper



ITEM NO.	PRODUCT	EACH
1044 00141	SS Electric Meat Grinder	\$1,836.00

Stuffing Tubes

Fill sausage casings without a meat stuffer.

- Bell shaped aluminum grinder horns attach directly to most popular meat grinders.



ITEM NO.	TUBE SIZE	GRINDER PLATE DIA.	OUTLET SIZE	SET OF 2
1044 90125	#12 . . . 2-3/4" 1/2"	\$48.41
1044 80125	#12 . . . 2-3/4" 3/4"	48.41
1044 22125	#22 . . . 3-1/4" 1/2"	48.41
1044 22345	#22 . . . 3-1/4" 3/4"	47.00
1044 32125	#32 . . . 3-15/16" 1/2"	48.41
1044 32345	#32 . . . 3-15/16" 3/4"	50.83

SMALL QUANTITIES SEALED IN ZIPLOC® BAGS FOR FRESHNESS!
 Processor's Choice collagen casings are sold in small quantities sealed in Ziploc® bags for freshness, just use what you need and reseal the bag. No more boxes of casings getting stale or collecting dust waiting for their next use. And all Processor's Choice bags have a convenient hang hole so that you can hang your casings for easy storage or retail sales. Processor's Choice casings comply with Halal specifications and requirements.

String-Tied, Non-Edible Collagen Casings

Recommended for summer sausage, salami and bologna.



Ziploc® closure for freshness with a hang hole for easy storage or display.



▶ 25 PER PACK - 12 PACKS PER CASE.

ITEM NO.	STUFF DIA.	LENGTH	COLOR	PACK	
				1-11	12+
E350 00125	53 mm (1-1/2")	12"	Clear	\$8.95	\$7.95
E350 00115	53 mm (1-1/2")	18"	Clear	10.95	9.95
E350 00105	53 mm (1-1/2")	18"	Mahogany	11.95	10.95
E350 00075	68 mm (2.68")	20"	Clear	13.95	12.95
E350 00065	68 mm (2.68")	20"	Mahogany	14.95	13.95

Collagen Middles/Rounds

Recommended for ring bologna, polish sausage and liver.

• Length: 18 inches. • Color: clear.



▶ 25 PER PACK - 12 PACKS PER CASE.

ITEM NO.	STUFF DIA.	PACK	
		1-11	12+
E350 00155	43 mm (1.69")	\$14.95	\$13.95

Venison Printed, String-Tied, Non-Edible Collagen Casings

• Length: 20 inches.



▶ 25 PER PACK - 12 PACKS PER CASE.

ITEM NO.	STUFF DIA.	LENGTH	COLOR	PACK	
				1-11	12+
E350 00085	68 mm (2.68")	20"	Clear	\$14.95	\$13.95
E350 00095	68 mm (2.68")	20"	Mahogany	14.95	13.95

Edible, Shirred Collagen Casings for Fresh Product

Recommended for breakfast sausage, brats, Italian and Polish sausage.

• Length: 15 meters (49.2 feet). • Color: clear.



▶ 24 PER PACK - 12 PACKS PER CASE.

ITEM NO.	STUFF DIA.	PACK	
		1-11	12+
E350 00035	21 mm (4/5")	\$84.95	\$82.95

▶ 12 PER PACK - 12 PACKS PER CASE.

ITEM NO.	STUFF DIA.	PACK	
		1-11	12+
E350 00145	32 mm (1.26")	\$76.95	\$74.95

Edible, Shirred Collagen Casings for Smoked Product

Great for snack sticks, hot dogs and smoked brats.

• Length: 15 meters (49.2 feet).



▶ 2 PER PACK, 12 PACKS PER BOX - 12 BOXES PER CASE.

ITEM NO.	STUFF DIA.	COLOR	BOX	
			1-11	12+
E350 15155	16 mm (3/5")	Brown	\$89.95	\$87.95
E350 00015	19 mm (0.74")	Brown	91.95	89.95
E350 00025	21 mm (4/5")	Brown	94.95	92.95
E350 00055	21 mm (4/5")	Clear	92.95	90.95
E350 00045	23 mm (0.9")	Clear	96.95	94.95

▶ 1 PER PACK, 12 PACKS PER BOX - 12 BOXES PER CASE.

ITEM NO.	STUFF DIA.	COLOR	BOX	
			1-11	12+
E350 00135	32 mm (1.26")	Clear	\$84.95	\$82.95

Edible Collagen Casings

In-stock for immediate delivery!

- Small order availability, large order pricing. • Uniform size and shape. • For use with uncooked product.
- Process casings are stronger and designed to withstand the heat and humidity of smokehouses.
- Convenient caddy contains pre-shirred strands, 50 feet long. • Finished product has tender “bite”.
- Casings comply with specifications and requirements and are certified.



▶ 9 BOXES PER CASE.

ITEM NO.	PRODUCT	SIZE	BOX NO.	BOX AMT.	BOX	
					1-8	9+
2989 14865	Brown Process	.19 mm x 50'	190	66	\$350.95	\$340.95
2989 69725	Clear Process	.21 mm x 50'	210	54	338.14	327.53
2989 69735	Clear Process	.23 mm x 50'	230	45	352.41	341.80
2989 69745	Fresh*	.21 mm x 50'	210	72	387.74	377.13
2989 69755	Fresh*	.32 mm x 50'	230	24	197.35	186.74

*Fresh casings are for uncooked product.

CONVERSION CHART	
1 INCH	= 25.4 mm
1 FOOT	= 0.3 meters
50 FEET	= 15 meters

String Tied Non-Edible Casings

- Uniform size and shape. • String tied one end, can be clipped or tied at other end. • Pre-cut in 18 or 24 inch lengths.
- In-stock for immediate delivery. • Collagen and nylon make it easy to peel.

▶ 100 PER BUNDLE.

ITEM NO.	PRODUCT	SIZE	BUNDLE
2989 07525	Clear, Round	.40 mm x 18"	\$85.27
2989 00025	Clear, Round	.43 mm x 18"	62.64
2989 69795	Clear, Straight	.72 mm x 24"	103.42



Shirred Meat Casings

132 feet of continuous casings — perfect for automated applications.

- Recommend soaking 20-30 minutes before use, but not required. NOT for smoking meats.
- Can be cooked at 90 °C/194 °F until desired internal temperature is reached.
- Safe Handling Instructions repeated on each casing. • Can be frozen. • PA/PE blend.
- Thermo shrinkable • For raw or cooked meat. • Not For Sale.



▶ 40 SHIRRS PER CASE.

ITEM NO.	PRODUCT	SIZE	COLOR	EACH	
				1-39	40+
F263 00681	A. Pork Sausage, Not For Sale	.65mm x 132'	Blue	\$21.45	\$19.95
F263 00691	B. Ground Beef, Not For Sale	.65mm x 132'	Red	21.45	19.95
F263 00671	C. Wild Game, Not For Sale	.65mm x 132'	Camo	21.45	19.95
F263 00831	D. Unprinted	.65mm x 132'	Clear	18.86	---
F263 00841	E. Unprinted	.65mm x 132'	White	20.37	---



NOTE: Custom sizes and printing available. Call for more details.

Clear Tubing Rolls, 3 Mil

▶ 30 ROLLS PER CASE.

ITEM NO.	PRODUCT	SIZE	ROLL
F263 00881	4" Tubing Roll	.4" x 2,000"	\$82.70
F263 00871	6" Tubing Roll	.4" x 2,000"	119.41
F263 00861	8" Tubing Roll	.4" x 2,000"	159.23



Fibrous, Non-Edible Casings

Casings are string-tied at one end and ready to fill.



Stock

Pre-Printed String-Tied

▶ CUT FIBROUS VENISON SAUSAGE CASINGS PACKED 100 PIECES PER BUNDLE - 10 BUNDLES PER CASE.

ITEM NO.	TRADE SIZE	FLAT WIDTH	FLAT LENGTH	COLOR	BUNDLE	
					1-9	10+
F263 00055	#2-1/2	.2-1/2"	20"	Clear	\$68.36	\$65.62
F263 00065	#2-1/2	.2-1/2"	20"	Mahogany	67.18	64.49
F263 00075	#4	.4"	24"	Mahogany	86.94	84.44

Plain String-Tied

ITEM NO.	TRADE SIZE	FLAT WIDTH	FLAT LENGTH	COLOR	BUNDLE	
					1-9	10+
F263 00085	#2-1/2	.2-1/2"	20"	Clear	\$67.75	\$64.86
F263 00095	#2-1/2	.2-1/2"	24"	Clear	77.41	74.49
F263 00105	#2-1/2	.2-1/2"	20"	Mahogany	76.87	74.06
F263 00115	#2-1/2	.2-1/2"	24"	Mahogany	88.90	86.15
F263 00125	#8	.8"	24"	Red	176.86	173.25
F263 00135	#8	.8"	24"	Clear	129.99	127.16



CONVERSION CHART

TRADE SIZE	DIAMETER
#2-1/2	2.76"
#4	3.23"
#8	4.84"

Semi-custom

Pride for your customer and name recognition for you.

- Minimums apply.



TIP: For non-edible collagen casings.

THE RULE OF 15

1. Fifteen minutes for soaking.
2. Fifteen degrees Celsius.
3. Fifteen percent salt solution in soaking water.

Full Custom

- The highest level of recognition available.
- You can choose the font and image color.



Work with our casing specialist to create your unique design. MINIMUMS APPLY.

SIGN UP FOR OUR eDEALS

Get exclusive offers not found anywhere else!

www.bunzlpd.com

WE ALSO OFFER **NATURAL CASINGS** CALL 800-456-5624 FOR MORE INFORMATION.



Holiday Casings

Dress up your product for the holidays!

- 2 inches x 12 inches, red fibrous string tied.

▶ 25 PER BUNDLE - 10 BUNDLES PER CASE.

ITEM NO.	PRODUCT	BUNDLE	
		1-9	10+
2989 57075	2" x 12" String Tied	\$22.84	\$21.52



Sausage Testing Knife with Fork

- 4-inch stainless steel blade.
- Knife and fork on opposite ends.
- Folds up with convenient pocket clip.

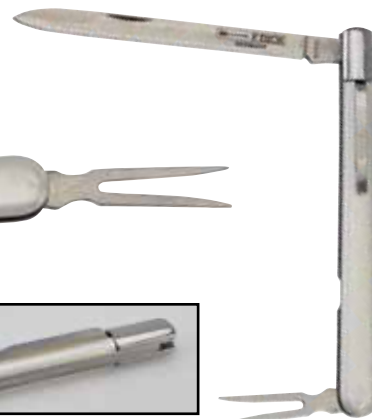

ITEM NO.	PRODUCT	MRF. NO.	EACH
3186 01111	4" Sausage Testing Knife	8200111	\$41.75



SHOP 24/7
bunzlpd.com



Need Help?
 Chat With Us
 Online!

STAY CONNECTED WITH US:



Where you can find out what's on sale, find updated product information, reviews and pricing.



F. Dick Tabletop Piston Stuffer

Perfect tabletop stuffer for butchers or processors who make their own sausage.

- Cylinder, support rods, base plate, gearbox and sidebars are constructed of stainless steel.
- Includes four hard plastic stuffing tubes: 3/8 inch, 1/2 inch, 3/4 inch and 1 inch D x 8-3/4 inch L.
- Piston and screw cap are made of nylon. • Simple two-speed operation.
- Shipping Weight: 65 pounds. • Completely disassembles for easy cleaning.
- 1-1/2-inch (38 mm) tube available separately.



NOTE: 1-1/2-inch (38 mm) tube available. Sold separately.

ITEM NO.	PRODUCT	EACH
3186 1500	30 lb Capacity	\$2,744.50
3186 10051	Pack of 4 Tubes	54.95

*Pack includes 1 of each sizes: 12 mm, 18 mm, 22 mm, 30 mm. Fits F. Dick Stuffers Only.

TABLETOP PISTON STUFFER REPLACEMENT PART REFERENCE CHART

PART DESCRIPTIONS	GRAPHIC
Double Spur Gear	
Double Driving Shaft	
Pinion	
Rack	
Crank, complete	
Nylon Piston w/Valve	
Connection Rod	
1. Air Valve, complete 2. 'O' Ring Sealing gasket	
Base Plate	
Cylinder Holder, set	
Rack Guide (2x)	
Cap Screw	
Cylinder	
Stuffing Tubes - 12 mm, 18 mm, 22 mm, 30 mm	
Disc, nut and cap (set 2x)	

To order replacement parts:

1. Use the chart on this page as a reference when ordering replacement parts.
2. Please have your stuffer on hand so that specific replacement parts may be identified.
3. Call for assistance.

Know your gear box shape when calling for replacement parts:

Model 905

Model 907

Model 908

Model 909

Gear Box Lid
Gear Box Screw and Cover Cap

Stainless Steel Mini Stuffing Table



- Working surface is crafted from heavy 14 gauge T-304 seamless stainless steel.
- Rustproof, corrosion resistant and easy to clean.
- Legs constructed with 16-gauge polished round stainless steel, 1-5/8 inches in diameter with sturdy rigid-truss cross supports.
- The working surface measures 33 inches D x 57 inches L and features a slope to a 2-inch sink-type drain and has 1-1/2-inch formed top retaining edges.
- Feet and legs allow up to 5-inches of overall height adjustment.
- Ships knocked-down with easy assembly.
- Extremely versatile and may be ordered with the operator notch section located on either side of the table.



ITEM NO.	PRODUCT	DIMENSIONS	EACH
2990 1030	SS Stand Stuffing Table	33-1/10" x 57-1/10" x 28" to 33"	\$2,012.70

TABLETOP STUFFER AND MINI STUFFING TABLE



EEZ-OUT Anti-Stick Lubricants



Increase yield and reduce waste.

- EEZ-OUT can be brushed, sprayed or dipped on netting, molds, plastic liners and trays for easy removal of meat, fish and poultry.
- Available as: Sunflower Lecithin base (allergen-free) 5-gallon container or Soy Lecithin base 55-gallon container.

ITEM NO.	PRODUCT	EACH
3274 0501	5 Gallon Sunflower Lecithin Base	\$328.50
3274 0155	55 Gallon Soy Lecithin Base	1,974.40

Chicken Marinating Net

- Marinate, ship and wash in the same bag.
- Bag does not trap marinade, so chicken can be easily drained.
- Marinate up to 32 pieces of chicken per bag.
- FDA approved.
- 12 inches x 26 inches.

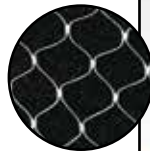

▶ 250 NETS PER BOX - 4 BOXES PER CASE.

ITEM NO.	PRODUCT	BOX
1600 93025	Chicken Marinating Net	\$58.55

Poly Smoking Net

- Unique pattern allows maximum smoke penetration and makes an attractive product.
- Woven, high-density netting is easily stripped from smoked product.
- For use in smokehouses up to 212 °F.
- 19 inch stretch width.
- Color: red.
- Bundled as 100 cut and pre-clipped pieces.



▶ 100 PIECES PER BUNDLE - 15 BUNDLES PER CASE.

ITEM NO.	LENGTH	BUNDLE
2607 00295	29"	\$20.94
2607 00335	33"	25.98
2607 00355	35"	26.77

▶ 100 PIECES PER BUNDLE - 10 BUNDLES PER CASE.

ITEM NO.	LENGTH	BUNDLE
2607 00375	37"	\$26.77
2607 00395	39"	26.77
2607 00415	41"	27.90
2607 00455	45"	30.29



Hog Ring Pliers and Rings

- Heavy-duty galvanized stapler is ideally suited for closing off neck of twisted plastic, cloth or mesh bags.
- Spring-loaded design feeds hog rings easily.
- Non-slip grips for positive crimping.
- Uses 11/16-inch C-style rings to close the open end of bags or casings.



Works great for closing off netting.

ITEM NO.	PRODUCT	EACH
6213 0012	Hog Ring Pliers	\$51.95

▶ 2,500 PER PACK.

ITEM NO.	PRODUCT	PACK
6213 8062	11/16" C-Style Rings for Pliers	\$16.95

Stainless Steel Stockinette Hooks

For Product Details ▶ SEE PAGE 472

▶ 100 HOOKS PER BOX.



ITEM NO.	PRODUCT	BOX
2321 2012	Stockinette Hooks	\$128.85

Stockinette Ham Smoking Net

- Rib knit bags are more tightly woven for strength.
- Locks in the meat juices for more finished product weight.



50/50 Poly/Cotton Stockinette

▶ 100 PIECES PER BUNDLE - 10 BUNDLES PER CASE.

ITEM NO.	PRODUCT	BUNDLE
2607 20385	36" Cut Length	\$23.29

Polyester Stockinette

▶ 100 PIECES PER BUNDLE - 40 BUNDLES PER CASE.

ITEM NO.	LENGTH	WEIGHT	BUNDLE
2607 96215	20"	4-5 lb	\$17.97
2607 96245	24"	6-8 lb	19.86
2607 96285	28"	8-10 lb	23.25
2607 96325	32"	12-14 lb	24.43
2607 96345	34"	14-16 lb	25.62
2607 96365	36"	16-18 lb	26.81
2607 96405	40"	20-22 lb	29.10
2607 96445	44"	26-30 lb	31.43



50/50 Poly/Cotton Stockinette

Cut nets at different lengths.

BEST VALUE: 25 Pound Roll/454 Yards

ITEM NO.	PRODUCT	EACH
3991 49401	25 lb Roll	\$236.70



Stainless Steel Zip Tyer

Reduce labor cost of rolling and tying by 75%.

- Constructed of polished stainless steel.
- Includes foot stirrup for easy loading of net and a "C" clamp to mount securely to table.
- Bottom plates are 9-3/4 inches wide.



NOTE: Includes foot stirrup for easy loading of net.

ZIP TYER DIMENSIONS					
SIZE	PRODUCT DIAMETER	FRONT OPENING	REAR OPENING	HORN LENGTH	HORN EXPANSION
Small	3" - 5"	3"	8-1/4"	23-5/6"	7-1/2"
Medium	4" - 9"	5"	11-1/4"	27-1/2"	9-1/4"
Large	8" - 12"	7-1/2"	13-1/4"	28-1/2"	12"

ITEM NO.	PRODUCT	EACH
7639 10351	Small	\$358.95
7639 10491	Medium	512.35
7639 18121	Large	579.32

E-Z Peel and Ultra Peel 18-Inch Cut and Clipped Meat Netting

- Tight weave holds meat firmly during cooking then relaxes prior to removal.
- Removes quickly and cleanly on the production line.
- Ideal for 7-12 pound hams. • Made of 100% polyester.



DIMENSIONS				
ITEM #	PRODUCT	SQUARES	DIAMETER	LENGTH
7275 75005	E-Z Peel-22	24	7"	18"
7275 75015	Ultra Peel-22	48	7"	18"

▶ 100 PIECES PER BUNDLE.

ITEM NO.	PRODUCT	BUNDLE
7275 75005	E-Z Peel-22	\$27.95
7275 75015	Ultra Peel-22	31.95

Cotton or Polyester Elastic Netting Rolls

- 150 foot rolls are always fresh and easy to work.
- Not to exceed 425 °F.

100% Cotton Netting

ITEM NO.	PRODUCT	ROLL
7275 68511	14-Square	\$15.95
7275 68521	16-Square	16.95
7275 68531	18-Square	17.95
7275 68541	20-Square	18.95
7275 68551	22-Square	21.95
7275 68561	24-Square	22.95
7275 68571	28-Square	23.95

Polyester Netting

ITEM NO.	PRODUCT	ROLL
7275 68601	12-Square	\$9.95
7275 68611	14-Square	10.95
7275 68621	16-Square	15.95
7275 68631	18-Square	15.95
7275 68641	20-Square	15.95
7275 68651	22-Square	16.95
7275 68661	24-Square	17.95
7275 68671	28-Square	19.95

DIMENSIONS			
SQUARES	FLAT WIDTH	STUFFING DIAMETER	STUFFING CIRCUMFERENCE
12	2-1/4"	4-1/2"	12-1/4"
14	2-1/4"	5"	14-1/4"
16	2-1/2"	5-1/2"	16-1/4"
18	2-3/4"	6"	18-3/4"
20	3"	6-1/2"	22"
22	3-1/4"	7"	25"
24	3-1/2"	7-1/2"	28"
28	4-1/2"	9"	36"



NOTE: We recommend the polyester netting for the easiest stripping. Use with EEZ-OUT lubricant, LEFT, for even easier removal.

Ham Overwraps

- Protects meat, film wraps and labels – reducing the cost and hassle of repackaging and returns.
- Prevents labels from being switched and handling is easier and more convenient for customers and employees.
- Allows customer to see the quality of meat products and enhances product eye appeal.



▶ 1,000 PER CASE.

ITEM NO.	SIZE	CASE
1600 0540	12" x 21"	\$170.55
1600 0550	12" x 24"	178.15

Heavy-Duty Smokesticks, 42 Inches Long

Rounded edges, easy to clean.

Perfect for all cooked products from hot dogs to hams.

A. Aluminum Wishbone Design

B. Aluminum Three-Sided Y-Design

C. Bell-Shaped 18 Gauge Stainless Steel Smokestick

- Ideal for heavy products, such as hams.

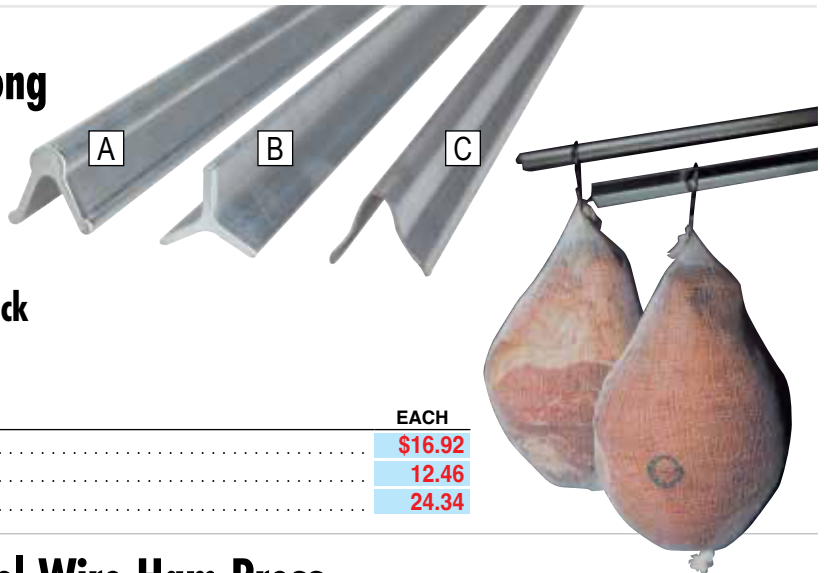

ITEM NO.	PRODUCT	EACH
3775 00581	A. Wishbone Smokestick (105/Case)	\$16.92
3775 42421	B. Aluminum Smokestick (58/Case)	12.46
2321 2242	C. SS Bell Smokestick (100/Case)	24.34



Stainless Steel Wire Ham Press

Wire press gives boneless ham an appetizing "grilled" pattern on top and bottom.

- All stainless steel wire screens and springs.
- Electropolished screens for easy clean-up.
- Reduce processing time, 1-inch square openings allow better smoke penetration.
- Single Press: 12 inches x 14 inches, 1/4-inch frame, 1/8-inch wire mesh. Includes 4 springs.
- Triple Press: 12 inches x 34 inches, 3/8-inch frame, 1/8-inch wire mesh. Includes 8 springs.

SPECIAL ORDER ITEM

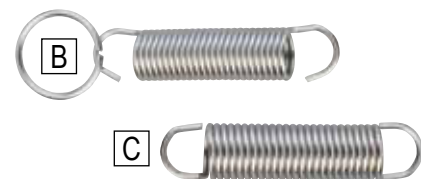

ITEM NO.	PRODUCT	F.O.B. FACTORY EACH
2321 26211	A. Single Ham Press Set	\$88.49
2321 26251	Triple Ham Press Set	202.28
2321 2631	B. Replacement Spring w/Finger Loop	7.15
2321 2630	C. Replacement Spring w/o Finger Loop	4.95

Bacon Hangers

A. Stainless Steel Bacon Hangers

- Frames and prongs are 3/32 inch dia., hook 3/16 inch dia.
- Prongs are machine ground to a sharp point, spaced 1-1/4 inches apart.

B. Safety Bacon Hangers with Grip

- Frames and prongs are 3/16 inch dia., hook 5/32 inch dia.
- Rough edges are completely eliminated — no crevices for grease and bacteria to accumulate.

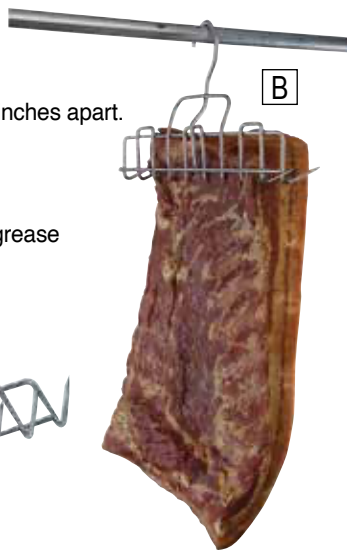
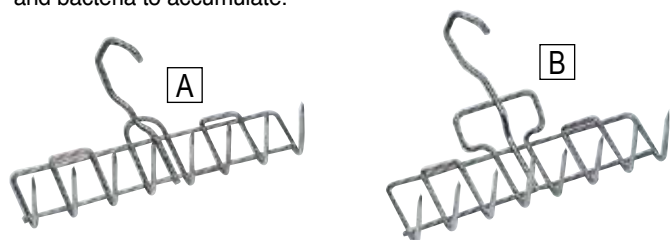

Stainless Steel Stockinette Hooks

- May be used with all types of smokesticks to hold product securely — no ripping or tearing.
- Allows the use of small bags and saves 4 inches of stockinette.



For Netting ▶ SEE PAGE 470-471

▶ 10 HANGERS PER CASE.

ITEM NO.	PRODUCT	WIDTH	TINES	EACH
2321 06651	A. Without Grip	.6-1/2"	6.	\$9.75
2321 8900	Without Grip	.8-3/4"	8.	9.85
2321 90111	Without Grip	.11-1/4"	10.	11.35
2321 89011	B. With Grip	.8-3/4"	8.	13.15
2321 1011	With Grip	.11-1/4"	10.	12.55

▶ 100 HOOKS PER BOX.

ITEM NO.	PRODUCT	BOX
2321 2012	Stockinette Hooks	\$128.85

Oven, Grill and Smokehouse Cleaner

Removes grease, soot, tar and other accumulations from smokehouse walls, floors and ceilings.

- With a pH of > 12.5 and caustic formulation, it offers the performance of traditional caustic oven, grill and smokehouse cleaners.
- Highly effective on grease, fats, oils, carbon, dirt and baked-on deposits on food prep and cooking surfaces such as ovens, grills, deep fryers, smoke houses and meat curers.
- The thickened formula sticks to vertical surfaces, to allow for longer dwell time and better cleaning.
- Keep away from heat, open flames, sparks.
- Meets A4 guidelines.



► FOUR, 1-GALLON BOTTLES.



ITEM NO.	PRODUCT	CASE
2117 0433	1-Gallon Bottles (4/Case)	\$80.53
ITEM NO.	PRODUCT	EACH
2117 0434	5-Gallon Pail	\$106.15

Hickory Sawdust

- Pungent, aromatic hickory sawdust.
- One bag contains nearly two bushels of sawdust.



NOTE: Pallet discounts available on 18+ bags. CALL FOR DETAILS.

ITEM NO.	PRODUCT	EACH
6065 4393	40-lb Bag	\$29.95

Liquid Smoke

- Natural hickory flavor and color in only 30 minutes of smoking.



ITEM NO.	PRODUCT	EACH
3101 4485	Zesti Liquid Smoke, 1 Gallon	\$165.57
F617 43331	Zesti Liquid Smoke, 5 Gallon	27.08
F617 10101	Mesquite 10 Liquid Smoke, 1 Gallon	71.15

Char Marking Rings

- When precooking patties (for example, beef, chicken, or soy patties) and other food products at a high production rate for fast food or for frozen dinners, it is often desirable to simulate the effect of broiling food products on a grill, which is commonly called "char marking" in the food processing industry.
- Char marking improves the eye appeal of the product by branding spaced parallel stripes, giving the appearance that the product was broiled over charcoal on spaced grill bars.



ITEM NO.	PRODUCT	EACH
H565 00031	6" Pegged	\$83.76
H565 00041	6" Blind	50.50
H565 00061	4" Pegged	64.91
H565 00071	4" Blind	40.51

Call 800-456-5624 for pricing.

WE'RE YOUR COMPLETE PACKAGING PARTNER

NATIONAL COVERAGE • OVER 40 YEARS EXPERIENCE

Take advantage of our dedicated
EQUIPMENT SERVICE TEAM.
Experienced in troubleshooting and
repairing all makes and models of
rollstock and vacuum chamber machines.

**LOWEST LABOR RATES
IN THE INDUSTRY**



800-888-3610

PREVENTIVE MAINTENANCE MATTERS

*Available to any customer with an estimated labor cost of \$1,100 — excluding cost of parts and travel expenses.
Service normally takes about 10 hours to complete — depending on the condition of the machine and availability of parts.*

- Operate faster and with fewer interruptions providing quality and consistency.
- Provides higher safety standards in food safety.
- Reduces costly repairs later.
- Detailed maintenance records as evidence of safety standards.
- Make the most of your investment.

Service will be billed as an hourly rate with a four-hour minimum. Travel expenses will also be billed which would include: travel time, air travel, rental car, lodging and a daily meal allowance.
If the service personnel drives to the customer's location, travel time plus mileage charges will apply.

PACKAGING

FIND IT FAST

Vacuum Pouches	476-479
Vacuum Pouch Loader	478
Vacuum Zipper Pouches and Oxygen Absorbers.	479
Bone Shields and Bone Guards.	480
Food Safe and NSF Certified Markers	481
Shrink Bags	481-487
Chub Film and Vertical Seal Film	487
Rollstock.	487-488
Lidding and Vacuum Skin Packaging.	489
Modified Atmosphere Bags	490
Cook Chill Bags	490
Custom Labels	491
Bag Sealers and Accessories.	491, 494-495
Poly Bags.	492-493
Shirred Meat Casings.	494
Locker Paper, Freezer Paper and Cutters	496
Tapes and Dispensers	497
Film Wrapping, Cutter and System	498
Wrapping Film and Dispenser	498, 502
Foam Trays and Soaker Pads.	499
Oxygen Absorbers and Safe Handling Labels.	499
Pouch Opener	500
Shrink Film and Low-Density Poly Bags.	501
Butcher Twine and Bag Closures	502
Deli Papers and Aluminum Foil.	503
Meat Boats, Deli Cups and Ziploc® Bags.	504
Sacks, Baskets and Cups	505
Temperature Control Packs.	505



3 Mil Standard Vacuum Pouches

The *FACTS* behind our pouches:

- FDA approved for food contact. • Contains NO BPA or melamine.
- Contains NO starches or animal by-products.
- Made from cast co-extruded film, more flexible and form fitting with an aggressive sealant.
- Easy to open when filling.
- Crystal clear with a glossy finish.

NOTE: These vacuum pouches are only for use in vacuum chamber machines.



CLARITY™

VACUUM POUCHES



ITEM NO.	SIZE IN INCHES	POUCHES PER BOX	BOX		
			1-7	8-14	15+
7500 1802	2.25 x 13	2000	\$60.07	\$54.61	\$43.95
7500 1803	2.5 x 10	2000	71.53	65.03	52.34
7500 1807	4 x 8	1000	32.87	29.88	24.05
7500 1808	4 x 10	1000	41.05	37.32	30.04
7500 1615	4.5 x 15	1000	96.22	87.47	70.40
7500 1812	5 x 7	1000	35.92	32.65	26.28
7500 1811	5 x 9	1000	46.20	42.00	33.80
7500 1815	6 x 8	1000	44.67	40.61	32.68
7500 1816	6 x 8.5	1000	47.75	43.41	34.94
7500 1817	6 x 10	1000	55.87	50.79	40.88
7500 1818	6 x 12	1000	67.02	60.92	49.04
7500 1819	6 x 15	1000	83.72	76.11	61.26
7500 1820	6 x 20	1000	111.63	101.48	81.68
7500 1824	7 x 8	1000	52.10	47.36	38.12
7500 1825	7 x 9	1000	58.60	53.27	42.88
7500 1826	7 x 11	1000	71.63	65.12	52.41
7600 1726	7 x 26	500	79.98	72.71	58.52
7500 1828	8 x 8	1000	59.53	54.12	43.56
7500 1829	8 x 10	1000	74.45	67.68	54.48
7500 1830	8 x 12	1000	89.30	81.18	65.34
7500 1831	8 x 15	1000	111.63	101.48	81.68
7500 1836	10 x 10	1000	93.03	84.58	68.07
7500 1837	10 x 12	1000	111.63	101.48	81.68
7500 1838	10 x 13	1000	120.97	109.97	88.51
7500 1839	10 x 15	1000	139.57	126.88	102.12

ITEM NO.	SIZE IN INCHES	POUCHES PER BOX	BOX		
			1-7	8-14	15+
7500 1840	10 x 18	500	\$83.73	\$76.12	\$61.27
7500 1841	10 x 20	500	93.03	84.58	68.07
7500 1842	10 x 22	500	102.35	93.05	74.89
7500 1843	10 x 30	500	139.57	126.88	102.12
7500 1851	12 x 12	1000	133.97	121.79	98.02
7500 1852	12 x 14	1000	156.35	142.14	114.40
7500 1853	12 x 15	500	83.73	76.12	61.27
7500 1854	12 x 16	500	89.30	81.18	65.34
7500 1855	12 x 18	500	100.47	91.33	73.51
7500 1856	12 x 22	500	122.80	111.64	89.85
7500 1861	14 x 16	500	104.22	94.74	76.26
7500 1862	14 x 20	500	130.25	118.41	95.30
7500 1863	14 x 24	500	156.32	142.11	114.38
7500 1866	16 x 16	500	119.07	108.24	87.12
7500 1867	16 x 20	500	148.87	135.33	108.93
7500 1868	16 x 24	500	178.65	162.41	130.72
7500 1869	16 x 26	250	96.75	87.95	70.79
7500 1870	16 x 28	500	207.23	188.39	151.63
7500 1873	18 x 18	500	150.72	137.02	110.28
7500 1874	18 x 22	500	184.22	167.47	134.79
7500 1875	18 x 28	250	117.23	106.58	85.78
7500 1878	20 x 25	250	116.32	105.74	85.11
7500 1879	20 x 28	250	130.25	118.41	95.30
7500 1880	22 x 34	250	174.00	158.18	127.32
7500 1883	24 x 30	250	167.47	152.24	122.54

Custom sizes are available. Call 800-456-5624 for more information.



**Proud to offer the
INDUSTRY'S FASTEST TURNAROUND TIMES
on custom size pouches.**

**MIX & MATCH SIZES
FOR DISCOUNTS AND
FREE SHIPPING!**

Safe Handling Labels Pre-printed on 3 Mil Vacuum Pouches



ITEM NO.	SIZE IN INCHES	POUCHES PER BOX	BOX		
			1-7	8-14	15+
7500 1904	6 x 8	1000	\$65.60	\$59.64	\$48.00
7500 1909	6 x 10	1000	78.30	71.18	57.29
7500 1905	6 x 12	1000	93.92	85.38	68.72
7500 1908	6 x 15	1000	111.05	100.95	81.26
7500 1910	8 x 10	1000	104.42	94.92	76.40
7500 1911	8 x 12	1000	120.12	109.20	87.89
7500 1912	8 x 15	1000	152.85	138.95	111.84
7500 1914	10 x 10	1000	145.77	132.52	106.66
7500 1916	10 x 13	1000	167.00	151.82	122.20
7500 1917	10 x 15	500	94.45	85.86	69.11
7500 1919	12 x 14	500	105.28	95.71	77.04
7500 1920	12 x 16	500	118.12	107.38	86.43
7500 1921	12 x 18	500	132.40	120.36	96.88
7500 1924	14 x 16	500	145.33	132.12	106.34
7500 1925	14 x 20	500	184.27	167.52	134.83

3 Mil High Barrier Deli Vacuum Pouches

Ideal for supermarkets and delis.

- For protection against UV lighting.
- A layer of EVOH provides an additional oxygen barrier.

ITEM NO.	SIZE IN INCHES	POUCHES PER BOX	BOX		
			1-7	8-14	15+
7500 1930	6 x 8	1000	\$81.62	\$74.20	\$59.72
7500 1931	6 x 10	1000	107.40	97.64	78.59
7500 1612	6 x 12	1000	128.85	117.14	94.28
7500 1937	7 x 12	1000	137.27	124.79	100.44
7500 1942	8 x 10	1000	129.18	117.44	94.52
7500 1943	8 x 12	1000	146.22	132.92	106.99
7500 1613	8 x 15	1000	194.42	176.74	142.26
7500 1948	10 x 13	1000	210.80	191.64	154.24
7500 1953	12 x 14	1000	268.53	244.12	196.49
7500 1954	12 x 18	500	172.78	157.08	126.43
7500 1957	14 x 16	500	170.10	154.64	124.46



CLARITY™

VACUUM POUCHES



VACUUM POUCHES

4 Mil Vacuum Pouches



ITEM NO.	SIZE IN INCHES	POUCHES PER BOX	BOX		
			1-7	8-14	15+
7500 1960	6 x 8	1000	\$69.88	\$63.53	\$51.13
7500 1961	6 x 10	1000	92.80	84.36	67.90
7500 1906	6 x 12	1000	111.25	101.14	81.40
7500 1966	8 x 10	1000	116.57	105.97	85.29
7500 1967	8 x 12	1000	132.92	120.83	97.26
7500 1968	8 x 22	500	120.02	109.11	87.82
7500 1616	10 x 13	500	98.43	89.48	72.02
7500 1973	10 x 15	500	102.63	93.30	75.10
7500 1907	10 x 16	500	107.83	98.03	78.90
7500 1974	10 x 20	500	132.50	120.45	96.95
7500 1979	12 x 14	500	115.15	104.68	84.26
7500 1980	12 x 18	500	146.65	133.32	107.30
7500 1981	12 x 22	500	178.63	162.39	130.71
7500 1984	14 x 20	500	187.25	170.23	137.01
7500 1987	16 x 20	500	215.88	196.26	157.96
7500 1988	16 x 26	250	145.88	132.62	106.74

5 Mil Vacuum Pouches

ITEM NO.	SIZE IN INCHES	POUCHES PER BOX	BOX		
			1-7	8-14	15+
7600 0029	8 x 12	1000	\$190.23	\$172.94	\$139.20
7600 1634	10 x 15	500	157.03	142.76	114.90

NOTE: These vacuum pouches are only for use in vacuum chamber machines.

Custom sizes available upon request.

3 Mil Gold Metallic Vacuum Pouches

Distinctive packaging to enhance your products visibility!

- Metallic design on back panel with a clear front panel.
- Differentiate yourself from the competition.

ITEM NO.	SIZE IN INCHES	POUCHES PER BOX	BOX		
			1-7	8-14	15+
7500 1991	4 x 9	500	\$52.43	\$47.67	\$38.37
7500 1992	6 x 8	500	72.02	65.47	52.70
7500 1996	8 x 10	500	113.82	103.47	83.28
7500 1997	8 x 12	500	124.97	113.61	91.44
7500 1999	10 x 15	500	208.58	189.62	152.62

NOTE: These vacuum pouches are only for use in vacuum chamber machines.

CLARITY™ VACUUM POUCHES



Custom Printed Vacuum Pouches

Choose your size.
Choose your style.
Choose from one-color or multi-color printing.



FOR CUSTOM POUCHES AND PRICING CALL 800-456-5624.

Stainless Steel Vacuum Pouch Loader

Easily load product into vacuum pouches!

- Four removable, 2-inch x 8-1/2-inch fingers.
- Easy to sanitize.
- Use one or more fingers to get the right size for your product.
- Made of stainless steel for strength and durability.



Fingers are removable and adjustable. Guide allows fingers to move easily from side to side.



ITEM NO.	PRODUCT	EACH
6119 21001	Vacuum Pouch Loader	\$229.94

3 Mil Boil-In Vacuum Pouches

- Specially formulated boil-in pouches are a full 3 mil thick.
- For use in temperatures up to 212 °F (100 °C).
- Ideal for sous vide cooking.

CLARITY™ VACUUM POUCHES



ITEM NO.	SIZE IN INCHES	POUCHES PER BOX	BOX		
			1-7	8-14	15+
7584 5014	6 x 8	2000	\$158.65	\$143.65	\$139.65
7584 5015	8 x 12	1000	158.65	143.65	139.65
7584 5017	10 x 12	1000	198.85	180.05	170.05
7584 5019	12 x 14	1000	274.75	248.85	238.85
7584 5020	12 x 18	500	176.55	159.85	142.85
7584 5021	16 x 26	250	157.45	142.55	132.55



Clear, 3 Mil Zipper Vacuum Pouches

- 3 mil construction of nylon/polyethylene for oxygen and moisture protection.
- Bottom fill pouches with tamper evident header, 1/4-inch hang hole and tear notch.



1/4" hang hole and EZ tear notch with zipper closure.



NOTE: These vacuum pouches are only for use in vacuum chamber machines.

ITEM NO.	SIZE IN INCHES	POUCHES PER BOX	BOX		
			1-4	5-9	10+
7264 0067	6 x 8	1000	\$154.91	\$132.67	\$106.78
7264 0069	6 x 10	1000	165.43	143.89	115.82
7264 6123	6 x 12	1000	191.35	173.50	139.65
7264 0065	8 x 10	1000	211.07	181.35	145.96
7264 0300	8 x 12	1000	213.25	185.86	149.60
7264 8153	8 x 15	1000	272.74	252.20	202.99
7264 0015	10 x 15	500	163.25	155.50	125.16

NEED SEAL BAR TAPE FOR YOUR CHAMBER MACHINE?
We have what you need!
Ask your CSR for details.

Colored, 5 Mil Zipper Vacuum Pouches

Colored vacuum pouches in affordable quantities.

- 5 mil pouch is constructed with biaxially-oriented nylon for puncture resistance and EVOH for high-barrier protection.
- Bottom fill pouches with tamper evident header, hang hole and tear notch.
- Ideal for jerky and other applications requiring extra barriers.
- 7-1/2-inch x 11-3/10-inch pouch has a zipper closure.
- Windowed on both sides for maximum viewing.



Hang hole and zipper closure.



▶ 1,000 POUCHES PER CASE.

ITEM NO.	COLOR	CASE	
		1-9	10+
7264 1135	Clear	\$305.95	\$285.95
7264 5100	Yellow	329.95	309.95
7264 5101	Red	329.95	309.95
7264 5102	Black	329.95	309.95

OxyFree™ Oxygen Absorbers

General purpose iron-based absorbers. Absorbs both O₂ and CO₂.

- Prevents spoilage, microbe development and oxidative deterioration during extended shelf life.
- Maintains oxygen level in package for less than 0.01% during the intended shelf life.
- Oxygen absorbers extend the shelf life of product. • Shape: rectangular loose sachet.

ITEM NO.	PRODUCT	BAG
G242 04305	Gram Weight: 1.2 +/- 0.1, 30cc (200/Bag)	\$4.95
G242 04505	Gram Weight: 1.8 +/- 0.1, 50cc (200/Bag)	5.95
G242 41005	Gram Weight: 3.1 +/- 0.1, 100cc (100/Bag)	3.95



6 Mil Clear PVC Bone Shields

For retail packaging when the clarity of the product cannot be compromised!

- Flexible bone shield for use in light-duty applications.
- Available in perforated rolls or as roll stock.

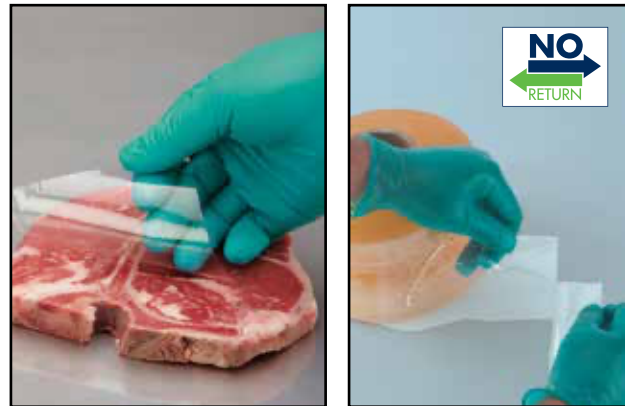

CLARITY™
FLEXIBLE PACKAGING

Perforated Clear PVC Sheets

ITEM NO.	SHEET SIZE	LENGTH	QTY.	CASE		
				1-4	5-9	10+
6614 0042	4" x 4"	.600'/Roll	.2 Rolls/Case	\$224.10	\$206.86	\$190.90
6614 0043	6" x 6"	.600'/Roll	.2 Rolls/Case	283.55	261.74	240.90
6614 0044	9" x 5"	.300'/Roll	.4 Rolls/Case	470.05	433.89	405.90
6614 0048	4-1/2" x 5"	.465'/Roll	.4 Rolls/Case	224.80	207.51	190.90
6614 0052	9" x 11"	.192.5'/Roll	.4 Rolls/Case	450.63	415.97	390.90

Roll Stock Clear PVC

ITEM NO.	WIDTH	LENGTH	QTY.	CASE		
				1-4	5-9	10+
6614 0051	4-1/2"	.675'/Roll	.2 Rolls/Case	\$288.97	\$266.74	\$245.90
6614 0053	9"	.775'/Roll	.1 Roll/Case	290.38	268.05	245.90
6614 0047	18"	.775'/Roll	.1 Roll/Case	577.22	532.82	495.90

MIX & MATCH SIZES FOR DISCOUNTS AND FREE SHIPPING!

Waxed Bone Guards

Maximum protection with deadfold capability.

- Sanitary wax-impregnated polypropylene retains its shape when placed over product prior to packaging.
- Protects against punctured packaging and eliminates mold growth.
- Not perforated. • 150-foot rolls.

CUSTOM PERFORATED ROLLS AVAILABLE.
Call 800-456-5624 for more information.

▶ SOLD BY CASE ONLY.

ITEM NO.	WIDTH	QTY.	CASE		
			1-4	5-9	10+
3242 9599	4-1/2"	.8 Rolls/Case	\$94.45	\$92.25	\$90.05
3242 9600	9"	.4 Rolls/Case	94.45	92.25	90.05
3242 9601	18"	.2 Rolls/Case	94.45	92.25	90.05



Rib-Eye Covers

For use after grading, in processing plants to cover the rib-eye and prevent meat from drying out.

- Constructed of high-slip polyethylene.
- One side of sheet has a non-stick coating.
- Size: 4-3/4 inch x 6-1/4 inch.



▶ 1,000 SHEETS PER PACK.

ITEM NO.	PRODUCT	PACK
3310 0005	Rib-Eye Covers	\$51.95



Plastic Bone Discs

Prevents pouch punctures when packaging bone-in hams.

- Three, 1/2-inch prongs keep disc securely in place on top of the bone.
- Sanitary white translucent plastic disc.
- 2-1/2 inch diameter disc easily covers bone.



ITEM NO.	PRODUCT	BAG
7687 0005	2-1/2" Plastic Bone Disc	\$164.40

▶ 3,000 PER BAG.

USDA/FDA Food Safe Markers

- Heavy-duty ink writes on oily, greasy and rusty surfaces.
- USDA authorized ink for use in Federally Inspected Meat and Poultry Plants.



ITEM NO.	COLOR	ITEM NO.	COLOR	
3199 40105	Black	3199 40305	Green	▶ 12 PAIR PER PACK. PACK \$50.95
3199 40205	Blue	3199 40405	Red	

DYKEM® SAFE-MARK NSF Certified General Purpose Markers



- Quick-drying permanent ink marker ideal for any surface: metal, glass, plastic, cardboard, rubber, shrink film, stretch wrap, etc.
- “Locked nib” prevents tip from falling out and into processing operations.
- Valve action mechanism prevents barrel ink from drying when cap is left off.
- Marks withstand temperatures spanning -20 °F to 475 °F.

ITEM NO.	PRODUCT	EACH
3112 09071	Black	\$6.59



Bunzl Processor Division — Your only Authorized Distributor of Genuine Cryovac® Shrink Bags.

Have you always wanted your product to have that CRYOVAC® case-ready look, but didn't need thousands of bags in one size?

CLARITY™ SHRINK BAG SMART PACKS



Now you can get the size you need, the quantity you want and **SAVE MONEY!**

Boxes easily fit at your work station. Unique dispensing system reduces waste*



Bunzl Processor Division is the Exclusive Distributor for the MultiVac P-Series Vacuum Chamber Machines.



With **CLARITY™ Smart Packs**, you can buy as few as 250 CRYOVAC® bags in several different sizes for less than a case of one size.

*Shrink bags larger than 12" wide or 24" long are not available in the dispenser box shown above, but are in a flat 250 count Smart Pack box.

CRYOVAC®

Sealed Air®

CLARITY™
FLEXIBLE PACKAGING

SHRINK BAG OPTIONS

TYPE	CUSTOM PRINTING	SERIES	ABUSE	SHRINK	BARRIER	MIN WIDTH	MAX WIDTH	MIN LENGTH	MAX LENGTH	USE
High-Shrink Bags	Yes	2000	MED	HIGH	HIGH	3.5"	16"	7"	32"	Cheese, Processed Meats, Retail Fresh Meats, Boneless
High-Abuse Bags	Yes	4000	HIGH	MED	HIGH	7"	16"	9"	24"	Cheese, Processed Meats, Retail Fresh Meats
Extra High-Abuse Bags	Yes	4000	X-HIGH	MED	HIGH	6.5"	14"	14"	24"	Hard Processed Meats and Cheeses Bone-In Fresh Meats (Ham, Turkey, etc.)
Gassy Cheese Bags	Yes	B2181 B2183	MED	HIGH	MED	9"	9"	9"	9"	Gassy Cheeses
Fresh Poultry Bags	Yes	E2300	MED	MED	NONE	7"	16"	14"	26"	Fresh or Frozen Poultry (Whole Chicken, Cornish Hens, Duck or Turkey)
Fresh Fish Bags	Yes	HP2700 HP2770	LOW	MED	NONE	8"	13"	12"	30"	Fresh Vacuum Packed Fish (Whole Fish and Fillets)

FINISHING OPTIONS

PACKAGING

- Carton
- Box
- Roll-Taped

TAPING

- Untaped (UT)
- Taped (TB)
- 2 Tape (EB - for hand pull)

**CUSTOM SHRINK BAG
SIZES AND BARRIERS
ARE AVAILABLE**
For more information
CALL 800-456-5624.

SHRINK BAG STYLES AND SEAL DESCRIPTIONS

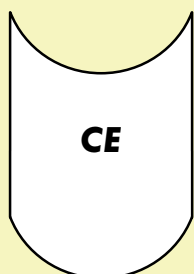

**CURVED
END SEAL**

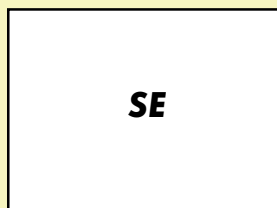

**STRAIGHT
END SEAL**



**CURVED
SIDE SEAL**

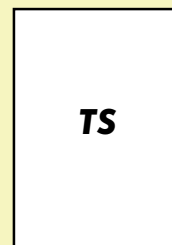

**STRAIGHT
SIDE SEAL**



**WEDGE
SIDE SEAL**

CRYOVAC® Sealed Air®



CLARITY™
FLEXIBLE PACKAGING

SERIES 2000 SHRINK BAGS

Series 2000 Medium-Abuse, High-Shrink, High Barrier Bags, Untaped

B2170 and B2171

- Good for cheese, smoked and processed meats, retail fresh meats, boneless hams, sausages and processed turkey.
- Standard gauge. • Color: clear.

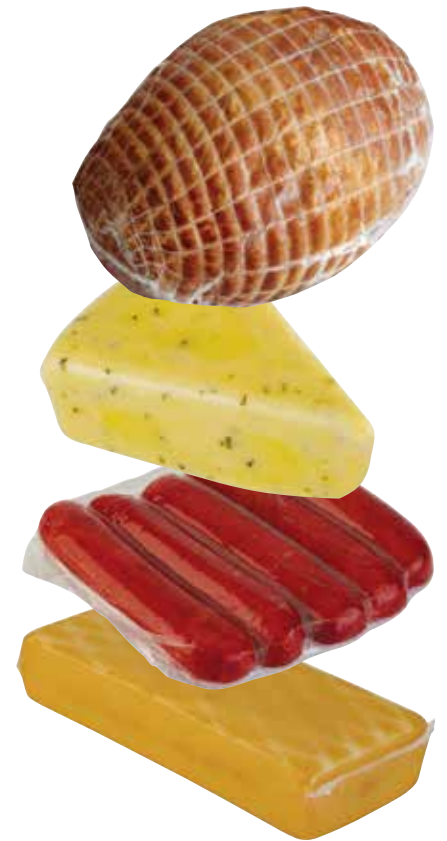

Series 2000 Taped Bags

B2170T and B2171T

- Standard gauge. • Color: clear.
- Seal: CE. • Quantity/Case: 3,500.

Case Pack			
ITEM NO.	SIZE	CASE	
		1-2	3+
1800 6464	4.5 x 10 ...	\$757.67	\$688.79
1800 6467	5.5 x 10 ...	796.53	724.12

Case Pack					
ITEM NO.	SIZE	SEAL	QTY/CASE	CASE	
				1-2	3+
1800 6355	3.5 x 9 ...	CE ...	3000	\$602.42	\$547.65
1800 6358	3.5 x 14 ...	CE ...	3000	731.35	664.86
1800 6360	4 x 8 ...	CE ...	3000	582.60	529.64
1800 6361	4 x 10 ...	CE ...	3000	598.37	543.97
1800 2850	4 x 12 ...	CE ...	3000	721.25	655.68
1800 6463	4.5 x 7 ...	CE ...	4000	778.87	708.06
1800 6367	4.5 x 10 ...	CE ...	3000	640.55	582.32
1800 6369	4.5 x 12 ...	CE ...	3000	709.95	675.95
1800 2851	4.5 x 14 ...	CE ...	3000	805.83	732.58
1800 6370	4.5 x 18 ...	CE ...	2500	735.23	668.39
1800 6373	5 x 7 ...	CE ...	3500	709.75	645.23
1800 6374	5 x 8 ...	CE ...	3000	611.25	555.68
1800 6375	5 x 9 ...	CE ...	3000	630.67	573.33
1800 6376	5 x 10 ...	CE ...	3000	655.28	595.71
1800 6379	5 x 13 ...	CE ...	3000	745.48	677.71
1800 6382	5.5 x 8 ...	CE ...	3000	628.93	571.76
1800 6388	6 x 7 ...	TS ...	4000	854.07	776.42
1800 6389	6 x 8 ...	CE ...	2500	536.73	487.94
1800 2852	6 x 8 ...	SE ...	2500	568.95	517.23
1800 2853	6 x 9 ...	SE ...	2500	589.12	535.56
1800 6391	6 x 10 ...	CE ...	2500	571.42	519.47
1800 6392	6 x 11 ...	CE ...	2500	603.58	548.71
1800 6393	6 x 14 ...	CE ...	2000	552.10	501.91
1800 6394	6 x 18 ...	CE ...	2500	806.40	733.09
1800 6398	6.5 x 8 ...	CE ...	2500	547.03	497.30
1800 6399	6.5 x 10 ...	CE ...	2500	585.58	532.35
1800 2854	7 x 8 ...	SE ...	3000	664.57	604.15
1800 6404	7 x 9 ...	CE ...	3000	689.82	627.11
1800 6405	7 x 12 ...	CE ...	2500	680.82	618.92
1800 1145	7 x 12 ...	SE ...	2500	680.53	618.67
1800 6406	7 x 14 ...	CE ...	2000	598.12	543.74
1800 6413	8 x 10 ...	CE ...	3000	824.52	749.56
1800 6414	8 x 12 ...	CE ...	2500	746.27	678.42
1800 6415	8 x 14 ...	CE ...	2000	645.47	586.79
1800 6416	8 x 16 ...	CE ...	1250	437.37	397.61
1800 6417	8 x 18 ...	CE ...	1250	467.65	425.14
1800 6419	8 x 23 ...	CE ...	1500	671.30	610.27
1800 0224	8 x 32 ...	CE ...	500	275.95	251.65
1800 6424	9 x 18 ...	CE ...	1250	530.90	482.64
1800 6426	9 x 28 ...	CE ...	750	466.62	424.20
1800 6428	10 x 15 ...	CE ...	1000	407.90	370.82
1800 6430	10 x 20 ...	CE ...	1000	497.20	452.00
1800 6431	10 x 24 ...	CE ...	1000	583.32	530.29
1800 6436	11 x 20 ...	CE ...	1000	541.92	492.65
1800 6440	12 x 16 ...	CE ...	1250	667.68	606.98
1800 6441	12 x 18 ...	CE ...	1250	731.38	664.89
1800 0261	13 x 18 ...	CS	1250	625.95	595.95
1800 6449	14 x 16 ...	CE ...	1000	667.92	607.20
1800 6451	14 x 20 ...	CE ...	1250	952.58	865.98
1800 6452	14 x 24 ...	CE ...	500	452.15	411.05
1800 6454	14 x 28 ...	CE ...	500	518.38	471.26
1800 6458	16 x 20 ...	CE ...	750	688.50	625.91
1800 6459	16 x 26 ...	CE ...	500	592.73	538.85
1800 6460	16 x 30 ...	CE ...	500	673.72	612.47

Smart Pack			
ITEM NO.	SIZE	QTY/BOX	BOX
7584 3304	3.5 x 14 ...	250	58.25
7584 3306	4 x 8 ...	250	46.38
7584 3307	4 x 10 ...	250	50.03
7584 3492	4 x 12 ...	250	57.43
7584 1268	4.5 x 7	250	73.03
7584 3313	4.5 x 10	250	51.02
7584 1267	4.5 x 12	250	87.20
7584 3493	4.5 x 14	250	64.17
7584 3316	4.5 x 18	250	67.17
7584 3319	5 x 7	250	48.45
7584 3320	5 x 8	250	48.67
7584 3321	5 x 9	250	50.23
7584 3322	5 x 10	250	52.17
7584 3325	5 x 13	250	59.38
7584 3328	5.5 x 8	250	50.08
7584 3334	6 x 7	250	51.02
7584 3335	6 x 8	250	51.30
7584 3495	6 x 8	250	54.37
7584 3494	6 x 9	250	56.30
7584 3337	6 x 10	250	54.62
7584 3338	6 x 11	250	57.70
7584 3339	6 x 14	250	65.93
7584 3340	6 x 18	250	77.07
7584 3344	6.5 x 8	250	52.25
7584 3345	6.5 x 10	250	55.95
7584 3496	7 x 8	250	57.00
7584 3349	7 x 9	250	54.92
7584 3350	7 x 12	250	65.07
7584 3554	7 x 12	250	71.20
7584 3351	7 x 14	250	71.43
7584 3358	8 x 10	250	65.48
7584 3359	8 x 12	250	71.32
7584 3360	8 x 14	250	77.10
7584 3361	8 x 16	250	83.58
7584 3362	8 x 18	250	89.37
7584 3363	8 x 23	250	106.93
7584 1266	8 x 32	250	220.60
7584 3368	9 x 18	250	101.47
7584 3370	9 x 28	250	148.70
7584 3372	10 x 15	250	97.45
7584 3374	10 x 20	250	118.77
7584 3375	10 x 24	250	139.35
7584 3380	11 x 20	250	129.47
7584 3384	12 x 16	250	127.62
7584 3385	12 x 18	250	139.77
7584 1265	13 x 18	250	205.90
7584 3393	14 x 16	250	159.58
7584 3395	14 x 20	250	182.77
7584 3396	14 x 24	250	216.05
7584 3398	14 x 28	250	247.70
7584 3402	16 x 20	250	219.42
7584 3403	16 x 26	250	283.20
7584 3404	16 x 30	250	321.90

CRYOVAC® Sealed Air®

CLARITY™
 FLEXIBLE PACKAGING

Series 4000 High-Abuse and Extra High-Abuse, Medium Shrink, High Barrier Bags

B4770 and B4172

- Good for processed meats, retail bone-in fresh meats, bone-in ham cuts, bone-in smoked turkey, smoked ham in netting, glazed ham, dry sausage and hard cheeses such as Parmesan.
- Use heavy-duty bags for bone-in products. • Standard gauge. • Untaped bags. • Color: clear.

▶ SEE PAGE 482

For Seal Styles and Descriptions



Case Pack

ITEM NO.	SIZE	SEAL	QTY/CASE	CASE	
				1-2	3+
1800 6284	7 x 9	CE	3000	\$696.23	\$632.94
1800 6286	7 x 25	CE	1000	436.98	397.26
1800 6288	7.5 x 24	CE	1000	448.95	408.14
1800 6307	10 x 13	CE	2500	988.27	898.42
1800 6317	12 x 20	CE	1250	798.72	726.11
1800 6318	12 x 24	CE	500	360.28	327.53
1800 6324	14 x 24	CE	1250	961.43	874.03
1800 6326	14 x 20	CE	500	456.65	415.14
1800 5249	15 x 24	CE	500	495.45	450.41
1800 6330	16 x 24	CE	500	532.45	484.05

Heavy-Duty Bags

1800 2931	6.5 x 21	CE	1500	\$689.33	\$626.67
1800 0084	10 x 14	SE	1000	496.82	451.65
1800 6334	10 x 20	CE	750	452.25	411.14
1800 0345	13 x 16	CS	1,250	744.18	676.53
1800 6348	14 x 24	CE	500	547.50	497.73

Smart Pack

ITEM NO.	SIZE	QTY/BOX	BOX
7584 3414	7 x 9	250	\$55.45
7584 3416	7 x 25	250	104.40
7584 3418	7.5 x 24	250	107.25
7584 3437	10 x 13	250	89.10
7584 3447	12 x 20	250	152.67
7584 3448	12 x 24	250	180.75
7584 3454	14 x 20	250	183.75
7584 3456	14 x 24	250	218.18
7584 3525	15 x 24	250	260.33
7584 3460	16 x 24	250	267.13

Heavy-Duty Bags

7584 2920	6.5 x 21	250	\$114.67
7584 2921	10 x 14	250	112.28
7584 3464	10 x 20	250	144.13
7584 1264	13 x 16	250	186.05
7584 3478	14 x 24	250	261.58

CUSTOM SIZES AVAILABLE. Call 800-456-5624 for more information.

Gassy Cheese Bags, Medium Abuse, High Shrink, Medium Barrier

B2181 and B2183

- Good for gassy cheese such as Swiss, allowing carbon dioxide to escape the packaging while maintaining product freshness.
- Standard gauge. • Color: clear. • Untaped.

NOTE: For SMART PACK seal type, see CASE PACK seal description column.

Case Pack

ITEM NO.	SIZE	SEAL	QTY/CASE	CASE	
				1-2	3+
1800 4756	5 x 9	TS	4000	\$886.75	\$806.14
1800 4757	5 x 9	WS	4000	886.75	806.14

Smart Pack

ITEM NO.	SIZE	QTY/BOX	BOX
7584 3528	5 x 9	250	\$58.02
7584 3531	5 x 9	250	58.02



Bunzl Processor Division — Your only Authorized Distributor of Genuine Cryovac® Shrink Bags.



BUNZL
Processor Division
KOCH SUPPLIES

FREE
SHIPPING*

FREE GROUND SHIPPING
when you place an order for \$500
or more from **THIS BUYERS GUIDE!**

*FREE SHIPPING does NOT include UPS Next Day Air, UPS 2nd Day or UPS 3rd Day Select. Certain items may not qualify. This offer is good only on orders shipped UPS Ground in the 48 contiguous states. Based on dimensional weight, we will determine the most efficient means of shipment, either UPS or LTL. Products may ship by truckline.

Fresh Poultry/Turkey, Medium Abuse, Medium Shrink, Non-Barrier Shrink Bags

E2300

- Good for fresh and frozen poultry products of all sizes.
- Standard gauge. • Untaped bags. • Color: clear.

Case Pack					
ITEM NO.	SIZE	SEAL	QTY/CASE	CASE	
				1-2	3+
1800 5086	7 x 14	CE	2000	\$596.00	\$541.82
1800 0038	8 x 16	CE	1250	434.70	395.18
1800 2190	9 x 16	CE	2000	741.22	673.83
1800 2736	9 x 18	CE	1250	501.17	455.61
1800 2191	10 x 16	CE	1250	499.65	454.23
1800 0044	10 x 18	CE	1250	536.82	488.02
1800 0045	11 x 18	CE	1250	558.20	507.45
1800 5326	12 x 18	CE	1250	674.22	612.92
1800 2878	16 x 26	CE	750	875.03	795.48

Smart Pack			
ITEM NO.	SIZE	QTY/BOX	BOX
7584 5086	7 x 14	250	\$73.58
7584 3558	8 x 16	250	93.77
7584 3481	9 x 16	250	88.53
7584 3559	9 x 18	250	95.78
7584 3482	10 x 16	250	95.48
7584 3560	10 x 18	250	115.77
7584 3561	11 x 18	250	126.57
7584 2928	12 x 18	250	143.33
7584 3501	16 x 26	250	278.78

NOTE: For SMART PACK seal type, see CASE PACK seal description column.

10K OTR Fresh Fish, Low Abuse, Medium Shrink, Non-Barrier Bags

HP2700 and HP2770

- Good for fresh seafood: tuna loins, mahi, sea bass fillets, bulk fillets such as salmon, catfish, cod, flounder and tilapia.
- Standard gauge. • Untaped bags. • Color: clear.

Case Pack					
ITEM NO.	SIZE	SEAL	QTY/CASE	CASE	
				1-2	3+
1800 2199	8 x 12	SE	2500	\$703.32	\$639.38
1800 2203	13 x 19	SE	1250	876.67	796.97
1800 2872	14 x 24	CE	750	666.38	605.80
7584 0524	11 x 25	SE	500	306.90	279.00
7584 0525	11 x 30	SE	500	357.35	324.86

Smart Pack			
ITEM NO.	SIZE	QTY/BOX	BOX
7584 3488	8 x 12	250	\$77.80
7584 3490	13 x 19	250	167.55
7584 3500	14 x 24	250	212.30
7584 1263	10 x 25	SE	193.12
7584 1262	11 x 30	SE	223.35

CUSTOM SIZES AVAILABLE.
Call 800-456-5624
for more information.

CLARITY™
FLEXIBLE PACKAGING

CRYOVAC®
Sealed Air®



FREE SHIPPING*

FREE GROUND SHIPPING when you place an order for \$500 or more from THIS BUYERS GUIDE!

*FREE SHIPPING does NOT include UPS Next Day Air, UPS 2nd Day or UPS 3rd Day Select. Certain items may not qualify. This offer is good only on orders shipped UPS Ground in the 48 contiguous states. Based on dimensional weight, we will determine the most efficient means of shipment, either UPS or LTL. Products may ship by truckline.

Custom Printed Shrink Bags

Choose from one-color, multi-color or photographic image printing.



▶ SEE PAGE 482
For More Shrink Bag Options

Custom Printed Rollstock Film



▶ SEE PAGE 491
For Custom Printed Labels

Chub Film and Vertical Form Seal Film



WE OFFER A VARIETY OF CUSTOM OPTIONS:

- Random repeat, scatter or registered print.
- Up to 10 colors; with gloss or matte finish.
- Surface or reverse print laminate.

CUSTOM SHRINK BAGS, ROLLSTOCK, CHUB FILM AND VERTICAL FORM SEAL FILM

Forming and Non-Forming Barrier Rollstock Films

More Robust

- Wider operating window handles a greater variety of forming depths over a broader temperature range making the film more forgiving and easier to use.
- Requires less heat and creates less demand on equipment.
- Premium 11-layer cast coextruded technology.

Better Machinability

- Film conforms easier to machine tooling.

Improved Clarity

- Up to 50% clearer. • Improves retail shelf appeal.

Seals through contaminants

- E-seal technology is the choice for value-added product applications such as marinated, pumped, brine, sauced and seasoned and cooked.

Greater Memory

- Improved shrink creates a tighter, better looking package.

Approved for heat treatments

- Cook-in applications up to 180 °F for six hours.
- Post-pasteurization conditions up to 212 °F for 30 minutes — Microwave re-heating up to three minutes on high power for previously cooked foods.

High-Barrier Rollstock Films

3-Inch Core

ITEM NO.	PRODUCT	COLOR	MIL	WEB WIDTH (+1/-1)	LENGTH
7584 04571	Forming	Clear	5	323	2000'
7584 04311	Forming	Clear	5	423	2000'
7584 05401	Forming	Clear	5	463	2000'
7584 04601	Forming	Clear	7	323	1500'
7584 04591	Forming	Clear	9	323	1200'
7584 04321	Forming	Clear	7	423	1500'
7584 05221	Forming	Clear	7	463	2000'
7584 05551	Forming	Clear	9	362	1200'
7584 04331	Forming	Clear	9	423	1200'
7584 05781	Forming	Black	3	441	3000'
7584 04581	Non-Forming	Clear	3	306	3000'
7584 04771	Non-Forming	Clear	3	355	3000'
7584 04341	Non-Forming	Clear	3	406	3000'
7584 05121	Non-Forming EZ PEEL	Clear	3	406	3000'
7584 04901	Non-Forming (for 10 pin)	Clear	3	418	3000'
7584 05391	Non-Forming	Clear	3	444	3000'
7584 05061	Non-Forming	Black	3	306	3000'
7584 05351	Non-Forming	Black	3	355	3000'
7584 04431	Non-Forming	Black	3	406	3000'
7584 04961	Non-Forming	Black	5	416	2000'

CLARITY™

FLEXIBLE PACKAGING



Black Non-Forming Rollstock

- High gloss.
- High barrier.
- High run speed.
- Stocked in common sizes.
- Highest opacity percentage UV light blocking in its class.
- High quality 11 layer cast film.
- Compatible for retail packaging of ground, bulk or linked sausage and steaks.



Our packaging professionals are ready to help you with all your rollstock needs. On-site packaging consultation is available for FREE.
CALL FOR MORE INFORMATION.

OUR ROLLSTOCK IS DESIGNED TO BE COMPATIBLE WITH MANY BRANDS OF MACHINES



* All films are manufactured for BUNZL Processor Division and are not made, licensed, sponsored or approved by the original equipment manufacturer.

All products listed are replacement films only; they are not original equipment and BUNZL Processor Division is not affiliated with the manufacturers listed.

All references to original manufacturer's equipment are for identification purposes only. All BUNZL films are manufactured to exacting specifications using the highest quality materials.

Lidding

We offer top lidding films for thermoformed rigid trays and the form fill and seal process for modified atmosphere packaging (MAP). Our shrink lidding films are coextruded high barrier with superior antilog technologies and crystal clear transparency; perfect for tray sealing.

- Full range of barrier and non-barrier lidding films. • Choose from lock, peelable and peel/reseal technology.
- Superior clarity. • Enhanced anti-fog properties. • Registered or random printing available.
- Films available for sealing to all rigid substrates (PE, PP, PET, APET, RPET).



Vacuum Skin Packaging (VSP)

Use the right skin film to make your product stand out from competitors' products on the supermarket shelf.

- VSP can be used with semi-rigid films, pre-made trays and coated board stock.
- Provides consumer appeal without compromising shelf life and packaging security.
- Vertical display ability allows for maximum product exposure while conserving space.
- 10-K OTR and Barrier options available.



**SIGN UP
FOR OUR
eDEALS**

**Get exclusive offers
not found anywhere else!**

www.bunzlpd.com

Modified Atmosphere Bags

- 7 layer coextruded technology utilizing high performance resins to offer a wide range of possible barrier levels.
- Available in nylon, EVOH or PE options; clear and colored material.
- Proprietary sealant technology for better seals through contaminants.
- Compatible with all machines.



CALL 800-456-5624 TO ORDER.



3 Mil Sealed On One End Cook Chill Bags

- After filling, the open end is then closed with a clip or impulse sealer.
- Bag is sealed on one end.
- Estimated Volume: 1/2 gallon.
- Size: 10 inches x 18 inches.



On larger bags an angled seal adds extra strength and a surface to hold onto.

CLARITY™
C5000 COOK CHILL BAGS



NOTE: Additional sizes available. CALL FOR DETAILS.

Features of Cook Chill Bags:

- **LONGER PRODUCT LIFE** — Oxygen and moisture barriers provide increased protection of flavors. The low rate of gas transmission safeguards volatile flavor components throughout distribution.
- **SUPERIOR DURABILITY** — Easily withstands the rigors of handling and distribution. Tears are extremely difficult to initiate or propagate. This toughness permits the filled bag to be tumbled inside the chiller without danger of rupture.
- **POSITIVE CLOSURE** — Bag is pre-clipped or sealed on one end. After filling, the open end is then closed with a clip or heat sealed.
- **IMPROVED SANITATION** — From the time they are placed in the kettle for cooking, foods are untouched. They can be pumped directly into the cook chill bag at above-pasteurization temperature, which assures greater protection against bacteria.

▶ 3 PER CASE.

ITEM NO.	QTY./CASE	QTY./CASE	CASE	
			1-2	3+
E179 2107	Cook Chill Bags	1000,000	\$280.95	\$276.95

12-Inch Foot Operated Sealer

- Foot operated to keep both hands free for more accurate sealing.
- Adjustable timer allows you to seal bags of various thicknesses.



Call today for information about our **SEALER STARTER KITS!**



Hands-free foot operated control.



ITEM NO.	PRODUCT	EACH
E179 34001	Foot Sealer	\$545.22

Bag Sealer

Liquid tight seals on all poly bags up to 5 mil thickness.

- No warm-up time needed. Just plug in!
- Grounded 3-prong cord included.
- 110 V.
- Rheostat temperature control knob.
- Fast impulse seals all types of plastic bags, as well as laminates.

Parts Kit includes:

- (4) Heat Wires
- (3) Teflon Covers
- (2) Teflon Insulators



ITEM NO.	PRODUCT	EACH
2490 2108	8" Bag Sealer	\$229.95
2490 4413	8" Parts Kit	107.63
2490 0057	12" Bag Sealer	286.00
2490 4414	12" Parts Kit	124.00

Adjustable Ring Stand

- Specially designed to fit our cook-chill bags and perfect for hand-fill.
- Durable, light-weight, stainless steel construction.
- Oversized base for stabilization.
- Adjustable height: 12 - 21 inches.



Bags loop over the ring stand for easy fill.

ITEM NO.	PRODUCT	EACH
E179 34011	Ring Stand	\$436.50

Custom Labels

CALL 800-456-5624 TO ORDER.



SPECIAL ORDER ITEM

COMMON SIZE & SHAPE OPTIONS:

3" x 2"	Rectangle
3" x 5"	Rectangle
3" x 6"	Rectangle
3-1/2" x 8"	Rectangle
4" x 2"	Rectangle*
4" x 2-1/2"	Rectangle
4" x 3"	Rectangle*
4" x 4"	Rectangle*
4" x 6"	Rectangle
4" x 8"	Rectangle
4" x 10"	Rectangle
4" x 12"	Rectangle
4" x 14"	Rectangle
2"	Circle
3"	Circle

* Most popular sizes for meat.

ORDER CUSTOM LABELS

Please have the following information available.

Environment: Freezer Refrigerator Other

Label Use: Packaged Meat Bottles Other

Label Shape: Rectangle Circle Square Oval

Thermal: No Yes Brand/Model _____

Number of Designs: _____ (minimum 50/design)

Quantity Per Roll: 1000+ Core: 1 Inch 3 Inch

Questions? _____

Total Quantity: _____

In-Stock Poly Bags

- 1 and 2-pound meat bags feature 1-inch bottom gusset for added burst protection.
- Stock printed bags include 'Safe Handling' warning labels on the back of the bag.
- Quality 2 mil white opaque and clear polyethylene. • Sizes listed are flat dimensions.

▶ 1,000 BAGS PER BOX - 10 BOXES PER CASE.

ITEM NO.	PLAIN, NO PRINTING	BOX	
		1-9	10+
3546 0001	1 lb, 4.25" x 10.5", Opaque White	\$40.95	\$38.95
3546 0002	2 lb, 4.25 x 13.5", Opaque White	42.95	40.95
3546 0005	5 lb, 6" x 18", Opaque White	63.95	61.95
3546 0010	10 lb, 8.5" x 21", Opaque White	112.95	109.95
3546 5427	1 lb, 4.25" x 10.5", Clear	40.95	38.95
3546 5428	2 lb, 4.25" x 13.5", Clear	42.95	40.95

ITEM NO.	PRINTED, STANDARD SAFE HANDLING	BOX	
		1-9	10+
3546 2135	1 lb, 4.25" x 10.5", Opaque White	\$40.95	\$38.95
3546 2136	2 lb, 4.25 x 13.5", Opaque White	42.95	40.95

ITEM NO.	KEYHOLE DESIGN, (FOR SALE)	BOX	
		1-9	10+
3546 1001	1 lb, 4.25" x 10.5", Pork Sausage	\$40.95	\$38.95
3546 1002	2 lb, 4.25" x 13.5", Pork Sausage	42.95	40.95
3546 1005	5 lb, 6" x 18", Pork Sausage	63.95	61.95
3546 0011	1 lb, 4.25" x 10.5", Ground Pork	40.95	38.95
3546 2001	1 lb, 4.25" x 10.5", Ground Beef	40.95	38.95
3546 2002	2 lb, 4.25" x 13.5", Ground Beef	42.95	40.95
3546 0015	2 lb, 5" x 11.25", Ground Beef	42.95	40.95
3546 2005	5 lb, 6" x 18", Ground Beef	63.95	61.95
3546 2700	1 lb, 4.25" x 10.5", Italian Sausage	40.95	38.95
3546 2897	1 lb, 4.25" x 10.5", Hot Italian Sausage	40.95	38.95
3546 2564	1 lb, 4.25" x 10.5", Ground Chicken	40.95	38.95
3546 6150	1 lb, 4.25" x 10.5", Ground Turkey	40.95	38.95
3546 2733	1 lb, 4.25" x 10.5", Pet Food	40.95	38.95

ITEM NO.	KEYHOLE DESIGN (NOT FOR SALE)	BOX	
		1-9	10+
3546 3001	1 lb, 4.25" x 10.5", Pork Sausage	\$40.95	\$38.95
3546 3002	2 lb, 4.25" x 13.5", Pork Sausage	42.95	40.95
3546 0016	2 lb, 5" x 11.25", Pork Sausage	42.95	40.95
3546 0012	1 lb, 4.25" x 10.5", Ground Pork	40.95	38.95
3546 4001	1 lb, 4.25" x 10.5", Ground Beef	40.95	38.95
3546 4002	2 lb, 4.25" x 13.5", Ground Beef	42.95	40.95
3546 0017	2 lb, 5" x 11.25", Ground Beef	42.95	40.95
3546 4005	5 lb, 6" x 18", Ground Beef	63.95	61.95
3546 5001	1 lb., 4.25" x 10.5", Wild Game	40.95	38.95
3546 5002	2 lb, 4.25" x 13.5", Wild Game	42.95	40.95
3546 1075	1 lb., 4.25 x 10.5", Camo Wild Game	40.95	38.95
3546 1399	2 lb, 4.5" x 13.5", Camo Wild Game	42.95	40.95

CLARITY™

E-Z PAK MEAT BAGS



SAFE HANDLING INSTRUCTIONS

Some food products may contain bacteria that could cause illness if the product is mishandled or cooked improperly. For your protection, follow these safe handling instructions.

- Keep refrigerated or frozen. Thaw in refrigerator or microwave.
- Keep raw meat and poultry separate from other foods. Wash working surfaces (including cutting boards), utensils, and hands after touching raw meat or poultry.
- Cook thoroughly. Cook to 165° F or higher.
- Keep hot foods hot. Refrigerate leftovers immediately or discard.

NFS

'Not For Sale' Safe Handling Label.

SAFE HANDLING INSTRUCTIONS

This product was prepared from inspected and approved meat and poultry. Some food products may contain bacteria that could cause illness if the product is mishandled or cooked improperly. For your protection, follow these safe handling instructions.

- Keep refrigerated or frozen. Thaw in refrigerator or microwave.
- Keep raw meat and poultry separate from other foods. Wash working surfaces (including cutting boards), utensils, and hands after touching raw meat or poultry.
- Cook thoroughly.
- Keep hot foods hot. Refrigerate leftovers immediately or discard.

Standard Safe Handling Label.



IN-STOCK POLY BAG DIMENSIONS

1 Pound: 4-1/2 inches W x 10-1/2 inches H
2 Pound: 5 inches W x 11-1/4 inches H
2 Pound: 4-1/2 inches W x 13-1/2 inches H
5 Pound: 6-1/2 inches W x 18 inches H
10 Pound: 8-1/2 inches W x 21 inches H

KEYHOLE DESIGN

White Bags with Stock Printed Colors:

- Pork Sausage and Ground Pork: blue
- Ground Beef: red
- Hot Italian Sausage: dark red
- Italian Sausage: green
- Ground Chicken: yellow
- Ground Turkey: orange
- Pet Food: purple
- Wild Game: black
- Camo Wild Game: tan/brown/green camo



Custom Poly Bags

- Set your product apart from the competition.
- Custom printed Clarity™ E-Z Pak Poly Meat Bags are available in a variety of sizes and types.
- We can accommodate virtually any size or type of Custom Poly Bags with various features and options.
- FREE standard shipping in the 48 contiguous states!

CLARITY™
E-Z PAK MEAT BAGS



CUSTOM KEYHOLE AND BARN STYLE BAGS

*in a variety of colors, gussets and thicknesses AVAILABLE AT STOCK BAG PRICING!
Minimums may apply.*



NOTE: Other custom poly bags vary on minimum order. CALL FOR MORE INFORMATION AND PRICING.

Custom Poly Bags

DESCRIPTION	BAG MINIMUM ORDER
A. Keyhole Design (White or Clear)	10,000
B. Camo Keyhole Design	10,000
C. Barn Design (White or Clear)	Call for Details
D. Full Custom Design (White or Clear)	Call for Details
E. Photo Meat Bags	Call for Details

THESE STANDARD NUTRITION LABELS ARE AVAILABLE ON CUSTOM GROUND BEEF BAGS AT NO ADDITIONAL COST.

Nutrition Facts	
Serving Size 4oz. (112 g) Servings Per Container Varied	
Amount per serving	
Calories 280	Calories From Fat 200
% Daily Value *	
Total Fat	22g 34%
Saturated Fat	9g 45%
Cholesterol	80mg 27%
Sodium	75mg 3%
Total Carbohydrate	0g 0%
Protein	19g
Iron 10%	
Not a significant source of dietary fiber, sugars, vitamin A, vitamin C and calcium.	
*Percent Daily Values are based on a 2,000 calorie diet.	

80/20

Nutrition Facts	
Serving Size 4oz. (112 g) Servings Per Container Varied	
Amount per serving	
Calories 240	Calories From Fat 150
% Daily Value *	
Total Fat	17g 26%
Saturated Fat	7g 35%
Cholesterol	75mg 25%
Sodium	75mg 3%
Total Carbohydrate	0g 0%
Protein	21g
Iron 15%	
Not a significant source of dietary fiber, sugars, vitamin A, vitamin C and calcium.	
*Percent Daily Values are based on a 2,000 calorie diet.	

85/15

Nutrition Facts	
Serving Size 4oz. (112 g) Servings Per Container Varied	
Amount per serving	
Calories 200	Calories From Fat 100
% Daily Value *	
Total Fat	11g 17%
Saturated Fat	4.5g 23%
Cholesterol	75mg 25%
Sodium	75mg 3%
Total Carbohydrate	0g 0%
Protein	22g
Iron 15%	
Not a significant source of dietary fiber, sugars, vitamin A, vitamin C and calcium.	
*Percent Daily Values are based on a 2,000 calorie diet.	

90/10

Shirred Meat Casings

132 feet of continuous casings — perfect for automated applications.

- Safe Handling Instructions repeated on each casing. • Thermo shrinkable. • PA/PE blend.
- Can be cooked at 90 °C/194 °F until desired internal temperature is reached.
- Can be frozen. • For raw or cooked meat. • **NOT** for smoking meats.
- Recommend soaking 20-30 minutes before use, but not required.
- Not For Sale.



Safe Handling Instructions repeated on casing A and B.

NOTE: Custom sizes and printing available. Call for more details.

ITEM NO.	PRODUCT	SIZE	COLOR	EACH SHIRR	
				1-39	40+
F263 00681	A. Pork Sausage, Not For Sale	65mm x 132'	Blue	\$21.45	\$19.95
F263 00691	B. Ground Beef, Not For Sale	65mm x 132'	Red	21.45	19.95
F263 00671	C. Wild Game, Not For Sale	65mm x 132'	Camo	21.45	19.95
F263 00831	D. Unprinted	65mm x 132'	Clear	18.86	---
F263 00841	E. Unprinted	65mm x 132'	White	20.37	---

▶ 40 SHIRRS PER CASE.

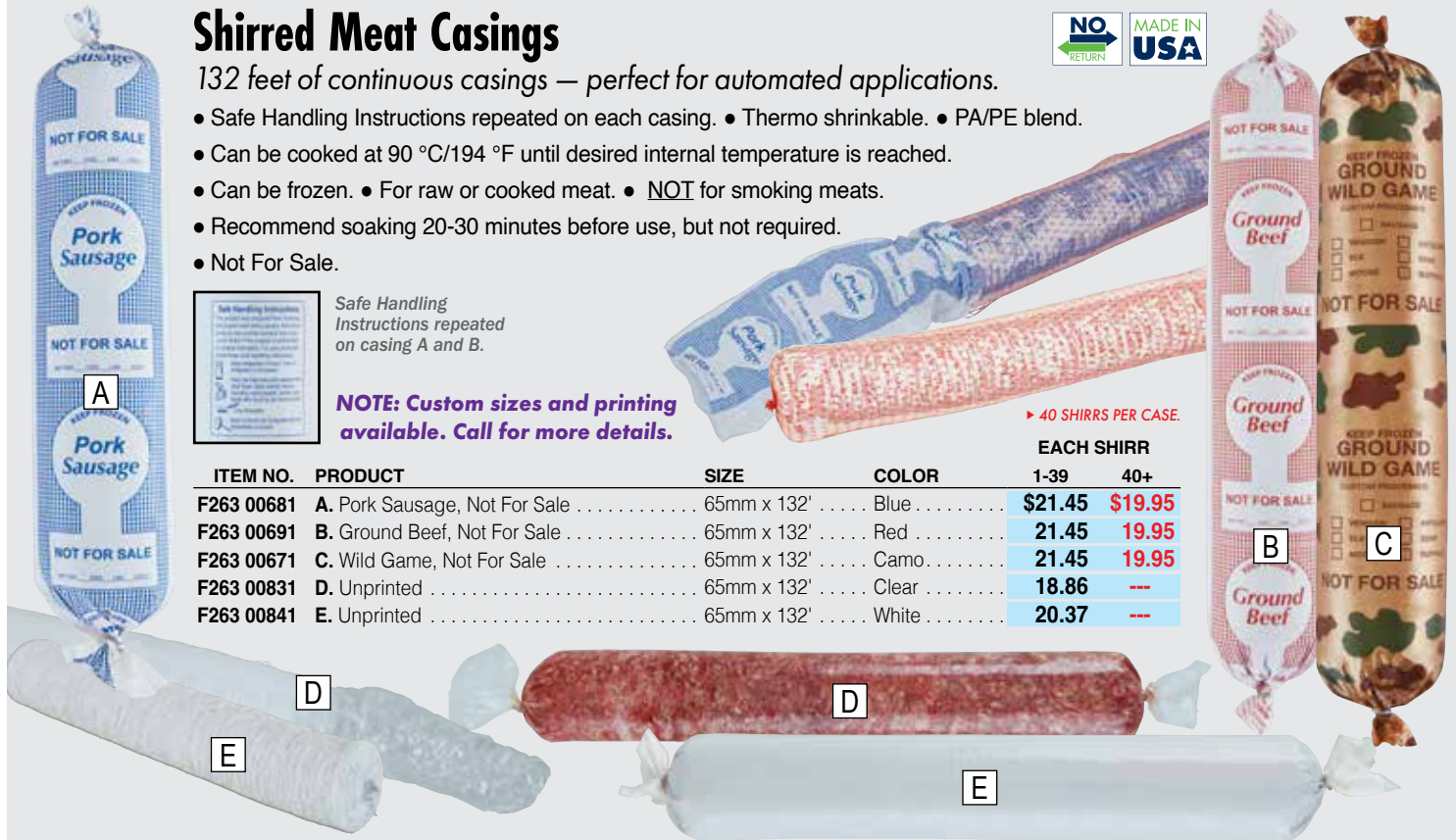

Clear Tubing Rolls, 3 Mil

▶ 30 ROLLS PER CASE.

ITEM NO.	PRODUCT	SIZE	ROLL
F263 00881	4" Tubing Roll	4" x 2,000"	\$82.70
F263 00871	6" Tubing Roll	4" x 2,000"	119.41
F263 00861	8" Tubing Roll	4" x 2,000"	159.23



Poly Bag Clipper

Manually, hermetically clips poly bags.

- Standard aluminum clips are easily re-loaded in top mounted magazine.
- Includes clamps for quick set-up and breakdown.
- Creates a perfect hermetic seal without ever contacting bag contents.



ITEM NO.	PRODUCT	EACH
6213 30801	Poly Bag Clipper	\$759.00
6213 07115	1/2" x 7/16" Clips (2,000/Box)	20.95
6213 07135	1/2" x 9/16" Clips (2,000/Box)	33.95



Poly Bag Clipper Replacement Parts

ITEM NO.	PRODUCT	EACH
6213 4415	Clincher Holder	\$59.95
6213 4416	Clincher	7.95
6213 4417	Shaft Pin for Handle	8.95
6213 4418	Lock Washer	0.95
6213 4419	Nut	0.95
6213 4420	Magazine Unit	69.95



Accessories included.



Stainless Steel Bag Taping Machine

Closes bag and cuts tape in one easy motion.

- Uses no electricity.
- Wipes clean with a damp cloth.
- Uses less than 2 inches of tape with each seal.



ITEM NO.	PRODUCT	EACH
6627 54951	Stainless Steel Bag Taping Machine.....	\$39.95

Plastic Tape

- Over 3,000 seals per roll.
- 3/8 inch x 180 yards per roll.

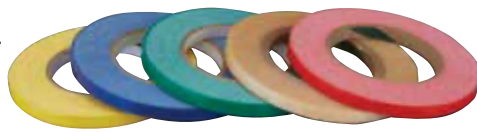

▶ 12 PER CASE.

ITEM NO.	PRODUCT	EACH	
		1-11	12+
3105 00451	Yellow	\$4.95	\$4.45
3105 00441	Dark Blue.....	4.95	4.45
3105 00431	Green.....	4.95	4.45
3105 00461	Clear.....	4.95	4.45
3105 00421	Red.....	4.95	4.45

Taping Machine Replacement Parts

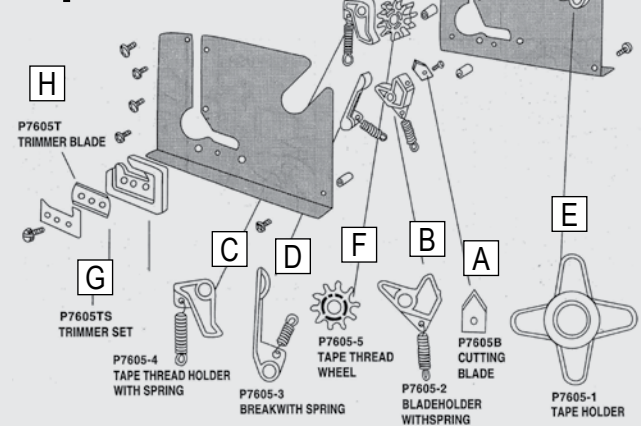

ITEM NO.	PRODUCT	EACH
6627 91791	A. Replacement Blade	\$5.20
6627 60521	B. Blade Holder.....	5.20
6627 60541	C. Tape Thread Holder	9.40
6627 60531	D. Breaker	7.30
6627 60511	E. Tape Holder	9.40
6627 60551	F. Tape Thread Wheel	9.40
6627 76071	G. Trimmer Set	10.45
6627 7605	H. Trimmer Blade	5.20

Hand-Held Bag Stapler

An economical alternative to the more expensive clipping systems.

- Special bag-sealing throat plate assures a tight seal with every staple (2-5/8 inch throat depth).
- Rust- and water-resistant chrome finish wipes clean with a damp cloth.



ITEM NO.	PRODUCT	EACH
6213 06941	Hand-Held Bag Stapler.....	\$39.95
6213 19105	3/8" Staples, 5,000/Box.....	8.95
6213 19125	1/2" Staples, 5,000/Box.....	9.95

Manual Clipper

One-step clipping for a variety of food products such as beef, poultry and cheese.

- Easy-to-operate manual, horizontal clipper.
- Small in size and versatile, making it ideal for closing various types of bags and netting, especially when the number of packages does not warrant a large or expensive machine.
- Constructed of rust-proof stainless steel.
- Includes convenient bag cut off.
- Dimensions: 21 inches x 13 inches x 16-1/5 inches.

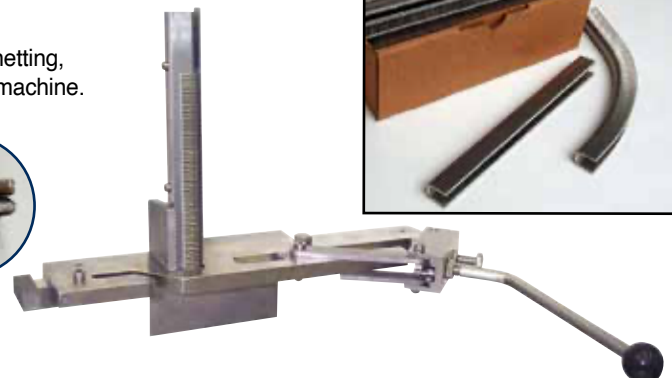

ITEM NO.	PRODUCT	EACH
E179 14001	Manual Clipper	\$5,312.69
E179 2411	Aluminum Clips (25,000/Case)	953.72

Locker Paper

- FDA approved for direct food handling.
- Consistent polyethylene coating helps lock in moisture.
- Prevents freezer burn. • Retains strength when wet.
- Core: 3 inches.



Light Weight

Locks out freezer burn up to 6 months.

ITEM NO.	PRODUCT	ROLL	
		1-19	20+
3053 02701	15" x 1,100 ft.....	\$54.06	\$49.06
3053 02711	18" x 1,100 ft.....	66.06	61.06
3053 02761	24" x 1,100 ft.....	87.08	82.08

Medium Weight

Locks out freezer burn up to 9 months.

ITEM NO.	PRODUCT	ROLL	
		1-19	20+
3053 02721	15" x 1,100 ft.....	\$61.74	\$56.74
3053 02731	18" x 1,100 ft.....	74.08	69.08
3053 02741	24" x 1,100 ft.....	98.76	93.76

Heavy Weight

Locks out freezer burn up to 12 months.

ITEM NO.	PRODUCT	ROLL	
		1-19	20+
3053 02661	15" x 1,000 ft.....	\$69.60	\$64.60
3053 02751	18" x 1,000 ft.....	83.52	78.52

"Safe Handling" Freezer Paper

Comply with safe handling requirements with stock printed freezer paper.

- Prevents freezer burn for up to 6 months.
- Ample free space to stamp.
- Eliminates the need for labels.
- Polyethylene coated, pinhole free, heat sealable.
- Repeating USDA approved safe handling message.
- Shipped in sanitary corrugated cardboard containers.

For Safe Handling Labels ▶ SEE PAGE 499



ITEM NO.	PRODUCT	ROLL	
		1-19	20+
1500 1621	18" x 1,000 ft.....	\$96.07	\$79.05

Camo Print Locker Paper

LOCKS OUT freezer burn up to 9 months.

- Polyethylene coated to help lock in moisture.



ITEM NO.	PRODUCT	ROLL	
		1-19	20+
1090 9217	18" x 600 ft.....	\$64.15	\$53.88

Double Roll Paper Cutter

- Holds 2 rolls of paper up to 18 inch width and 9 inches in diameter.
- Durable tubular steel construction. • Non-serrated blade.
- Finished in a gray baked powder coat.
- Easily assembled — ships knocked down.
- Dimensions: 22-1/2 inches W x 27-1/2 inches H x 18 inches D.



NOTE: Other sizes available. Call for more details.



NOTE: Paper sold separately, SEE ABOVE.

ITEM NO.	PRODUCT	EACH
2330 03671	Double Paper Cutter	\$164.45

Butcher Paper Cutter

- Welded steel construction.
- Holds up to 9 inch diameter rolls with universal mounting.

NOTE: Paper sold separately, SEE ABOVE.



ITEM NO.	PRODUCT	DIMENSIONS	EACH
1695 1515	15" Paper Cutter	17-1/2" x 5" x 12"	\$143.09
1695 0862	18" Paper Cutter	19-1/2" x 5" x 12"	147.64
1695 1024	24" Paper Cutter	26-1/2" x 5" x 12"	155.39
1695 0100	30" Paper Cutter	32-1/2" x 5" x 12"	155.39
1695 1036	36" Paper Cutter	38-1/2" x 5" x 12"	155.39

Industrial Strength Masking Tape

- Non-staining tape can be used in temperatures from 50 °F - 180 °F.
- Utility grade masking tape designed for routine packaging, sealing and labeling.
- Core diameter: 3 inches.

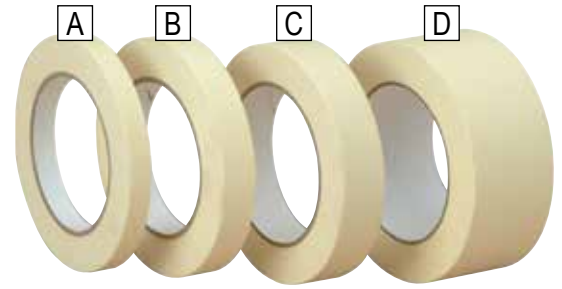

NOTE: Not Intended for Freezer Use.

ITEM NO.	PRODUCT	EACH
3957 72211	A. 1/2" x 180', 12 mm (72/Case)	\$1.95
3957 72171	B. 3/4" x 180', 18 mm (48/Case)	2.85
3957 72021	C. 1" x 180', 24 mm (36/Case)	3.25
3957 72011	D. 2" x 180', 48 mm (24/Case)	5.65

Multiple Roll Tape Dispensers

Easily dispense multiple rolls of tape from one convenient location.

- Dispenser has screw holes so that it can be securely mounted to tabletop. (Mounting hardware not included).
- Available in two sizes: Smaller dispenser holds any combination of tapes up to 4 inches wide. Larger dispenser holds up to 6 inches wide.

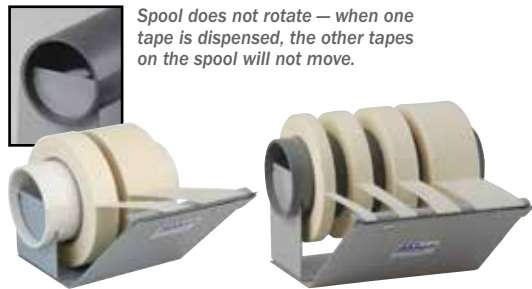

ITEM NO.	PRODUCT	EACH
2330 74041	4" Dispenser	\$69.25
2330 74061	6" Dispenser	78.70

Cold Temperature Tape



Super strong adhesive for wet and cold temperatures.

- Sticks in cold, wet applications.
- 3/4 inch x 180 foot, 18 mm x 55 mm.
- Core diameter: 3 inches.



▶ 48 PER CASE.

ITEM NO.	PRODUCT	EACH
6655 55931	Cold Temp. Tape	\$4.81

Scotch® Clear, Low-Temp Freezer Tape



- Suitable for hard to stick surfaces including cold, damp environments with temperatures down to -20 °F.
- Meets FDA guidelines for indirect food contact.
- Core diameter: 3 inches.
- Width: 48 mm (approx. 2 inches).
- Length: 100 m (approx. 110 yards).



▶ 36 PER CASE.

ITEM NO.	PRODUCT	EACH
6655 61801	2.3 Mil	\$6.55

Lever Operated GSO Tape Dispenser

- Automatic cutting tape dispense handles up to 500-foot rolls of 35-pound GSO tape up to 1-1/2 inches wide.



ITEM NO.	PRODUCT	EACH
3105 0348	Automatic Tape Dispenser	\$271.60

White GSO Tape



- Core Diameter: 1-1/4 inches. • Length: 500 feet.
- Available in Preprinted: "Thank You", "Safe Handling", "Not For Sale" or plain white.

NOTE: Custom printing available (minimum 6 case order). CALL FOR DETAILS.

1-Inch Tape

▶ 30 ROLLS PER CASE.

ITEM NO.	PRODUCT	EACH
3957 41911	"Thank You"	\$6.75
3957 41901	"Not for Sale"	6.75
3957 00511	White, Not Printed	6.75



1-1/2-Inch Tape

▶ 20 ROLLS PER CASE.

ITEM NO.	PRODUCT	EACH
3957 20361	"Safe Handling"	\$7.85
3957 20371	White, Not Printed	6.75

Poly Wrapping Film and Film Cutter

- All steel welded construction.
- Serrated blade.
- Holds 9 inch diameter rolls with universal mounting.
- Dimensions: 12 inches H x 5 inches D.

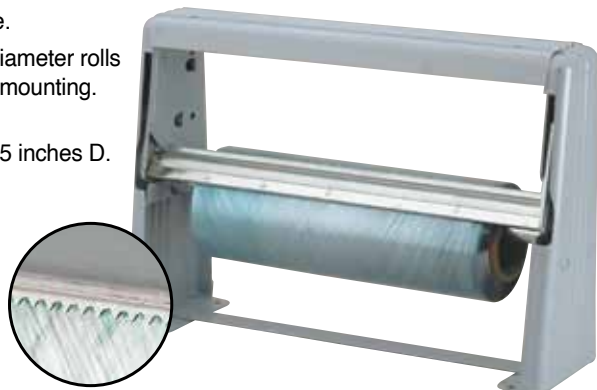

ITEM NO.	PRODUCT	DIMENSIONS	EACH
1695 1015	15" Film Cutter	17-1/2" x 5" x 12"	\$173.55
1695 1018	18" Film Cutter	19-1/2" x 5" x 12"	173.66
1695 2224	24" Film Cutter	26-1/2" x 5" x 12"	181.72
3546 0019	1 Mil Poly Film Roll	18" x 4,400'	104.92

PVC Wrapping Film

Superior strength, stretch and clarity.

- 60 gauge. • Clear.



**CALL 800-456-5624
for pallet pricing.**



► 1 ROLL PER CARTON.

ITEM NO.	SIZE	EACH	
		1-3	4+
7500 3813	15" x 5,000'	\$254.78	\$247.43
7500 3815	18" x 5,000'	260.35	255.35

PVC Film Wrapper

- Constructed from aluminum and stainless steel.
- Teflon covered 6-inch x 15-inch hot plate prevents sticking.
- Sanitary, easily maintained and quality control inspected.
- UL listed. 115 V. • Maximum width: 20 inches.
- 24 inches L x 22-1/4 inches W x 5 inches H.

NOTE: Replacement parts available. SEE BELOW.



ITEM NO.	PRODUCT	EACH
3821 0030	PVC Film Wrapper	\$616.25

Film Wrapper Replacement Parts

ITEM NO.	PRODUCT	EACH
3821 0047	A. Thermostat Knob	\$5.52
3821 1013	B. Fuse Holder	14.52
3821 10341	C. Fuse Lamp	13.19
3821 0057	D. Thermostat	76.67
3821 7305	E. Cut-Off Rod	196.17
3821 8805	F. Heating Element	32.22
3821 7310	G. Circuit Board	114.26
3821 7010	Teflon Cover (Not Pictured)	32.50
3821 60041	Pilot Light, Red (Not Pictured)	14.03
3821 20081	Toggle Switch (Not Pictured)	15.28
3821 0006	Hot Plate Kit (Not Pictured)	218.42

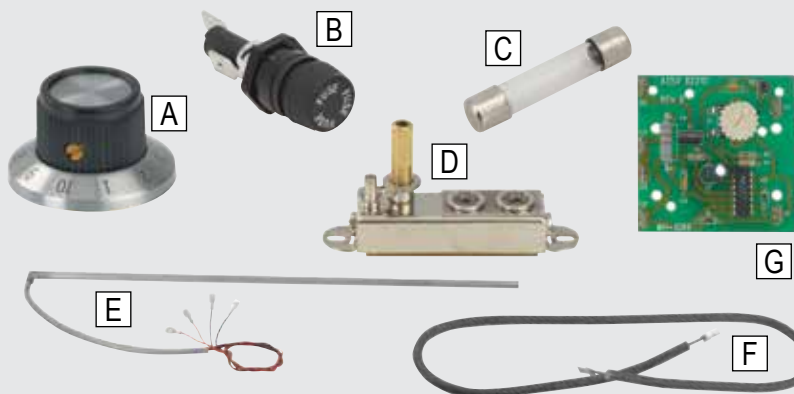

Reversible Soaker Pads

- Absorbs and retains exudates that drain from meat or poultry under everyday conditions of packaging, storage and handling.
- Works face up or face down for no-hassle placement into trays.
- Makes for a cleaner, more hygienic package.



ITEM NO.	SIZE	QUANTITY	CASE
H473 0067	5-2/5" x 6-1/2"	3,000/Case	\$89.00
H473 0077	4" x 6-1/2"	2,600/Case	94.80

OxyFree™ Oxygen Absorbers

Preserve freshness and extend the shelf life of packaged foods like jerky!



- General purpose iron-based absorbers. Absorbs both O₂ and CO₂.
- Prevents spoilage, microbe development and oxidative deterioration during an extended shelf life.
- Removes over 99.9% of oxygen from sealed, airtight packages.
- Shape: rectangular loose sachet.



▶ SEE PAGE 479
Zipper Pouches
Sold Separately



ITEM NO.	PRODUCT	BAG
G242 04305	Gram Weight: 1.2 +/- 0.1, 30cc (200/Bag)	\$4.95
G242 04505	Gram Weight: 1.8 +/- 0.1, 50cc (200/Bag)	5.95
G242 41005	Gram Weight: 3.1 +/- 0.1, 100cc (100/Bag)	3.95

Foam Trays

- Available in convenient sizes and colors.



CALL 800-456-5624 for pallet pricing.

ITEM NO.	PRODUCT	SIZE	QUANTITY	CASE
1620 0569	1,000/Case	8-1/2" x 4-1/2"	1,000/Case	\$95.62
1620 0548	500/Case	8" x 5-3/4" x 3/4"	500/Case	87.95
1620 1792	300/Case	6-3/4" x 9"	300/Case	116.44

Safe Handling Labels



- Available in black, blue or red text.
- Size: 1-1/2 inches x 2 inches.
- Pressure sensitive adhesive label stick to most packaging films and paper products.



NOTE: Labels shown are NOT true to actual size.

▶ 1,000 LABELS PER ROLL

ITEM NO.	COLOR	ROLL
3105 00031	Blue	\$10.92
3105 00041	Red	10.92
3105 00051	Black	10.92

Viper® PRO Multi-Purpose Tool



Replace the need for multiple unsafe tools in the workplace such as scissors, utility knives and box cutters.

- Minimizes cross-contamination, which causes foodborne illness.
- Reduces injuries due to loose blades and other unsafe tools in the workplace.
- Reduces food product damage and contamination.
- Stainless steel blade resists corrosion and breakage.
- FDA compliant, food-safe materials.
- One tool for multiple applications.
- High visibility color.
- Ergonomically designed for ease of use.
- Easy to clean, dishwasher and sanitizer safe.



▶ 6 PER BOX.

ITEM NO.	PRODUCT	BOX
1156 00055	Viper® PRO Multi-Purpose Tool	\$35.08

Viper® Safety Bag and Pouch Opener



Reduce cross-contamination when opening bags or packages of food and protect the user against laceration injuries.

- Minimizes cross-contamination, which causes foodborne illness.
- Reduces injuries associated with loose blades in the workplace.
- Stainless steel blade resists corrosion and breakage.
- Reduces food product damage and contamination.
- Easy to clean, dishwasher and sanitizer safe.
- Ergonomically designed for ease of use.
- FDA compliant, food-safe materials.



▶ 6 PER BOX.

ITEM NO.	PRODUCT	EACH
1156 21011	Viper® Safety Bag and Pouch Opener	\$3.95

SHOP 24/7
bunzlpd.com



Need Help?
 Chat With Us
 Online!

STAY CONNECTED WITH US:



Where you can find out what's on sale, find updated product information, reviews and pricing.





Shrink Film

This multilayered film is versatile enough to perform on all sealing systems and shrink tunnels. The premium resin formulation provides our strongest seals and offers a high shrink force, making it an ideal choice for multi packing and unitizing product.

- Wide window of operation — Performs across a complete range of applications and equipment. Ideal for older equipment.
- Crosslinked technology — Provides consistent sealing and shrinking at a broader range of temperatures.
- Superior sealing performance — On all types of equipment and sealing technology. Yields cleaner, stronger seals eliminating blowouts. Save time and money on expensive rewraps.
 - Higher shrink force — Ensures greater package integrity for multi-pack applications.
 - FDA compliant — for direct food contact. • Printable — For enhanced marketing opportunities.
 - Fully recyclable.



ITEM NO.	PRODUCT	GAUGE	ROLL	
			1-2	3+
3957 1400	14" x 4,375' Center Fold	.60	\$260.85	\$250.85
3957 1801	18" x 4,375' Center Fold	.60	297.65	287.65
3957 1601	16" x 3,500' Center Fold	.75	297.65	287.65
3957 1802	18" x 3,500' Center Fold	.75	319.95	309.95



CLARITY™

LOW-DENSITY POLY BAGS



Low-Density Poly Food Bags

- Constructed of linear, low-density polyethylene.
- Available in regular or heavy gauge. • Provides excellent clarity of product.
- FDA compliant.

► SEE PAGE 502
Twist Ties Sold Separately

Regular Gauge

ITEM NO.	PRODUCT	SIZE	QTY.	CASE
3899 0916	Clear 0.70 Mil, Non-Vented	6" x 15"	1,000/Case	\$53.15
3899 0475	Clear 0.75 Mil, Non-Vented	8" x 15"	1,000/Case	60.25

Heavy Gauge

ITEM NO.	PRODUCT	SIZE	QTY.	CASE
7600 0665	Clear 1.00 Mil	8" x 15"	1,000/Case	\$90.20
7600 0208	Clear .90 Mil	8" x 18"	1,000/Case	55.00
7600 0435	Clear 1.25 Mil	12" x 24"	500/Case	105.60



Butcher Twine

- Breaking strengths:
12-ply: 30 pounds
24-ply: 60 pounds
30-ply: 75 pounds



► 25 CONES PER CASE.

ITEM NO.	PRODUCT	EACH
7500 02001	12-ply, 3,600 ft.	\$12.02
7500 02091	24-ply, 1,680 ft.	12.02
7500 02131	30-ply, 1,344 ft.	12.02

Twine Dispenser

Dispense twine without unraveling.

- Dispenses twine, does not cut twine.



Built-in spring plunger keeps twine secure by preventing spinning.

NOTE: Purchase twine knives separately.



ITEM NO.	PRODUCT	EACH
2330 10081	Twine Dispenser	\$34.60

Wrapping Film and Dispenser with Cutting Edge



- Crystal clear PVC wrapping film packaged in convenient and portable film dispenser.
- Dispenser has metal blade/bar for easy and precise cutting of film.



► 4 PER CASE.

ITEM NO.	PRODUCT	EACH
7500 3821	12" x 2,000'	\$40.09
7500 3831	18" x 2,000'	75.20

White Twist Ties

Ideal for closing poly meat and food bags.

- Paper and wire construction. • Length: 4 inches.



► 2,000 PER BOX.

ITEM NO.	PRODUCT	BOX
3490 03915	White Twist Ties.	\$6.85

Plastic White Bag Clips

Ideal for closing poly meat and food bags.

- Heavy-duty closures contain up to 10 pounds of weight.



NOTE: Other colors and sizes available. Call for details.

► 3,500 PER PACK.

ITEM NO.	PRODUCT	PACK
4235 30025	Plastic White Bag Clips.	\$50.02

SHOP
bunzlpd.com
24/7



Need Help?
Chat With Us Online!

STAY CONNECTED WITH US:



Patty Paper

- Dry wax treated for moisture resistancy and easy release.
- Sheets are easy to access and dispense one at a time.
- FDA and USDA compliant.



▶ 1,000 PER BOX - 24 BOXES PER CASE.

ITEM NO.	PRODUCT	SIZE	BOX
1640 00265	Patty Paper	.5-1/2" x 5-1/2"	\$13.98

Satin-Pac® Deli Paper

- Poly film provides barrier to contain wetness.
- Ideal freezer interleaver, deli pickup sheet or weighing scale sheet.
- Handy dispenser box packaging, interfolded for easy one-at-a-time dispensing.



▶ 1,000 PER BOX - 10 BOXES PER CASE.

ITEM NO.	PRODUCT	SIZE	BOX
1500 49205	Deli Paper	8" x 10-3/4"	\$15.82

Deli Paper

- Light-weight interfold deli sheet dispenses easily.
- Dry waxed coating strips clean from meats, cheese and other deli foods.



▶ 500 PER BOX - 12 BOXES PER CASE.

ITEM NO.	PRODUCT	BOX
1570 00061	8" x 10-3/4"	\$10.65
1570 00081	10" x 10-3/4"	14.85
1570 00161	12" x 10-3/4"	15.85

Roll

ITEM NO.	PRODUCT	EACH
7500 2050	18" x 500'	\$123.44



Platter Liners

Handles high heat with great release!



- Allows complete release from platters.
- Interleaved for serving and storage.
- FDA compliant.



▶ 1,000 PER CASE.

ITEM NO.	PRODUCT	SIZE	CASE
7500 3991	Platter Liner Sheets	16-2/5" x 24-2/5"	\$128.21

Steak Paper

- Colored paper enhances presentation of meat in display cases.
- Helps maintain the meat's color, moisture and freshness longer.
- Meat doesn't stick to the treated paper.
- USDA and FDA compliant.
- No wax coating added.
- Size: 9 inches x 12 inches.



▶ 1,000 PER CASE.

ITEM NO.	COLOR	CASE
1640 1912	Green	\$55.45
1640 0075	Black	73.85
1640 6902	Peach	52.95

Aluminum Foil Food Wrap

Ideal for schools, hospitals, hotels, restaurants, cafeterias and caterers. Perfect for storing freezing and cooking.



- Roll comes in a handy corrugated dispenser box for easy tearing.
- Sheets come in a pop-up dispenser box to get one sheet at a time.

Sheets

ITEM NO.	PRODUCT	CASE
7500 0950	9" x 10-3/4"	\$264.04



▶ 500 PER BOX - 6 BOXES PER CASE.

Ziploc® Sandwich Bags

- Small size store, protect and transport food easily.
- Features “grip strips” for easy handling with wet or greasy hands.
- Convenient self-dispensing bulk cartons.



ITEM NO.	PRODUCT	QTY.	CASE
3160 0121	Ziploc® Bags, Small, 6-1/2" x 5.9"	500/Case	\$45.95

Ziploc® Commercial Resealable Bags

- Both storage and freezer bags can be microwaved to reheat or defrost (should not be microwaved on high heat or used as a boil-in bag).
- Low-density polyethylene: 1.75 mil storage bags and 2.7 mil freezer bags.
- Write-on labels for content ID and date coding.
- Convenient self-dispensing bulk cartons.



Features “grip strips” for easy handling with wet or greasy hands.



ITEM NO.	PRODUCT	QTY.	CASE
3160 0125	A. Ziploc® Freezer Bags, Gallon, 10-1/2" x 11"	250/Case	\$71.62
3160 0120	Ziploc® Freezer Bags 2 Gallon, 15-1/2" x 13"	100/Case	78.48
3160 0123	B. Ziploc® Bags, Quart, 7" x 8"	500/Case	58.95
3160 0124	Ziploc® Bags, Gallon, 10-1/2" x 11"	250/Case	58.77
3160 0119	Ziploc® Bags, 2 Gallon, 15-1/2" x 13"	100/Case	62.92

Moisture-Resistant Food Trays/Meat Boats

- Heavy-duty coating gives incredible cut, grease and moisture resistance.
- Suitable for weighing and for serving hot or cold foods.

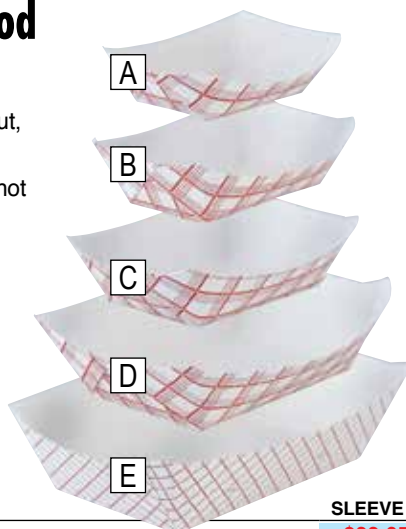

▶ 250 TRAYS PER SLEEVE.

ITEM NO.	PRODUCT	SLEEVE
6472 00275	A. 1/2 lb (4 Sleeves/Case)	\$22.65
6472 18765	B. 1 lb (4 Sleeves/Case)	19.55
6472 02005	C. 2 lb (4 Sleeves/Case)	28.50
6472 03005	D. 3 lb (2 Sleeves/Case)	90.30
1500 52255	E. 5 lb (2 Sleeves/Case)	79.42

Deli "SlideLock" Bags

Easy to use with a secure reclosable "slidelock" closure.



- Saddle pack dispensing — easy to reach and easy to use.
- Preferred by both customers and store personnel alike.
- Leak and odor resistant.



NOTE: Custom prints available.

▶ 50 BAGS PER HEADER - 20 HEADERS PER CASE.

ITEM NO.	PRODUCT	SIZE	CASE
7500 1302	Deli Bags, 2-Color	10" x 8"	\$107.95

Deli Cups



- Highly resistant to fats and oils.
- Gullet lids available in clear only.
- Withstands refrigeration and microwave temperatures and are dishwasher safe.
- Polypropylene containers are strong and reusable.



▶ 250 CONTAINERS AND LIDS PER CASE.

ITEM NO.	PRODUCT	CASE
1080 3032	A. 8 oz. Clear Cup w/Lid	\$120.86
7500 2456	B. 16 oz. Clear Cup w/Lid	130.25
7500 2457	C. 16 oz. White Cup w/Lid	204.25

Brown Paper Sacks

Back to the basics with biodegradable paper sacks!

- Strong paper sacks are perfect for grocery industry.



Call 800-456-5624 for pallet pricing.



► 500 PER BUNDLE.

ITEM NO.	PRODUCT	SIZE	BUNDLE
1320 0059	57# Brown Paper Sacks	12" x 7" x 17"	\$103.79

T-Sacks and T-Racks

Multi-purpose plastic bags are perfect for wet or frozen product.

- Sturdy metal T-rack is designed to house multiple T-sacks and hold individual sacks open for easy filling.
- T-rack constructed of polished metal with white poly base.
- White T-sacks are constructed of strong plastic to carry heavy loads without breaking, splitting or puncturing.



► 1,000 PER CASE.

ITEM NO.	PRODUCT	SIZE	CASE
1006 0002	T-Sacks w/Red Print	11-1/2" x 6-1/2" x 21"	\$48.95

ITEM NO.	PRODUCT	EACH
1830 28681	T-Rack	\$54.40

Shopping Baskets

Molded plastic will not rust or dent and are easy to clean.

- No more wire handles that pinch and hurt your hands when basket is full.
- BASKETS WILL NOT JAM. • Removable handles fold down to nest.
- Made from 100% recycled materials.
- Color: red with black handles.



ITEM NO.	PRODUCT	SIZE	EACH
2978 04151	Standard, 30 lb Capacity	17" x 12" x 9"	\$36.41

Paper Cone Cups

- The ideal cup for on-the-go environments.



► 5,000 PER CASE.

ITEM NO.	PRODUCT	CASE
1820 8203	4 oz. Cups	\$159.75

Nordic Ice Temperature Control Packs

Packs are reusable and non-toxic, stay frozen longer than ice. Economical to use.

- When packing, place gel pack on top of product. Leave as little dead space as possible.
- Biodegradable. • Freezes solid.

NOTE: Sold by case only.



► 36 PER CASE.

ITEM NO.	PRODUCT	CASE
C928 1016	16 oz., 6-1/2" x 5-1/2" x 1" (36/Case)	\$33.05
C928 1024	24 oz., 8" x 5-1/2" x 1-1/4" (24/Case)	29.05
C928 1048	48 oz., 10-1/2" x 7-1/2" x 1-1/4" (12/Case)	31.30

TALLY COUNTER

0 to 9999 with the click of your thumb.



**Distractions happen.
Don't lose track.**

▶ **SEE PAGE 510**

QUALITY CONTROL

FIND IT FAST

Metal Detectable Markers and Pens	508
Clipboards	509
Calculator	509
Stopwatches and Timers	510
Tally Counter	510
E. Coli Sampling Kit	511
Leak Checker	511
Whirl-Pak® Bags	511
OXYBABY® Gas Analyzer	512
Test Strips/Test Kits	512
Fat Analyzer	513
pH Meter	513



METAL DETECTABLE PRODUCTS

All Stainless Steel Retractable Ballpoint Pen

The heavy-duty stainless-steel barrel with a knurled grip ensures superior writing stability. Rugged and sturdy, this ballpoint pen can take a beating and is ideal for factory environment.

- Durable stainless steel is metal detectable – tip, barrel, clip.
- Secure knurled grip.
- Silent retractable plunger.



ZEBRA

All Stainless Steel Black Refill

The steel ballpoint uses smooth, easy-glide ink for a more controlled writing experience.

- Premium all-metal refill is easily metal detectable making it ideal for factory settings.
- Effortless refill process makes it great for everyday use.



ITEM NO.	PRODUCT	EACH
M268 00011	All Metal Stainless Steel Retractable Pen . . .	\$7.95

ITEM NO.	PRODUCT	EACH
M268 00021	All Metal Stainless Steel Refill, 0.8mm Black. . . .	\$2.95

Permanent Markers

- Permanent marker has a blue, metal detectable body.
- Marker available with black permanent ink.
- Removable cap fits snugly onto base of marker.
- Non-toxic, xylene-free, low-odor.



► 10 MARKERS PER BOX.

ITEM NO.	PRODUCT	BOX
B639 3900	Black Ink	\$67.95

Stick Pen

- Pen body is constructed from a polypropylene mix, containing a non-toxic, metal-detectable additive.
- Body is shatterproof and will not splinter into small segments.
- Available with or without a clip.

NOTE: Stick pens are also available with red bodies, and with green or red ink. CALL FOR MORE DETAILS.



Available with a convenient pocket clip.

► 50 PENS PER BOX.

ITEM NO.	PRODUCT	BOX
B639 39055	A. Blue Body, Blue Ink w/o Clip	\$80.95
B639 76855	B. Blue Body, Blue Ink w/Clip	77.95

Metal Detectable Retractable, Pressurized Pen

For use in cold environment applications only, even the freezer.

- Pen body is constructed from a polypropylene mix, containing a non-toxic, metal-detectable additive.
- Body is shatterproof and will not splinter into small segments.
- Pressurized ink cartridge for smooth ink flow.
- Available in blue, green, and red body colors for ease in color-coding work spaces to prevent cross-contamination.



Pen retracts with the push of a button.



"P" on cap indicates pressurized.



ITEM NO.	PRODUCT
B639 22015	Blue Body, Black Ink
B639 22045	Red Body, Black Ink
B639 22055	Green Body, Black Ink
B639 22005	Blue Body, Blue Ink
B639 22025	Red Body, Blue Ink
B639 22035	Green Body, Blue Ink

► 25 PENS PER BOX.

BOX
\$239.95

Aluminum Covered Clipboard

- Powerful clip holds approximately fifty, 8-1/2-inch x 12-inch three-part forms.



Storage compartment holds thirty, three-part forms.

▶ 12 PER CASE.

ITEM NO.	PRODUCT	EACH
3845 51671	Aluminum Clipboard	\$34.45

Plastic Clipboard

- Holds standard 8-1/2-inch x 11-inch paper.
- Heavy-duty clip.
- 1/8-inch thick plastic.



▶ 12 PER CASE.

ITEM NO.	PRODUCT	EACH
3548 16031	Plastic Clipboard	\$10.30

Hand-Held Solar Calculator

- Features the four basic arithmetic functions.
- Easy-to-read, eight-digit LCD display.
- Solar powered from any available light source.
- Comes with protective travel case.
- Overall size: 3 inches W x 5-1/2 inches H x 1/4 inches D.
- Includes G10 1.5 V back-up battery.



▶ 10 PER CASE.

ITEM NO.	PRODUCT	EACH
3304 21681	Solar Calculator	\$7.85

NEED ASSISTANCE?

Our experienced customer service representatives are available to answer your questions, find the products you are looking for, check product availability, as well as take your order.

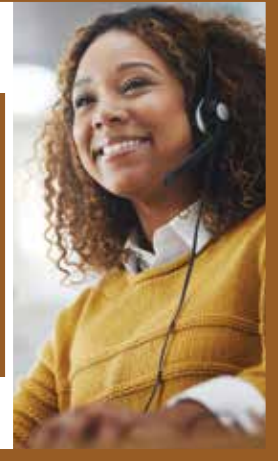

800-456-5624

METAL DETECTABLE PRODUCTS

For an added measure of safety around food processing areas.

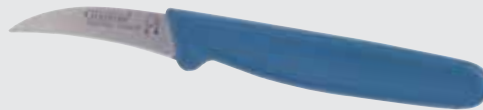

PRODUCT	PAGE
Drain Plug for Stainless Vats	▶ 219
Mixing Paddle Scraper	▶ 242
Shovels	▶ 246
Hand Scoops	▶ 248
Hand Scrapers	▶ 248
Bandages	▶ 282
Earplugs	▶ 307 - 308
Paring Knife	▶ 362

TFS4 Multi-Station Timer



Color-coded LED with distinctive beepers for each timer and coordinating key pad buttons.

- Keypad is grease resistant and splash-proof.
- Automatically counts up to 99 hours/59 minutes when time goes off.
- 4 different timer mode stations that can be used independently or simultaneously.
- Adjustable volume control that makes it easy to hear from across a large room - making it the ideal timer for noisy work environments.
- 4 distinctive alerts, 4 recall modes and 4 switchable minute/seconds or hours/minutes.
- Includes 4 C batteries.



► SEE PAGE 566
For Batteries

ITEM NO.	PRODUCT	EACH
3098 00151	TFS4 Timer	\$118.07

Tally Counter

- High-quality, low-cost counter that registers to 9999 and resets to zero.
- An easy click with thumb to advance.
- Chrome finish; curved to fit the hand.



ITEM NO.	PRODUCT	EACH
3244 0608	Tally Counter	\$14.95

Pro-Survivor Water-Resistant Stopwatch

- Stopwatch is designed with no-fail switches and is water-resistant.
- 24-hour range is displayed in 6 digits, so resolution goes from 1/100 second to 1 second after 30 minutes.
- Cumulative split function along with time, month, second and day of the week.
- Break-away neck strap included. • Water-resistant up to 160 feet.
- Includes one LR44 1.5 V battery.



ITEM NO.	COLOR
3244 46011	Blue
3244 36011	Red
3244 26011	Yellow
3244 16011	Green
3244 06011	Black

EACH
\$19.95

► SEE PAGE 566
For Batteries

Large Digit Countdown Timer

Large LCD display is ideal for reading countdown time from a distance.

- Counts up or down.
- Magnetic back and clip with stand.
- Set-point is automatically stored in memory.
- Large push-buttons for minutes, seconds and start/stop.
- Minutes displayed by two 3/4-inch digits and seconds are displayed by two 1/2-inch digits.
- Includes one AAA battery.



► SEE PAGE 509
For Aluminum Clipboard



► SEE PAGE 566
For Batteries

Magnetic back and clip with stand



► 6 PER CASE.

ITEM NO.	PRODUCT	EACH
A692 02641	Countdown Timer	\$16.28

Survivor Water-Resistant Stopwatch



- Cumulative split function and 1-2 fast finish capabilities.
- 24-hour range displays time, date and day of week.
- Programmable alarm. • Water-resistant to 30 feet.
- Available in black only.
- Breakaway lanyard included.



ITEM NO.	PRODUCT	EACH
3244 00051	Survivor Stopwatch	\$11.95



E. Coli Sampling Kit

Designed for sampling meat and turkey carcasses to test for the presence of *E. coli*.

- Contains a pair of sterile polyethylene gloves, 25 mL buffered peptone water (with expiration date marked on the box) a Whirl-Pak® "Speci-Sponge"® Bag, and two disposable sterile templates, one for meat carcasses and one for turkeys.
- Acquire sample by moistening the sponge with half of the peptone water, the carcass is swabbed with the sponge through the template in three places for meat carcasses and two places on turkeys. The sponge is then returned to the bag and the balance of the peptone water is added. The bag is closed and sent to the laboratory for testing.

▶ 25 KITS PER CASE.

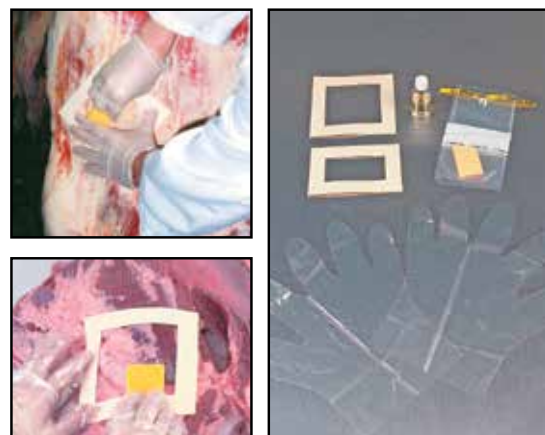

ITEM NO.	PRODUCT	THICKNESS	CASE
4220 1324	E. Coli Sampling Kit	2.5 Mil	\$281.45

Standard Bags

Sterile sample bags are used to take samples of liquids, semi-solids, or solids.

- Puncture-proof tabs are easier and safer to use than any other laboratory sample bag.
- Sterilized by ethylene oxide gas by an independent, ISO-Certified company.
- Documentation of sterility is available upon request.

Write-On Bags

Write-on strip makes sample identification easier and more convenient.

- The paper-like finish virtually eliminates ink smearing and provides a surface that will accept a variety of writing instruments. Ballpoint pen is recommended.
- Some also include approximate fill lines.

▶ 500 PER BOX.

ITEM NO.	PRODUCT	SIZE	THICKNESS	BOX
4220 1064	2 oz., Write-On	3" x 5"	2.25 Mil	\$113.75
4220 0679	4 oz., Standard	3" x 7-1/4"	2.25 Mil	114.75
4220 1062	4 oz., Write-On	3" x 7-1/4"	2.25 Mil	123.23
4220 0736	18 oz., Standard	4-1/2" x 9"	2.25 Mil	141.07
4220 1065	18 oz., Write-On	4-1/2" x 9"	2.25 Mil	164.63
4220 1018	13 oz., Standard	5-1/4" x 7-1/2"	3 Mil	180.59
4220 1020	24 oz., Standard	6" x 9"	3 Mil	182.87
4220 1297	24 oz., Write-On	6" x 9"	3 Mil	238.28
4220 0990	27 oz., Standard	5" x 12"	3 Mil	141.29
4220 0994	36 oz., Standard	5" x 15"	3 Mil	165.10
4220 1027	42 oz., Standard	6" x 15"	3 Mil	193.23
4220 1323	69 oz., Standard	7-1/2" x 15"	3 Mil	221.25
L171 0002	55 oz., Write-On	7-1/2" x 12"	4 Mil	254.53



WARNING: Bags should not be used at temperatures above 180 °F, 82 °C. Bags can be frozen to any temperature, even liquid nitrogen. Careful handling is required after freezing.

Guaranteed Sterile

Whirl-Pak® bags are not autoclavable. Whirl-Pak® bags are sterilized with ethylene oxide gas. Documentation of sterility is available upon request.

"Puncture Proof Tabs"

All Whirl-Pak® bags feature "Puncture Proof Tabs." This patented process extends the tape on the tab past the wire ends eliminating the sharp points which could puncture the bags, scratch a person's hand, or puncture gloves.

FDA Compliant

Resins used in the extrusion of film for Whirl-Pak® bags are FDA approved for food contact. Bags are manufactured in accordance with the requirements for manufacturers of single service containers for milk and milk products, as specified by the FDA.

Leak Checker

Use for modified atmosphere and vacuum packaging.

- Easily determines if there is a leak in your package due to a wrinkle in the seal area, a tear from the conveyor, or a puncture from a bone.

ITEM NO.	PRODUCT	EACH
B529 10111	A. Leak Checker Bulb	\$101.76
B529 10101	B. Leak Checker Injection Needle	56.68

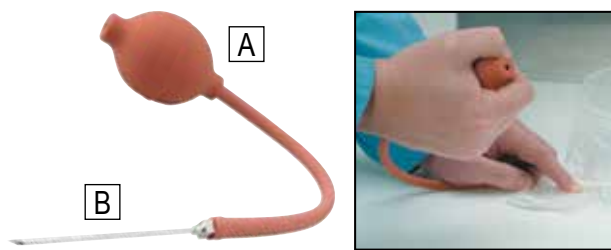

OXYBABY® Portable O₂ Gas Analyzer

Mobile handheld device can be used on-location for instant quality control of modified atmosphere packaging (MAP).

- Minimal sample gas requirement for smallest packs.
- Fast testing. Analysis in 6 seconds.
- Cordless operation using rechargeable batteries.
- Simple one hand operation.
- O₂ value is displayed in 0.01% steps.
- Long service-life of the oxygen sensor (approx. 2 years).
- Data log for 100 measurements. • Easy to clean.
- All information at a glance with the large illuminated graphic display.
- Multilingual menu guide with 14 language options.

Both Models Include:

- OXYBABY® M+I
- Charging Device and Power Supply
- CD-ROM with Operating Instructions
- (2) Spare Needles
- (2) Spare Filters
- 100 Rubber Seals
- Carrying Case
- Dimensions: 12-4/5 inches H x 15-1/5 inches W x 4-1/2 inches D
- Case weight: approx.1.7 kg



ITEM NO.	PRODUCT	MFR. NO.	EACH
J097 00011	OXYBABY® M+I for O2 w/Case and Accessories	5900003131	\$3,097.94
J097 00051	OXYBABY™ M+I for CO2/O2 w/Case and Accessories	5900003051	6,296.20
J097 00025	A. Replacement Needles (Pack of 15)		256.75
J097 00035	B. Septum Pad Rubber Seals (Sheet of 100)		64.21
J097 00045	C. Filters (Pack of 5)		117.65

Scan this QR code with your mobile device to watch a video about the OXYBABY®

QuattroSelect Quaternary Test Strips



For the simple, reliable and economical means to measure the concentration of Quaternary Sanitizers.

- Immerse with color matches at 0-100-200-300-400 ppm, the test strips detect the exhaustion of solutions – helping to determine which sanitizers should be replaced as well as those that have excessive amounts of sanitizing agents.
- Test results in only 10 seconds.
- 15-foot roll.



ITEM NO.	PRODUCT	EACH
G496 93991	Quaternary Test Strip, 15 ft. Roll	\$16.95

Chlorine Test Strips

One strip accurately tests the chlorine level of water and other solutions.

- Immerse one end of test strip into water, remove immediately and blot with a paper towel – then compare to enclosed color chart to determine chlorine level.



▶ 200 STRIPS PER BOTTLE.

ITEM NO.	PRODUCT	BOTTLE
3230 3425	Chlorine Test Strips	\$10.42

Oyster™ Series pH/mV Temperature Meter

Can be used in the lab or in the field.

- Measures: pH from 0 to 14.00 pH and is accurate to .02 pH mV from -999 mV to 999 mV and is accurate to 2 mV.
- Temperature: 32° to 212 °F (0 °C to 100 °C); Accuracy: to 0.8 °F (0.5 °C).
- Audible beeper to alert user when function is completed.
- 5 point buffer recognition (1.68, 4, 7, 10, 12.45) with adjustable buffer values.
- Microprocessor protected by a splash-proof housing.
- Memory function stores and recalls 25 labeled readings, including min./max.
- Self-diagnostic display codes help user troubleshoot electrode, buffer, and temperature errors.
- Includes one, 9 V battery.

► SEE PAGE 566
For Batteries



Kit includes:

- Mini pH Electrode
- Sample Buffers (4 and 7 pH)
- Neck Strap
- Carrying Case

Large LCD built into adjustable flip-up cover displays pH and temperature.

ITEM NO.	PRODUCT	EACH
3024 0015	Meter Kit	\$284.26
3024 0103	20/pk Buffers and Rinse Pouch	43.53
3024 6012	Mini pH Electrode	65.61
3024 1500	Standard pH Electrode	60.85
3024 0110	Flat Surface Electrode	152.20

Univex Ground Beef Fat Analyzer

Supermarket tested and proven to be the fastest, most accurate method of ground beef fat analysis.

- Requires only a three minute cycle time.
- Power: 115 V/60 Hz/single phase.
- Shipping weight: 12 pounds.



Kit includes:

- Case
- Measuring Device
- Meat Cartridge
- Heat Transformer
- (6) Vials
- Electric Cord



Scan this QR code with your mobile device to watch a demo video about the Univex Ground Beef Fat Analyzer

ITEM NO.	PRODUCT	DIMENSIONS	EACH
5081 5677	Univex Fat Analyzer w/Accessories	4" x 5-1/2" x 4"	\$1,285.25
5081 94691	Replacement Vials		5.15

Chlorine Test Kit

For the determination of chlorine solutions used in the sanitation of food processing areas and machinery.



Kit contents:

- Sodium Thiosulfate 0.0513N, 60 mL
- Potassium Iodide 5%, 60 mL
- Starch Indicator Solution 1%, 60 mL
- Sulfuric Acid 20%, 60 mL
- 50 mL Test Vial

ITEM NO.	PRODUCT	EACH
G496 97901	Chlorine Test Kit	\$71.95

Instructions and SDS Sheets

Cationic Test Kit

For the determination of cationic disinfectants used in the sanitation of food processing areas and machinery.



Kit contents:

- Hydrochloric Acid 10%, 60 mL
- Chrome Azurol 0.1%, 60 mL
- Dodecyl Sulfate 0.50%, 60 mL
- 50 mL Test Vial

ITEM NO.	PRODUCT	EACH
G496 98821	Cationic Test Kit	\$51.95

Instructions and SDS Sheets

A&D

A&D Weighing

Make it Legal for Trade with Stainless Steel Washdown Scales



► SEE PAGE 516

SCALES

FIND IT FAST

Digital Scales.....	516-519
Portion Control Scales	516, 518, 520
Washdown Safe Scales	516 - 517, 519
Bench Scales	519
Hanging Scales.....	519
Dial Scales.....	520
Calibration Weights	520
Scale Comparison Chart	521





Washdown Portion Control Scales

Yamato



- IP68 submersible in battery mode.
- IP65 washdown when using AC adapter.
- Under/Accept/Under checkweigh indicator. • Underside carrying handles.
- Complete stainless steel construction with large LCD display.
- Large removable stainless steel platform.
- Weighs in pounds, kilograms/ounces and pounds/ounces.
- Adjustable auto shut-off. • Battery or AC Operation.
- Four D batteries required, not included. ➔

NOTE: AC adapter INCLUDED.

For Batteries ▶ SEE PAGE 566

ITEM NO.	MODEL	CAPACITY	RESOLUTION LB/OZ.	EACH
4893 03211	PPC-300WP-II-4.4 4.4 lb	5 lb x 0.05 oz.	\$720.60
4893 30111	PPC-300WP-II-10. 10 lb.	10 lb x 0.1 oz.	720.60
4893 00211	PPC-300WP-II-22. 22 lb.	22 lb x 0.2 oz.	720.60
4893 00441	PPC-300WP-II-44. 44 lb.	44 lb x 0.5 oz.	720.60

Washdown Scales

Designed for use in the poultry, seafood and meat processing industries.

- IP65 washdown in battery mode. • Basic weighing, batch weighing, and over/under weighing.
- Portable, wireless design. • High degree of accuracy.
- Large, 9-inch x 9-inch removable stainless steel platform on a plastic housing.
- Initial, automatic, and semi-automatic zero-setting mechanisms.
- Adjustable auto shut-off to help conserve battery life.
- Weighs in pounds, pounds/ounces, ounces or kilograms.
- Six D batteries required, not included. ➔

Yamato

NOTE: AC adapter INCLUDED.

▶ SEE PAGE 566 For Batteries



ITEM NO.	MODEL	POUNDS (lb) CAPACITY/RESOLUTION	KILOGRAMS (kg) CAPACITY/RESOLUTION	EACH
4893 65551	PPC-200W-II-4. 4 lb/0.002 lb.	2kg/0.001kg.	\$516.50
4893 00411	PPC-200W-II-10. 10 lb/0.005 lb.	4kg/0.002kg.	516.50
4893 00391	PPC-200W-II-20. 20 lb/0.01 lb.	10kg/0.005kg.	516.50
4893 00401	PPC-200W-II-40. 40 lb/0.02 lb.	20kg/0.01kg.	516.50

-LEGAL FOR TRADE-

Stainless Steel Washdown Scales

For Batteries ▶ SEE PAGE 566

Washdown when powered by batteries.

- Digital LCD readout displays 1-inch numerals and also features auto shutoff and push button tare, zero reset and low battery indicator.
- Removable 9-inch x 7-1/2-inch platform for easy washdown. • Class III rated.
- Scales weigh in pound/decimal pound and gram/kilogram. • Shipping Weight: 8 pounds.
- Six D batteries required, sold separately. ➔

AND
A&D Weighing



ITEM NO.	MODEL	POUNDS (lb) CAPACITY/ RESOLUTION	GRAMS (g) CAPACITY/ RESOLUTION	EACH
3416 1001	SK-1000WP 2.2 lb/0.001 lb	1,000g/0.5g	\$458.00
3416 2002	SK-2000WP 4.4 lb/0.002 lb	2,000g/1g	458.00
3416 5002	SK-5000WP 11 lb/0.005 lb.	5,000g/2g	458.00
3416 0011	SK-10KWP 22 lb/0.01 lb.	10kg/0.005kg.	458.00
3416 0021	SK-20KWP 44 lb/0.02 lb.	20kg/0.01kg.	458.00
3416 00041	Optional Adapter			62.35



NOTE: AC adapter sold separately.

-LEGAL FOR TRADE-

Stainless Steel Washdown Safe Scale

Washdown when powered by batteries.

- Weighs in grams, pounds or ounces. • Easy-to-read 1/3000 resolution LCD display.
- 6-4/5-inch x 5-2/5-inch stainless steel platform. • Auto power off. • Tare function.
- Stability indicator and adjustable legs keep scale level.
- Overall dimensions: 6-4/5 inches L x 8-7/10 inches D x 2½ inches H.
- Shipping weight: 2 pounds. • Six AA batteries required, not included. 🔋

▶ SEE PAGE 566
For Batteries

NOTE: AC adapter sold separately.



ITEM NO.	MODEL	POUNDS (lb) CAPACITY/ RESOLUTION	GRAMS (g) CAPACITY/ RESOLUTION	EACH
3416 3000	HL-3000L-WPN	6.6 lb/0.002 lb	3,000g/1g	\$417.62
3416 00041	Optional Adapter			62.35

-LEGAL FOR TRADE-

Washdown Compact Scales

Ideal for fast and accurate checkweighing in washdown and dusty applications.

- Large LCD digits provides excellent visibility.
- 5,000-hour continuous operation with batteries, LED and backlight off.
- Key lock function prevents unwanted changes to settings.
- Custom auto power OFF function avoids wasting power.
- Four selectable weighing resolutions: 1/3,000, 1/6,000 (or 1/7,500), 1/12,000 (or 15,000), and 1/30,000.
- Multiple weighing units: gram, kilogram, pound, ounce, troy ounce, pound-ounce, tael (Singapore/HK jewelry/ Taiwan), tola and Newton.
- Counting mode to count a number of small pieces of the same weight instantly and precisely.
- Take-away check weighing possible using auto-tare and negative comparison functions.
- Six D batteries required, sold separately. 🔋



▶ SEE PAGE 566
For Batteries



-LEGAL FOR TRADE-

With the innovative 5-step light system it's easy to get fast, accurate filling and checkweighing processes completed in a fraction of the time it took before.



ITEM NO.	MODEL	POUNDS (lb) CAPACITY/ RESOLUTION	EACH
3416 00151	SJ-3000WP	6.6 lb/0.0002 lb	\$607.16
3416 00161	SJ-6000WP	13 lb/0.0005 lb	616.96
3416 00171	SJ-15KWP	33 lb/0.001 lb	642.92
3416 00181	SJ-30KWP	66 lb/0.002 lb	649.94

Washdown Compact Scales with Bluetooth

Same great scale as above now with Bluetooth connectivity.

Two ways to connect:

- USB fob (AD-8541-PC): Uses Bluetooth to send and receive data to and from a PC to your scale.
- External Remote Display (AD-8931): Receives and displays weighing values from the scale. Stands on a table or wall-mount.
- Bluetooth range: approx. 10 meters.
- Scales require six D batteries required, sold separately. 🔋



NOTE: If connecting device is Bluetooth compatible, USB fob (A) is not required.



A

B

ITEM NO.	MODEL	POUNDS (lb) CAPACITY/ RESOLUTION	EACH
3416 0036	SJ-3000WP-BT	6.6 lb/0.0002 lb	\$701.80
3416 0035	SJ-6000WP-BT	13 lb/0.0005 lb	701.80
3416 0032	SJ-15KWP-BT	33 lb/0.001 lb	725.00
3416 0037	SJ-30KWP-BT	66 lb/0.002 lb	759.90
3416 0034	A. AD-8541-PC USB Bluetooth Fob		139.95
3416 0033	B. AD-8931 External Display		104.95



▶ SEE PAGE 566
For Batteries

HOW TO BUY A BLUETOOTH SCALE

1. Choose your scale.
2. Choose your Bluetooth connectivity device (if necessary).

CALL 800-456-5624 for more information

Rechargeable Portion Control Scales

Five-way weight display shows weight in pounds; pounds and ounces; ounces; kilograms and grams.

- Operates on an internal rechargeable battery or with a recharger/adaptor.
- Continues to weigh while recharging – fully recharged in less than 4 hours.
- “Quad-Spring” base design virtually eliminates damage from shock and overload.
- Overall dimensions: 6-1/2 inches L x 8-3/4 inches D x 2 inches H.
- Case and removable platter are constructed of food grade 304 stainless steel and is wipe down safe.
- Shipping weight: 5 pounds. • Includes 115 V AC charger/adaptor.
- 15-hour rechargeable battery included. 

doran®

NSF



NOTE: AC adapter INCLUDED.

ITEM NO.	MODEL	POUNDS (lb) CAPACITY/ RESOLUTION	GRAMS (g) CAPACITY/ RESOLUTION	OUNCES (oz.) CAPACITY/ RESOLUTION	EACH
3435 0002	PC-400-02	2 lb/-	-/1g	40 oz./0.02 oz.	\$333.95
3435 0039	Replacement Adapter				54.95

-LEGAL FOR TRADE-

Checkweigh Scale

Fast Stability Time — accurate reading is completed in less than one second.

- Status indication function — battery, stable, zero and net.
- High resolution, easy-to-read LCD display.
- Full digital calibration function. 9-inch x 7-1/2-inch stainless steel platform.
- Spirit level and adjustable feet for accurate weighing.
- Overall dimensions: 10-2/5 inches L x 9-4/5 inches D x 4-1/10 inches H.
- Weight in kilograms, decimal pounds, ounces or decimal ounces.
- Shipping Weight: 4.6 pounds. • Auto power off.
- Six D batteries required, sold separately. 

NSF

A&D
A&D Weighing

NOTE: AC adapter sold separately.



-LEGAL FOR TRADE-

For Batteries ▶ SEE PAGE 566

ITEM NO.	MODEL	POUNDS (lb) CAPACITY/ RESOLUTION	KILOGRAMS (kg) CAPACITY/ RESOLUTION	OUNCES (oz.) CAPACITY/ RESOLUTION	POUNDS to OUNCES CAPACITY/ RESOLUTION	EACH
3416 20121	SJ-12KHS	26 lb/0.01 lb.	12kg/0.0005kg.	423 oz./0.2 oz.	26 lb/1 oz.	\$235.06
3416 00041	Optional Adapter					62.35

Low Profile Bench Scales

Built to last, easy to operate.

- One second response time. • Weighs in pounds, kilograms and ounces.
- Stainless steel weigh pan: 12 inches x 15 inches (300 x 380 mm).
- Resolution: 0.005 pounds/0.002 kilograms/0.1 ounces.
- Battery operating: approximately 150 hours with alkaline dry cell battery.
- AC or battery operation. • Shipping weight: 21 pounds.
- Four C batteries required. 

For Batteries ▶ SEE PAGE 566

-LEGAL FOR TRADE-

ITEM NO.	MODEL	CAPACITY	F.O.B. FACTORY EACH
3416 00261	FG-30KBM.	60 lb.	\$677.12
3416 00271	FG-60KBM.	150 lb.	677.12
3416 00281	FG-150KBM.	300 lb.	719.98
3416 00041	Replacement Adapter		62.35

A&D
A&D Weighing



NOTE: AC adapter INCLUDED.

Stainless Steel Washdown Bench Scale

Stainless steel washdown construction is dust- and water-resistant.

- IP65 rated washdown construction with stainless steel pan.
- Resolution can be changed automatically for three capacity levels.
- Tilttable display with 10-digit keypad and memory storage.
- Triple weighing range function. • Set your own high and low weight targets.
- Change the weighing units and mode with the press of a button.
- Accumulation and counting functions.
- LED comparator traffic lights. • A/C main (100 to 240 V).



-LEGAL FOR TRADE-

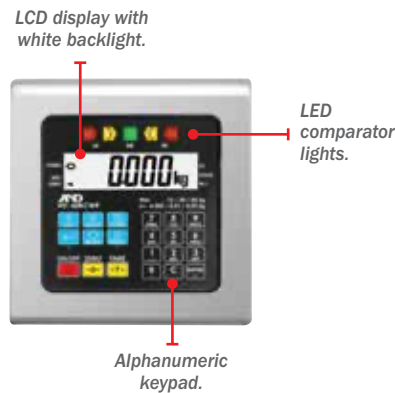

ITEM NO.	MODEL	CAPACITY	RESOLUTION	PLATFORM	F.O.B. FACTORY EACH
3416 1015	HV-15KC-WP	30 lb.	0.01 lb.	9-4/5" x 9-4/5"	\$2,084.20
3416 1060	HV-60KC-WP	150 lb.	0.05 lb.	13" x 16-7/10"	2,454.30
3416 1200	HV-200KC-WP	500 lb.	0.2 lb.	15-2/5" x 20-9/10"	2,085.77

DP-6900 Bench/Receiving Scales

Features removable stainless steel platform.

- Large, easy-to-read display shows units displayed in pounds, ounces, pounds/ounces or kilograms.
- Tilting and rotating LCD display with annunciators.
- Includes a lighted over/under checkweighing function.
- 13-4/5-inch x 19-7/10-inch removable stainless steel platform and housing for easy clean-up.
- Auto shut-off.
- Internal rechargeable battery and A/C adaptor operation.



-LEGAL FOR TRADE-

**NOTE:
AC adapter
INCLUDED.**



ITEM NO.	MODEL	CAPACITY	RESOLUTION	F.O.B. FACTORY EACH
4893 0018	DP-6900-60	60 lb.	0.05 oz.	\$730.95
4893 0015	DP-6900-150	150 lb.	1.0 oz.	730.95
4893 0016	DP-6900-300	300 lb.	2.0 oz.	730.95
4893 00191	Replacement Adaptor			30.85

Hanging Dial Scale with S-Hook

- 4-inch heavy-duty plated S-hook.
- 8 inch diameter dial.
- 40 pound capacity:
20 pounds - 1st revolution
40 pounds - 2nd revolution
- Shipping weight:
4 pounds/1.8 kilograms.



ITEM NO.	MODEL	CAPACITY	EACH
3552 00401	MCS-40H	40 lb (20 lb x 2 oz.)	\$374.17

Hanging Scoop Dial Scale

- Galvanized 11-inch x 16-inch x 5-inch scoop with chains.
- 8 inch diameter dial.
- 40 pound capacity:
20 pounds - 1st revolution
40 pounds - 2nd revolution
- Shipping weight:
5 pounds/2.3 kilograms.

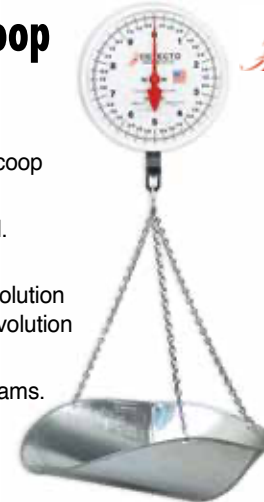

ITEM NO.	MODEL	CAPACITY	EACH
3552 10401	MCS-40P	40 lb (20 lb x 2 oz.)	\$385.28

Stainless Steel Dial Scales

- These compact, portable dial scales were developed as a result of tests conducted in cooperation with Federal Inspectors and plant managers.
- All interior parts are nickel- and zinc-plated, housing is stainless steel.
- Two capacity ranges available: 32 ounces x 1/8 ounces or 5 pounds x 0.5 ounce.
- Removable 7-1/2-inch x 7-1/2-inch stainless steel platform cover snaps on and off for easy cleaning.



What's a Dashpot?

A stabilizing dial mechanism that eliminates time-consuming indicator needle bounce and provides instant readings.

A. Universal Dial Scales

- Accuracy is enhanced by temperature compensation and fine-tooth rack and pinion assembly.
- Strong under-platform construction with two supports and two spring mechanisms.
- Replacement plexiglass face plate available separately.
- Not legal for trade.
- Dimensions: 10-1/2 inches L x 7-1/2 inches W x 10-1/2 inches H.

ITEM NO.	MODEL	CAPACITY	EACH
4893 00281	SM28PK	2 lb x 0.125 oz (No Dashpot)	\$191.25
4893 20051	SM5PK	5 lb x 0.5 oz. (No Dashpot)	191.25
4893 10281	DSM28PK	2 lb x 0.125 oz. (Includes Dashpot)	251.95
4893 00431	Replacement Face Plate		18.65



B. Portion Control Dial Scales

- Patented rotating dial with three over/under tolerance zones.
- Easy-to-read "target" zones of acceptable weight.
- Replacement plexiglass face plate and ring available separately.
- Dashpot included.

ITEM NO.	MODEL	CAPACITY	EACH
4893 10021	A. CW2SS	2 lb x 0.125 oz.	\$308.30
4893 10051	B. CW5SS	5 lb x 0.5 oz.	308.30
4893 00451	Replacement Ring		21.90
4893 00431	Replacement Face Plate		18.65

Stainless Steel American Calibration Weight Set

Calibration weights test accuracy of commercial scales quickly and easily.

- Complies with NIST Class F tolerance and specifications.
- Tests most accuracy class III scales and scales not marked with a class designation.
- Required for all Legal For Trade applications (include any products that are sold by weight).
- Certificate of Accuracy — states the weight(s) were manufactured per NIST accuracy guidelines.
- Traceable Certificate - states the weight(s) are tested and linked directly to the NIST specific standard applicable to weight class.
- Case size: 8-1/2 inches x 7-1/4 inches x 3-1/4 inches. • Shipping weight: 3-1/2 pounds.

***NOTE: Certificate of Accuracy or Traceable Certificate must be ordered at time of purchase.**

Metric Weights

ITEM NO.	CAPACITY	F.O.B. FACTORY EACH
3277 25121	Metric Weight Set, Stainless Steel, 500g-1g Class F	\$390.15
3277 25111	500g Individual	78.26
3277 25131	1kg NIST Individual	83.24
3277 25171	3kg Individual	202.78
3277 25211	5kg NIST Individual	246.29
3277 25301	300g Individual Stainless Steel	76.91
3277 2523	20g Individual Stainless Steel	44.48

American Weights

ITEM NO.	CAPACITY	F.O.B. FACTORY EACH
3277 2594	8 oz. Individual	\$52.07
3277 2596	1 lb Individual	75.69
3277 2598	2 lb Individual	83.50
3277 2604	5 lb Individual	142.24
3277 2606	10 lb Individual	239.50
3277 2677	50 lb Individual	876.30

ITEM NO.	CAPACITY	F.O.B. FACTORY EACH
3277 0214	Calibration Weight Set	\$348.89
3277 6092	Certification of Accuracy*	54.00
3277 25951	Traceable Certificate*	311.75

- 1-pound weight
- 8-ounce weight
- 4-ounce weight
- 2-ounce weight
- 1-ounce weight
- 0.5-ounce weight
- (2) 0.2-ounce weights
- 0.1-ounce weight
- 0.05-ounce weight
- Plastic case with foam lining



MADE IN USA

DIGITAL SCALE COMPARISON CHART

1 pound = 16 ounces = 453.59 grams

SCALE TYPE	ITEM NO.	WEIGHT UNITS		LEGAL FOR TRADE	NSF APPROVED	POWER SOURCE		HOUSING		IP RATING
		STANDARD	METRIC			AC	DC	STAINLESS STEEL	PLASTIC	
Bench	3416 00261	✓	✓	✓		✓	✓	✓		
	3416 00271	✓	✓	✓		✓	✓	✓		
	3416 00281	✓	✓	✓		✓	✓	✓		
	4893 0018	✓	✓	✓		✓	✓	✓		
	4893 0015	✓	✓	✓		✓	✓	✓		
	4893 0016	✓	✓	✓		✓	✓	✓		
Checkweigh	3416 20121	✓	✓	✓		✓	✓	✓		IP68/65
Washdown	3416 00151	✓	✓		✓	Batteries			✓	IP67
	3416 00161	✓	✓	✓	✓	Batteries			✓	IP67
	3416 00171	✓	✓	✓	✓	Batteries			✓	IP67
	3416 00181	✓	✓	✓	✓	Batteries			✓	IP67
	3416 0036	✓	✓		✓	Batteries			✓	IP67
	3416 0035	✓	✓		✓	Batteries			✓	IP67
	3416 0032	✓	✓		✓	Batteries			✓	IP67
	3416 0037	✓	✓		✓	Batteries			✓	IP67
	4893 00401	✓	✓	✓		✓	✓		✓	IP65
	4893 00391	✓	✓	✓		✓			✓	IP65
	4893 00411	✓	✓	✓		✓			✓	IP65
	4893 65551	✓	✓	✓		✓	✓		✓	IP65
	3416 1001	✓	✓	✓	✓	✓	✓	✓		IP65
	3416 2002	✓	✓	✓	✓	✓	✓	✓		IP65
	3416 5002	✓	✓	✓	✓	✓	✓	✓		IP65
3416 0011	✓	✓	✓	✓	✓	✓	✓		IP65	
3416 0021	✓	✓	✓	✓	✓	✓	✓		IP65	
4893 03211	✓	✓		✓	✓	✓	✓		IP68/85	
4893 30111	✓	✓		✓	✓	✓	✓		IP68/85	
4893 00211	✓	✓		✓	✓	✓	✓		IP68/85	
4893 00441	✓	✓		✓	✓	✓	✓		IP68/85	
3416 1015	✓		✓		✓		✓			
3416 1200			✓		✓		✓		IP65	
3416 1060	✓		✓		✓		✓			
Washdown/Food Service	3416 3000	✓	✓	✓	✓	✓	✓	✓		IP65
Rechargeable	3435 0002	✓	✓	✓	✓	✓	✓	✓		
	3435 0039	✓	✓	✓	✓			✓		



FREE GROUND SHIPPING
 when you place an order
 for \$500 or more from
THIS BUYERS GUIDE!

*FREE SHIPPING does NOT include UPS Next Day Air, UPS 2nd Day or UPS 3rd Day Select. Certain items may not qualify. This offer is good only on orders shipped UPS Ground in the 48 contiguous states. Based on dimensional weight, we will determine the most efficient means of shipment, either UPS or LTL. Products may ship by truckline.

SHOP 24/7

bunzlpd.com

Where you can find out what's on sale, find updated product information, reviews and pricing.



STAY CONNECTED WITH US:



Need Help?
Chat With Us
Online!



THERMOMETERS



FIND IT FAST

Thermometer Comparison Chart	524
Big Red® Thermometer	525
Digital Thermometer	525-529
Bi-Metal and Dial Thermometers	530-531
Wall Thermometers	532
Probe Wipes	532
Infrared and Specialty Thermometers	533
Thermometer Calibration Chart	534
Calibration Devices	535
Recording Thermometers	536-537

WHICH THERMOMETER IS RIGHT FOR YOU?

TYPE	CONSTRUCTION	STYLES	USES
GLASS	<ul style="list-style-type: none"> Usually filled with mercury, spirit-filled or biodegradable liquids. Handled delicately because they are fragile and can be easily broken. 	<ul style="list-style-type: none"> Partial immersion. Total immersion. 	<ul style="list-style-type: none"> Partial immersion: Designed for areas with limited space. Subject to outside temperature variables. Total immersion: Placed entirely into the liquid, therefore, are more accurate – however, more space is required to obtain readings.
ANALOG Dial/Bi-Metal	<ul style="list-style-type: none"> Metal or plastic. Insert probe into the material being measured, the dial face is easily read. Good substitute for glass thermometer. 	<ul style="list-style-type: none"> Standard dial face with probe. 	<ul style="list-style-type: none"> Instead of glass thermometers for applications requiring more durability. Used around food.
DIGITAL	<ul style="list-style-type: none"> Most constructed with a plastic housing, which holds the digital components, and a metal probe. 	<ul style="list-style-type: none"> Most common uses a thermocouple probe that is designated by the letters, "K", "J" or "T"; and various probe shapes are available. 	<ul style="list-style-type: none"> Used in many applications – often to measure liquids, gases and solids. Durable and easy to use.
INFRARED Non-Contact	<ul style="list-style-type: none"> Usually constructed of plastic with electronic components. 	<ul style="list-style-type: none"> Designed to collect energy that has been reflected or emitted from a surface and converts that energy into a specific temperature. 	<ul style="list-style-type: none"> Perfect for use on moving objects, hard-to-reach objects and hazardous materials. NOTE: Accuracy diminishes the farther away from the object, and these thermometers are not recommended for HACCP environment or product temperatures.

DIGITAL THERMOMETER COMPARISON CHART

ITEM#	CONSTRUCTION	WATERPROOF/ WATER-RESISTANT	FIELD RECALIBRATABLE	POWER/ BATTERY TYPE	TEMPERATURE RANGE	PROBE TYPE	INTERCHANGE PROBES
A692 00011	Infrared, Food Service Non-Contact	No	No	9 V	-25° to 400 °F -30° to 200 °C	N/A	N/A
A692 00181	C48 Thermometer with Clock and Timer	Yes	No	Two AA	-328° to 2,502 °F -200° to 600 °C	Thermocouple Type K	Yes
A692 90941	Digital Food Processing with Clock	Yes	No	10 Year Battery Life	-328° to 752 °F -200° to 400 °C	Thermocouple Type T	Yes
E542 59091	BIG RED® Water-Resistant, T-Handle	Yes	Yes	1.5 V	-58° to 572 °F -50° to 280 °C	N/A	No
3098 01131	Atkins EconoTemp	No	No	Three AAA	-40° to 500 °F -40° to 260 °C	Thermocouple Type K	Yes
3098 22091	Infrared Thermometer	No	No	Two AAA	-76° to 932 °F -60° to 500 °C	N/A	N/A
L222 00011	Infrared Forehead Thermometer	No	Yes	1.5 V	32° to 140 °F 0° to 60 °C	N/A	N/A
3098 51321	Atkins 351 AquaTuff™ Digital Wrap and Stow	Yes	No	Two AAA	-100° to 500 °F -73° to 260 °C	Thermocouple Type K	Yes
3443 1051	Heavy-Duty Digital	No	No	Four 1.5 V	-58° to 527 °F -50° to 275 °C	NTC	Yes
3542 41211	Digital Pocket	No	No	1.5 V	-58° to 500 °F -50° to 260 °C	N/A	No
3098 0450	Digital Pocket Thermometer w/Temp. Alarm	Yes	Yes	1.5 V	-40° to 450 °F -40° to 232 °C	N/A	N/A
3542 98671	Digital Thermometer with Folding Probe	Yes	Yes	Two AAA	-40° to 572 °F -40° to 300 °C	Reduced Tip	No
4599 10401	Digital Min./Max. Lollipop	Yes	No	1.5 V	-40° to 311 °F -40° to 155 °C	N/A	No
4599 10501	Digital Auto and Manual Lollipop	Yes	No	1.5 V	-40° to 311 °F -40° to 155 °C	Reduced Tip	No
4599 00071	Digital 8" Stem Lollipop	Yes	No	1.5 V	-58° to 392 °F -50° to 200 °C	Extended Tip	No
4599 10631	Digital Needle Probe Thermometer	Yes	Yes	1.5 V	-40° to 311 °F -40° to 155 °C	Reduced Tip	No

BIG RED® Water-Resistant, T-Handle Pocket Thermometer

- Extra-sturdy, T-handled 4-1/2-inch stainless steel probe for firm or semi-firm product.
- T-handle overall dimension: 6 inches x 3-1/2 inches x 1-1/2 inches.
- Large readout, auto shut off. • Accurate to ±2 °F. • 0.1 °F/°C resolution.
- Range: -58° to 572 °F/-50° to 300 °C.
- Requires LR 1.5 V battery (included). 



Includes pocket clip sheath for stem protection.



For Replacement Batteries ▶ SEE PAGE 566

ITEM NO.	PRODUCT	EACH
E542 59091	T-Handle Pocket Thermometer	\$28.75

Waterproof Digital Lollipop Thermometers

Can be used as a food or dishwasher holding thermometer.

- IP65 Waterproof housing. • °C/°F switchable. • Display reading update: 1 second.
- Min./Max. memory stores lowest/highest readings. • Resolution: 0.1 °F /°C.
- Requires 1.5 V LR44 battery (included). 
- (A) Measurement Range: -40° to 311 °F/-40° to 155 °C
Operating Range: 32° to 122 °F/0° to 50 °C.
- (B) Measurement Range: -40° to 311 °F/-40° to 155 °C
Operating Range: 32° to 122 °F/0° to 50 °C.
- (C) Measurement Range: -58° to 392 °F/-50° to 200 °C
Operating Range: 32° to 122 °F/0° to 50 °C.



NOTE: All styles include probe cover with pocket clip. Styles A and B also have a hanging loop.



▶ SEE PAGE 566
For Replacement Batteries

ITEM NO.	PRODUCT	MODEL	EACH
4599 10401	A. Factory Calibrated Waterproof, 4-1/8" Stem	11040	\$15.95
4599 10501	B. Auto and Manual Waterproof, 4-1/8" Stem	11050	22.95
4599 00071	C. 8" Stem Waterproof.	11047	39.95

Heavy-Duty Digital Thermometer

Auto hold feature tells when the temperature reading is stable for a set duration of time.

- Measure the temperature of semi-solid foods.
- Range: -58° to 527 °F/-50° to 275 °C. Accurate to ±1 °C.
- Heavy-duty 100 mm (3.93 inch) long stem.
- 0.1 °C resolution.
- Ergonomically designed to fit comfortably into hand.
- Limit the value setting with a visual and audible alarm.
- Turns off automatically after 10 minutes of no use.
- Requires 4, 1.5 V batteries (included). 



Includes a belt clip sheath for probe protection.



NOTE: Frozen food corkscrew probe also available.

ITEM NO.	PRODUCT	EACH
3443 1051	Thermometer w/Heavy-Duty Stem.	\$319.27
3443 10531	Optional Corkscrew Probe.	216.86

Waterproof Digital Pocket Thermometer with Temperature Alarm

Thermometer can be programmed to provide a visual alarm once the set temperature is reached.

- Anti-microbial plastic* case inhibits growth of pathogens.
- Eliminate the risk of a mercury spill — thermometer stores the maximum heat registered and is waterproof.
- Range -40° to 450°F/-40 to 232 °C. Accurate ± 2 °F/ ± 1 °C.
- 4-1/2-inch stem length with reduced tip for delicate products and quick (<6 seconds) response time.
- Auto off after 10 minutes of non-use.
- Includes yellow, anti-microbial casing and sleeve.
- Dishwasher safe.
- Maximum and minimum temperature memory, plus hold mode.
- Requires 1.5 V battery (included). 

For Replacement Batteries ► SEE PAGE 566



ITEM NO.	PRODUCT	EACH
3098 0450	Pocket Thermometer	\$46.88

*The anti-microbial additive does not protect users or others against food bacteria. Always clean and wash this product thoroughly before and after each use.

Waterproof Digital Thermometer

Anti-Microbial additive* in plastic case inhibits growth of pathogens.

- Range: -40° to 392 °F/-40° to 200 °C.
- Min./Max. and hold modes. • 6 second response time.
- °C/°F switchable. • Probe: 2-3/4 inches.
- Requires 1.5 V battery (included). 

Cooper
ATKINS

► SEE PAGE 566
For Replacement Batteries



Clips easily onto pocket when not in use.

ITEM NO.	PRODUCT	EACH
3611 00441	Waterproof Digital Probe.	\$35.05

*The anti-microbial additive does not protect users or others against food bacteria. Always clean and wash this product thoroughly before and after each use.

Commercial Thermocouple Thermometer with Folding Probe

Probe folds into two angles, plus into itself for easy storage.

- Easy-to-read LCD readout.
- Temperature range -40° to 572 °F/-40° to 300 °C.
- 1.5 mm FDA recommended step down probe tip.
- Stabilized reading in 5 seconds or less.
- ± 2 °F/ ± 1 °C between 14° to 212 °F/-10° to 100 °C.
- ± 3.6 °F/ ± 2 °C balance of range.
- Resolution: 0.1 °F / 0.1 °C.
- 4-inch stainless steel probe. • Calibratable.
- Hold and auto off features.
- Requires two AAA batteries (included). 

► SEE PAGE 566
For Replacement Batteries



Probe folds into thermometer casing for storage.

ITEM NO.	PRODUCT	EACH
3542 98671	Folding Probe Thermometer	\$73.95

Needle Probe Thermometer

Waterproof thermometer — recommended for food safety in all commercial food service facilities.

- Ideal for measuring the temperature of “thin mass” foods.
- Stainless steel reduced tip probe length: 3.90 inches.
- Needle probe diameter: 0.067 inches.
- Unit automatically shuts off after 10 minutes.
- Range: -40° to 311 °F/-40° to 155 °C.
- Auto-calibration.
- Requires 1.5 V battery (included).



▶ SEE PAGE 566
For Replacement Batteries



Clips easily onto pocket for storage when not in use.

ITEM NO.	PRODUCT	EACH
4599 10631	Digital Thermometer	\$25.95

Digital Thermometer

- Range: -40° to 500 °F/-40° to 260 °C.
- 0.1 °F/C resolution.
- Continuous update.
- 5-inch stainless steel stem.
- Flat edge design won't roll-off counters.
- Pocket clip sheath for stem protection.
- Requires 1.5 V battery (included).



▶ SEE PAGE 566
For Replacement Batteries



ITEM NO.	PRODUCT	EACH
3542 41211	Digital Thermometer	\$19.95

Atkins AquaTuff™ Waterproof 351 Wrap&Stow™ Digital Thermometer

Designed for precise temperature measurement with Total System Accuracy™ of ±0.9 °F/±0.5 °C.

- 32-inch cable features “wrap and stow” storage.
- Water-resistant construction. rugged ABS plastic housing.
- Heavy-duty patented probe cable is reinforced with Kevlar® and stainless steel braid.
- DuraNeedle probe can be replaced with any type “K” probe shown below.
- Probe is calibrated with instrument for Total System Accuracy™.
- Temperature range: -100° to 500 °F/-73° to 260 °C.
- Quickly switch between Fahrenheit and Celsius.
- Auto shut off after 10 minutes of non-use.
- Includes 5 year manufacturer warranty on thermometer unit.
- Compact size: 2-1/10 inches x 6-1/4 inches x 1 inch.
- Requires two AAA batteries (included).



Wrap&Stow™ probes can be easily replaced in the field without tools or need for calibration.

▶ SEE PAGE 566
For Replacement Batteries

Large, easy-to-read LCD screen.

Wind cord and secure probe into side channel for protection and convenience.



Atkins AquaTuff™ Waterproof 351 Digital Thermometer



- Uses any K-Type probe. Sold separately.
- Temp. range: -100 °F to 999 °F (-73 °C to 537 °C).



ITEM NO.	PRODUCT	EACH
3098 51321	AquaTuff™ 351 Wrap&Stow™ Thermometer w/DuraNeedle Probe	\$424.00
3098 50321	DuraNeedle Wrap&Stow™ Replacement Probe	166.19
3098 50401	MicroNeedle Wrap&Stow™ Optional Probe	166.19

ITEM NO.	PRODUCT
3098 51001	AquaTuff™ 351, No Probe

EACH
\$368.89

Atkins EconoTemp Thermometer

- Type "K" thermocouple.
- Temperature range: -40° to 500 °F/-40° to 260 °C.
- Accuracy ± 2 °F/ ± 1 °C.
- Flash-based micro-controller hardware circuit design.
- Low battery indicator and auto shut off.
- Custom LCD with easy-to-read screen.
- Shock-resistant rubber boot for added protection.
- 6-inch probe with a coil cable.
- Includes standard probe.
- Also available with a heavy-duty probe.
- Dimensions: 2-1/2 inches L x 1 inch D x 6-1/2 inches H.
- Requires three AAA batteries (included). 



► SEE PAGE 566
For Replacement Batteries



ITEM NO.	PRODUCT	EACH
3098 00311	EconoTemp Thermometer Kit (Heavy-Duty DuraNeedle Probe and Case)	\$254.98
3098 32301	Thermometer w/Heavy-Duty Probe	335.42
3098 0336	Replacement 6" Heavy-Duty DuraNeedle Probe	127.46

TYPE "K" THERMOCOUPLE Optional Probes

- All type "K" thermocouple probes are interchangeable and may be used with any digital thermometer requiring one.
- Features a high-visibility yellow coiled cord.

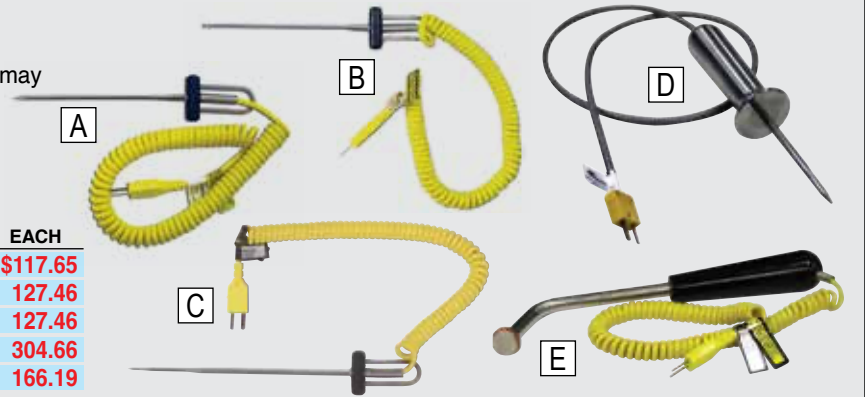

ITEM NO.	PRODUCT	EACH
3098 0335	A. 4-1/2" Penetration Probe	\$117.65
3098 0332	B. Air Sensor Probe	127.46
3098 0336	Replacement 6" Heavy-Duty DuraNeedle Probe	127.46
3098 0101	D. 6" Frozen Product Probe	304.66
3098 0012	E. Angled Bell Surface Probe	166.19

Digital Food Processing Thermometer with Clock

Extra-tough, waterproof housing makes this thermometer perfect for the food processing and seafood industries. Plus, it has a 2-year battery life guarantee!

- Permanent clock reading, countdown timer and data hold all displayed on the easy-to-read screen.
- Heavy-duty ABS plastic housing with an antimicrobial agent that reduces potential contaminations.
- Countdown timer determines how long probe is in product to obtain the most accurate of readings.
- Secure Lumberg probe connection with coil cable extending over 3 feet.
- Range: - 328° to 752 °F/-200° to 400 °C. Accuracy: ± 0.9 °F/ ± 0.5 °C.
- Type T thermocouple standard. • Auto switch-off after 3-, 10-, or 30-minutes.
- Reinforced 4-inch stainless steel probe.
- Dimensions: 3-1/10 inches L x 1-1/5 inches D x 7-1/5 inches H.
- Operates on two 3.6 V lithium cell batteries (included). 



Rubber boot protects from impact damage, extending unit life. Pops off for easy cleaning.

ITEM NO.	PRODUCT	EACH
A692 90941	Thermometer w/Penetration Probe & Protective Boot	\$469.40
A692 00271	Replacement 4" Penetration Probe	87.73
A692 02291	Optional 5-1/2" Corkscrew Probe	365.30
A692 00261	Optional 4" Penetration Probe w/Heat-Resistant Lead	87.73

NOTE: Batteries are non-replaceable to increase waterproof rating.



Optional corkscrew probe.

C48 Thermocouple Thermometer

This digital thermometer includes MAX., MIN. and HOLD functions, for improved convenience.

- Type K thermocouple. • Easy-to-read display. • Min./Max. button.
- Rugged, waterproof polycarbonate case with Biocote® antimicrobial protection.
- Rated IP65/IP67 dust and waterproof standards.
- Includes a clock function with countdown timer that checks how long a probe is inserted for a more accurate reading.
- Temperature Range: -328° to 2502 °F/-200° to 1372 °C.
- Accurate within 0.04 °F/0.02 °C.
- Selective auto switch-off preserves battery life. • Probes sold separately.
- Requires two AA batteries (included).

► SEE PAGE 566
For Replacement Batteries



Optional Soft Carrying Case.



A

Large, easy-to-read display. Includes clock function with countdown timer which checks how long a probe is inserted for a more accurate reading.

ITEM NO.	PRODUCT	EACH
A692 00181	A. C48 Thermocouple Food Thermometer	\$197.91
A692 03151	B. Optional Soft Carrying Case	24.36

Probes Sold Separately Choose from the following three:



Tapered Penetration Probe. Heavy-duty reinforced ring with a tapered probe shaft allowing temperature to transfer faster.



Penetration Probe. Heavy-duty reinforced ring.



Stainless Steel Oven Probe. Withstands up to 350 °F.

ITEM NO.	PRODUCT	EACH
A692 00191	C. Optional Tapered Penetration Probe, 3-1/2" Long, 1/16" Diameter	\$84.35
A692 00241	D. Optional Penetration Probe, 4" Long, 1/8" Diameter	75.58
A692 00231	E. Optional Stainless Steel Oven Probe, Heat-Resistant Lead	101.00

TYPE "K" THERMOCOUPLE PROBE — WORKS WITH ANY THERMOCOUPLE THERMOMETER!

HACCP Approved Dial Pocket Thermometer

3-Point Calibration. Rustproof—dust proof—leakproof. Hermetically sealed.

- Ranges: 0° to 220 °F or -40° to 160 °F. • High-visibility dial graphics.
- PT-50R accuracy to within ±0.5°. • 5-inch stem. • Lexan® lens.

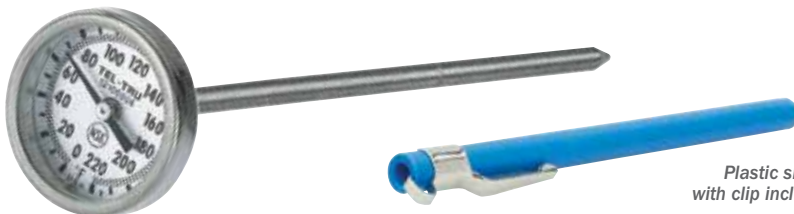

Plastic sheath with clip included.

ITEM NO.	PRODUCT	EACH
3327 1050	0° to +220 °F	\$25.94
3327 0050	-40° to +160 °F	25.94

Thermometer Pan Clip

- Stainless steel construction.
- Perfect for hands-free temp monitoring.



ITEM NO.	PRODUCT	EACH
3327 2401	Pan Clip	\$3.42

Stainless Steel Bi-Metal Pocket Dial Thermometers

- 1-inch dial thermometer comes with plastic sheath with clip.
- External easy recalibration.
- Accuracy ±1 °F at calibration point.
- All stainless steel external parts.
- Shatter-resistant plastic lens.
- NSF approved.

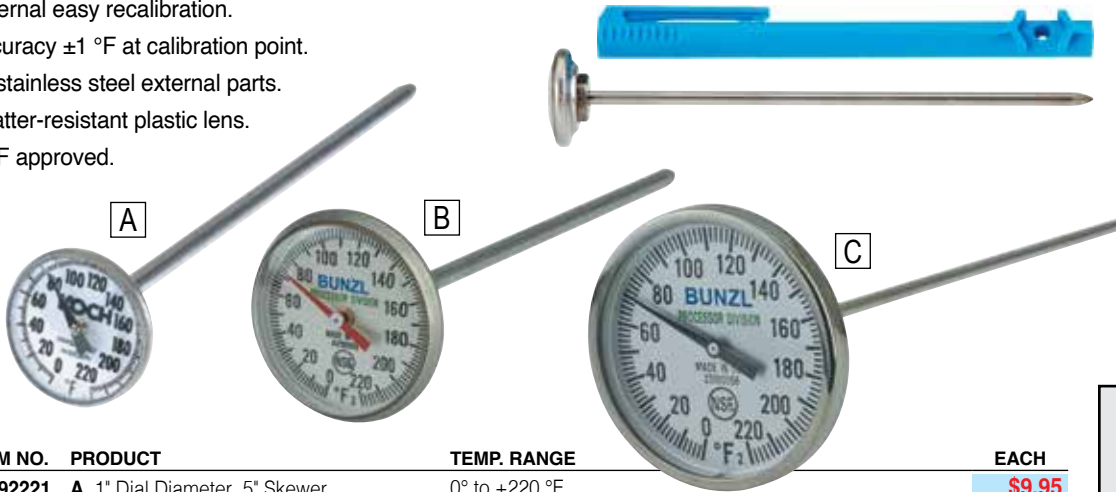

1-inch dial includes probe sheath and pocket clip. FREE Calibration tool included on sheath.

ITEM NO.	PRODUCT	TEMP. RANGE	EACH
3542 92221	A. 1" Dial Diameter, 5" Skewer	.0° to +220 °F	\$9.95
3542 9621	1" Dial Diameter, 5" Skewer	-40° to +160 °F	8.95
3327 0044	B. 1-3/8" Dial Diameter, 5" Skewer	.0° to +220°F	23.53
3327 0225	2" Dial Diameter, 5" Skewer	.0° to +220°F	25.94
3327 1225	C. 2" Dial Diameter, 8" Skewer	.0° to +220°F	24.67

2-Inch Cooking Thermometer

- Stainless steel bi-metal thermometer has a heavy-duty 5-inch stem.
- Easy-to-read dial lists the "wellness" of meat (i.e. rare, medium and well-done).
- Hermetically sealed with heat compensated bezel.
- Designed with glass lens to withstand oven temperatures.

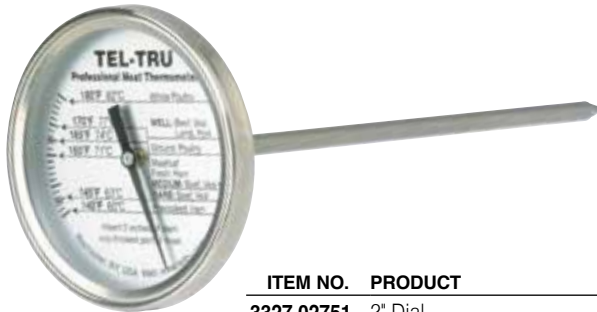

ITEM NO.	PRODUCT	TEMP. RANGE	EACH
3327 02751	2" Dial	.140° to 180 °F	\$35.35

Dual Scale Pocket Thermometer

- Plastic watertight lens.
- Stainless 5-inch stem.
- 1-3/4-inch dial.
- 3-pt. calibratable.
- External calibration nut.
- 0° to 220 °F/18° to 105 °C

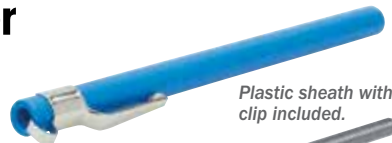

Plastic sheath with clip included.



ITEM NO.	PRODUCT
3327 3606	1-3/4" Dial

EACH
\$24.67



Stainless Steel 24-Inch Skewer Thermometer

Bi-metal economy, 2-inch dial thermometer.

- 2-inch dial.
- Shatter-resistant plastic lens.
- Long 24-inch skewer probe.
- For liquid and semi-viscous applications only.



ITEM NO.	PRODUCT
3327 2456	0° to +220 °F

EACH
\$67.15

Adjustable Angle, Bi-Metal Dial Thermometer

- 3-inch dial adjustable angle • 1/2-inch NPT connection.
- Glass lens (other options available).
- Head rotates 360° and stem positioning over 180°.
- Tru Anti-Parallax dial, easy-to-read from any angle.
- Accuracy ±1% full span per ASME B40.3 Grade A.
- Hermetic Seal per ASME B40.3 dust proof and leakproof.
- Temperature Range 0/250 °F/°C dual scale (custom ranges available).
- Stem length 2-1/2 inches x 1/4 inch diameter (custom lengths available).
- 304SS external parts. • Corrosion resistant to most chemicals.
- 8-year manufacturer warranty.



Stainless Steel Long Stem Thermometers

Ideal for many food and beverage or general lab use applications.

- Bi-metal, scale range: 0° to 250 °F, tapered tip for quick response time.
- 3-inch, anti-fog, shatterproof acrylic lens is hermetically sealed to housing.
- All stainless construction.
- Heavy-duty reinforced stem, pointed for easy insertion.
- Optional EZ-insertion threaded handle is easily removed for cleaning and storage. (order separately).



Optional, removable aluminum handle is recommended for use with long stems.



ITEM NO.	PRODUCT	EACH
3327 00271	Adjustable Angle, Bi-Metal Thermometer	\$130.81

Barbecue Thermometer with 4-Inch Stem

Therm can be installed on pit, smokers and cookers with installation kit (sold separately).

- All stainless steel barbecue thermometer.
- Heavy-duty construction.
- Hermetically sealed.
- 3-inch black dial with heat zones.
- 1/2-inch NPT connection.
- 4-inch stem x 1/4 inch dia.
- 100° to 500 °F temperature range.



ITEM NO.	PRODUCT	EACH
3327 43301	BBQ Bi-Metal Thermometer	\$82.34
3327 31011	Installation Kit	14.13

Pocket-Glo Thermometer

1-inch mini-dial "glows-in-the-dark" making it easy to read in low-light conditions.

- Recharge the face with room lighting or even a flashlight.
- External zero reset for easy recalibration.
- Ranges: 0° to 220 °F or -40° to 160 °F.



ITEM NO.	PRODUCT	EACH
3327 15591	1" Dial, 8" Stem, 0° to +220 °F.	\$29.48
3327 15541	1" Dial, 5" Stem, 0° to +220 °F.	29.48
3327 15531	1" Dial, 5" Stem, -40° to +160 °F.	29.48

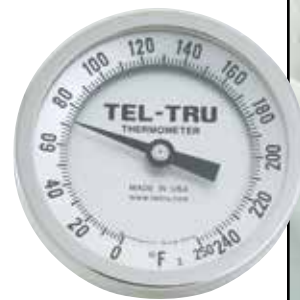

ITEM NO.	PRODUCT	EACH
3327 23001	12" Stem, 1/4" Diameter.	\$78.94
3327 18001	18" Stem, 3/8" Diameter	115.46
3327 24001	24" Stem, 3/8" Diameter.	169.73
3327 3667	36" Stem, 3/8" Diameter.	194.46
3327 83001	48" Stem, 3/8" Diameter.	231.10
3327 90011	Insertion Handle	58.26

High-Low Thermometer

Registers maximum and minimum temperatures for any period and shows present reading.

- "U" shaped thermometer tube mounted on adjustable scales.
- Temperature range: -40° to 120 °F.
- To reset, press center button and hold down.
- 10-inch x 2-1/2-inch plastic case.

TAYLOR

ITEM NO.	PRODUCT	EACH
3542 54601	High-Low Thermometer	\$26.95



Cold/Dry Storage Wall Thermometer

- Painted metal frame mounts easily to flat surface.
- Easy-to-read even in poor lighting.
- Temperature range: -30 °F to 120 °F or -50 °F to 70 °F.
- Graduated in 2° increments. • 12 inches L x 2-1/2 inches W.

TAYLOR

ITEM NO.	PRODUCT	EACH
3542 1105	-30° to 120 °F	\$19.95
3542 1106	-50° to 70 °F	19.95



Wall Thermometer

- Plastic housing will not rust!
- 8-1/2-inch spirit filled glass thermometer is protected by recessed plastic housing.
- Temperature range: -20° to 120 °F.

ITEM NO.	PRODUCT	EACH
A692 30041	Wall Thermometer	\$6.53



Large Dial Wall Thermometer

- Temperature range: 0 °F - 100 °F (-17 °C - 37 °C)
- 13-1/4" diameter
- Vibrant color coded prep/dry storage temperature zones for proper food storage.
- Easy-to-read numerals with clear bezel



ITEM NO.	PRODUCT	EACH
3542 00211	Wall Thermometer	\$20.00

Refrigerator/Freezer Thermometer

- Completely enclosed horizontal, glass tube filled with non-toxic liquid.
- Dual scale, Fahrenheit and Centigrade, magnifying lens.
- Overall dimensions with rack hanging hooks: 5 inches x 1-3/4 inches.
- Dual range: -40° to 80 °F / -40° to 26.7 °C.



► 12 PER CASE.

ITEM NO.	PRODUCT	EACH
A692 00021	Refrigerator/Freezer Thermometer	\$13.01

Shake Down Thermometer

- Glass tube with aluminum case. • Accurate to ±1% of full range.
- Contains permacolor as a non-toxic substitute for mercury.
- Gradations and numbers will not fade or scratch and can be read in low light.



► 12 PER CASE.

ITEM NO.	PRODUCT	EACH
3542 41221	-50° to 120 °F	\$19.95
3542 4632	0° to 220 °F	19.95

Hot Water Thermometer

- Protective 15-inch long hardwood frame surrounds glass tube thermometer.
- Range: 10° to 220 °F. Accurate to ±2°.



ITEM NO.	PRODUCT	EACH
3849 03591	Hot Water Thermometer	\$57.85

Disposable Thermometer Probe Wipes

HACCP probe wipes for use in sterilizing thermometers between each use.

- For any thermometer with a probe, simply swab the metal section with a thermometer wipe for easy sanitizing.
- Anti-bacterial thermometer probe wipe helps eliminate cross-contamination when taking food temperatures.
- Ideal for promoting food safety. • 70% isopropyl alcohol wipes.
- 100 single use wipes per box. Individually packaged.
- Wipe dimensions: 2-5/8 inches L x 1-1/4 inches W.



► 100 WIPES PER BOX - 10 BOXES PER CASE.

ITEM NO.	PRODUCT	BOX
3542 00205	Disposable Probe Wipes	\$6.95



Wrist strap included.

Infrared Non-Contact Thermometer

Use a non-contact thermometer while cooking, receiving shipments or ensuring uniform storage temperatures.

- Trigger operated laser measures the temperature of the targeted surface.
- Measures in either °F or °C.
- Auto switch off.
- 4:1 distance to spot ratio.
- Temperature range -25° to 400 °F with an accuracy of ± 2 °F.
- Carrying pouch with wrist strap available.
- NOT CALIBRATABLE.
- Uses 9 V battery (included).

NOTE: Factory repair service is not available.

▶ SEE PAGE 566
For Replacement Batteries

ITEM NO.	PRODUCT	DIMENSIONS	EACH
A692 00011	Non-Contact Thermometer	6" x 4" x 1-1/2"	\$94.93

Infrared Thermometer



Using an infrared thermometer is the safest way to measure surface temperatures of hot, hard to reach, electrically energized or moving objects.

- 8-Point Class II Laser, enabled while measuring.
- Auto Shut-off after 15 seconds of non-use.
- Temperature Range: -76° to 932 °F/ -60° to 500 °C.
- LCD with Backlight (always on while measuring).
- 12:1 Distance to spot ratio.
- Dimensions: 1-4/5 inches x 5-3/5 inches x 7-3/10 inches (46 mm x 143 mm x 184.8 mm)
- Uses 2 AAA batteries (included).



▶ SEE PAGE 566
For Replacement Batteries

ITEM NO.	PRODUCT	F.O.B. FACTORY EACH
3098 22091	422 Infrared Thermometer	\$152.93

Non-Contact Forehead Infrared Thermometer



Ensures accurate and stable body temperature readings.

- Selectable Celsius or Fahrenheit modes.
- Selectable Body, Surface or Room modes.
- Automatic power off and data hold.
- Body mode range: 89.6° F to 109.4 °F/32.0° to 43 °C
- Surface mode range: 32° to 140 °F/0° to 60 °C
- Room mode range: 32° to 104 °F/0° to 40 °C
- Requires 2 - 1.5 V AA batteries. Not included.



Certified by:



1-1/5" to 2" (3 - 5 cm)

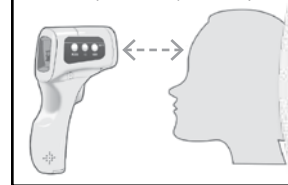

▶ SEE PAGE 566
For Batteries

ITEM NO.	PRODUCT	EACH
L222 00011	Forehead Thermometer	\$112.95

Clinical Thermometer

Used to calibrate non-contact thermometers.



ITEM NO.	PRODUCT	EACH
L268 00011	Clinical Thermometer	\$24.95

THERMOMETER CALIBRATION

In order to be in compliance with HACCP regulations we recommend the following thermometers be calibrated or calibration verified. Please follow the manufacturers procedures when calibrating all thermometers. Accuracy will be improved when calibrating to a temperature close to that measured. Always calibrate using a known temperature source (NIST traceable certified thermometer or instrument). Calibration should be performed on a regular basis as indicated by the table to the right.



NEED ASSISTANCE?



Our experienced customer service representatives are available to answer your questions, find the products you are looking for, check product availability, as well as take your order.

800-456-5624

* Tel-Tru Manufacturing Company recommends: Thermometers used daily should be checked daily to verify their accuracy. The method of checking thermometer accuracy should be in comparison to instruments whose accuracy is also verified and documented as traceable to the National Institute of Standards and Testing (NIST).; A known temperature source should be used which is stable, consistent and whose accuracy may be documented as traceable to NIST. Due to typical standard tolerances of error in various temperature measurement instruments the calibration verification check and recalibration (if necessary) be done at a temperature that is equal to or reasonably close to the critical limit for monitoring a critical control point.

** Calibration must be done at O.E.M. Refer to manufacturer instructions for return shipping information to manufacturer.

THERMOMETER CALIBRATION

BI-METAL POCKET		
ITEM NO.	RECOMMENDED	HOUR
3327 0044	Yearly*	
3327 0050	Bi-Monthly	60
3327 0225	Yearly*	
3327 02751	Weekly	36
3327 1050	Bi-Monthly	60
3327 1225	Weekly	36
3327 15531	Daily	8
3327 15541	Daily	8
3327 15591	Daily	8
3327 18001	Weekly	36
3327 23001	Weekly	36
3327 24001	Weekly	36
3327 2456	Weekly	36
3327 3606	Weekly	36
3327 3667	Weekly	36
3327 43301	Weekly	36
3327 83001	Weekly	36
3542 9621	Daily	8
3542 92221	Daily	8
DIGITAL POCKET		
ITEM NO.	RECOMMENDED	HOUR
E542 59091	Monthly	90
3098 0450	Monthly	90
3443 1051	Monthly	90
3542 41211	Monthly	90
3542 98671	Monthly	90
3611 00441	Monthly	90
4599 00071	Monthly	90
4599 10401	Monthly	90
4599 10501	Monthly	90
4599 10631	Monthly	90
DIGITAL HAND-HELD		
ITEM NO.	RECOMMENDED	HOUR
3098 51321	Yearly**	200
3098 01131	Yearly**	200
A692 90941	Yearly**	200
A692 00181	Yearly**	200
INFRARED DIGITAL		
ITEM NO.	RECOMMENDED	HOUR
A692 00011	Yearly**	200
3098 22091	Yearly**	200
L222 00011	Yearly**	200



Tel-Tru Check-Set Calibrators, 3-Inch Stem or Longer



Built-in tool makes adjustments fast and easy!

- Insert 3-inch or longer stemmed thermometer with a 3/8-inch, 7/16-inch or 5/8-inch hex calibration nut into the calibrator and twist. Also, please note the hex key is only for those models with 0.125-inch, 0.150-inch, 0.187-inch well insert.
- Verifies the accuracy of any stem dial thermometers and other temperature devices.
- Each unit serialized and certified traceable to NIST. • Accuracy is ± 0.02 °F. • Weight: 9 pounds (4 kg).
- Heavy-duty stainless steel housing. • No batteries required. • 5-foot grounded power cord. • 115 V.
- Check-Set IV (D) has multi-probe receptacles to calibrate all digital and bi-metal thermometers.
- Dimensions: Check-Set I Hot: 11 inch x 6-5/8 inches x 3-1/8 inches.
All other Models: 8-3/4 inches x 8-7/8 inches x 4-1/4 inches.

Check-Set II (C) and Check-Set IV (D) have multiple points of calibration so you can calibrate closer to the temperature points you use in actual applications – increasing the accuracy of your thermometers!

NOTE: Additional stem well sizes available as accessory to use with 3327 00281, 3327 0037 and 3327 03101. SEE BELOW.

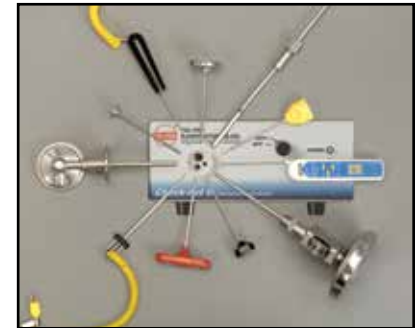

ITEM NO.	PRODUCT	SETPOINT	FITS PROBE DIAMETERS	F.O.B. FACTORY EACH
3327 6889	A. Check-Set I Hot.	160 °F	Up to 0.150".	\$1,132.43
3327 00281	B. Check-Set I Cold.	40 °F	0.125" 0.150" 0.187".	1,247.59
3327 00371	C. Check-Set II	40 °F/160 °F.	0.125" 0.150" 0.187".	1,701.82
3327 03101	D. Check-Set IV.	40 °F/150 °F/161 °F/175 °F	0.187" 0.250" 0.375".	2,411.44

NOTE: Thermometers are sold separately.



Scan this QR code with your mobile device to watch a video about Check-Set IV.

Well-Inserts

ITEM NO.	PRODUCT	EACH
3327 00311	Well Insert for Probe Diameter 0.156"	\$157.42
3327 00321	Well Insert for Probe Diameter 0.375"	157.42
3327 00221	Well Insert for Probe Diameter 0.500"	157.42
3327 00331	Well Insert for Probe Diameter 0.750"	157.42



Glass Calibration Thermometer

Certified precision instrument used to calibrate both digital and bi-metal thermometers.

- Glass body with gradations and numbers that will not fade or scratch and has a yellow back for easy reading.
- Mercury is encapsulated with Teflon® to contain the mercury in case of breakage. Non-mercury filled model available.
- Certified at 32°, 122° and 212 °F; ranges: 0 °F with 1° divisions.
- NIST traceable certificate of calibration with each thermometer.

Black, plush-lined protective carrying case included with item# 3345 2521.



ITEM NO.	PRODUCT	RANGE	EACH
3345 2521	A. Certified Calibration Thermometer (NOT for Use in California)	0° to 212 °F	\$330.85
3345 12301	B. Certified Calibration Thermometer* (For Use in California) Contains NO Mercury	0° to 230 °F	294.55

*Carrying case not included.

Single-Use, In-Transit Temperature Recorder

Easy-to use, portable, self-contained temperature recorder provides permanent records.

- An inexpensive and reliable way to monitor conditions during storage or transportation of temperature sensitive products. Battery powered, it generates a permanent strip-chart record of temperature conditions; the receiver simply removes the chart to review the temperature history of the shipment.
- Temperature range: -20° to 100 °F/-29° to 38 °C. • Simple to operate.
- NIST traceable calibration. • Visible start-up verification. • Available in 10 and 40 day charts.
- Dimensions: 6-1/2 inches L x 2-3/5 inches W x 3-1/2 inches H. • Weight: 10.5 ounces.



ITEM NO.	PRODUCT	EACH
3529 01101	Ten Day	\$15.56
3529 01401	Forty Day	15.56

Temprecord Temperature Data Loggers

For monitoring perishable or temperature-sensitive products in transit or as part of the cold chain.

- Fully welded food grade plastic case. • FDA compliant. • Recyclable.
- Case Protection Waterproof to IP67 and/or Nema 6.
- Manganese Dioxide Lithium (3.0 V) battery. Enclosed in logger.
- Compliance made easy with automated PDF report generation. Use speed-buttons from TempWrite software to: Save as TempWrite *.TWD files; Save as *.PDF files; Export to MS Excel; E-mail or print.

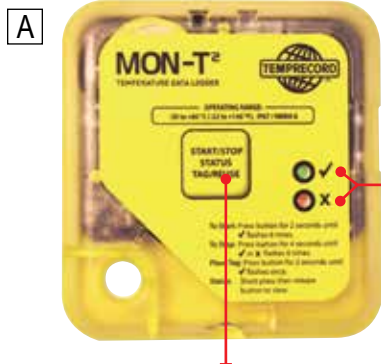

Push button feature allows user to 'Start' or 'Stop' data logger in the field. Also allows placement of tags. Functionality of the Push Button can be enabled or disabled through TempWrite software.

A. MON-T² Economy Logger

Ideal for transportation!

- 16K non-volatile memory.
- Temperature accuracy: 1 °F/0.5 °C.
- Case range: -22° to 140 °F/-30° to 60 °C.
- Display resolution 0.1 °C/0.1 °F
- No traceable calibration certificate available.
- Sample capacity: 16,384 samples.
- Recording duration: 8.8 hours (up to 12 months).
- Easily download data using Temprecord Reader Interface.
- Dimensions: 3 inches L x 2-7/8 inches W x 5/8 inches D (77-1/2 mm L x 73-1/2 mm W x 14 mm D).
- Push button start/stop/status.
- Weight: 1.62 ounces (55 g)
- Compatible with Windows 7, 8 and 10.
- Warranty: 12 months or 200,000 samples.

LED Status Indicators: By simply pressing button to view status, the ✓ (green) and ✗ (red) LED indicators allow instant confirmation of recorded data being within or outside of specified upper and lower temperature range. When button pressed and released, the green LED will flash three times if recorded temperature is within limits or the red LED will flash three times if recorded temperature is outside limits.

C. USB Reader Interface

Required to read/download data from loggers.

- Connect to computer via USB port.

D. Optional Plastic Logger Holder

Allows for mounting logger to wall or surface.

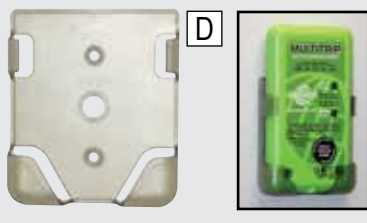

ITEM NO.	PRODUCT	EACH
F756 00021	A. MON-T2 Economy Logger	\$73.01
F756 14161	B. MULTITRIP Logger (No Probe).	229.42
F756 31311	MULTITRIP Logger (With Probe)	394.06
F756 14171	C. USB Reader Interface.	195.08
F756 21831	D. Plastic Logger Holder	27.04

B

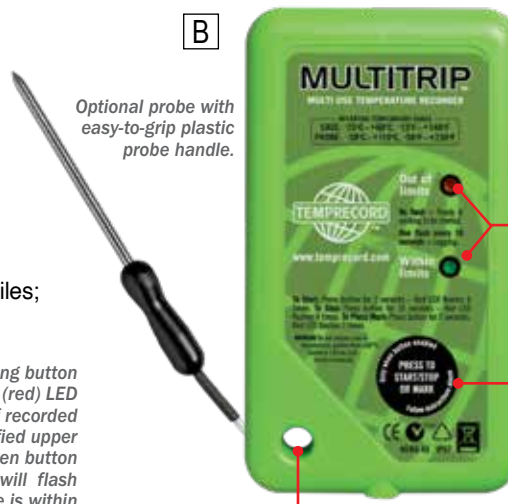

Optional probe with easy-to-grip plastic probe handle.

LED Status Indicators: 'Within limits' (Green) LED Indicator and 'Out of limits' (Red) LED Indicator allow instant confirmation of recorded data being within or outside of specified upper and lower temperature range.

Push Button feature allows User to 'Start' or 'Stop' data logger in the field. Also allows for the setting of indication 'Markers' during data recording for future reference. Functionality of the Push Button can be enabled or disabled through TempWrite software.

Fully moulded and ultrasonically welded retaining hole for easy securing of the data logger within different environments.

B. MULTITRIP Logger

Available with or without plastic handle probe.

- 8K non-volatile memory.
- Calibrated temperature accuracy: 0.35 °F/0.2 °C.
- Case range: -13° to 140 °F/-25° to 60 °C.
- Display resolution: 0.01 °F/0.01 °C.
- 3-Point Calibration built into logger: Superior accuracy with no need for corrections or calculations to be applied to downloaded data; avoids human data entry errors.
- Traceable Calibration Certificate included.
- Sample capacity: 7,935 samples.
- Recording duration: 4.4 hours (up to 2 years).
- Push button start/stop or mark.
- Weight: 2.85 ounces (81 g).
- Dimensions: 5-1/8 inches L x 2-7/8 inches W x 5/8 inches D (129 mm L x 73-1/2 mm W x 14 mm D).
- Compatible with Windows XP, Vista and Windows 7
- Warranty: 12 months on logger; 24 months on battery.

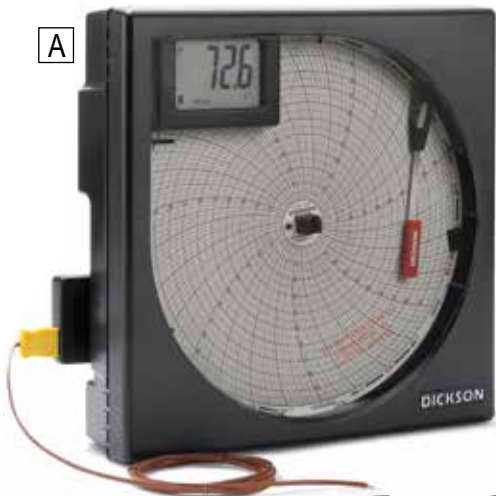

8-Inch Temperature Chart Recorder with Alarm

- Rugged black ABS case, polycarbonate door with aluminum dial.
- Includes AC adapter, red pen, four AA batteries, quick start guide and 4-foot bead-wire probe.
- User selectable temperature ranges: -50° to 50 °F/°C, -20° to 20 °F/°C, 0° to 100 °F/°C, 0° to 150 °F/°C, 0° to 250 °F/°C, 0° to 500 °F/°C, 0° to 1,000 °F/°C, 0° to 2,000 °F.
- 120 to 240 VAC, 12 VDC (INTL fittings available); optional AC adapter available.
- Keypad functions include power on/off, pen home and alarm.
- Mounting options include free standing or wall mounted. • 6-foot power cord.
- Charts sold separately. • Chart rotation speed: 24 hours, 7 day or 31 day.
- Dimensions: 3-1/10 inches L x 9-1/5 inches D x 9-1/5 inches H.
- Alarm types are audio/visual on high/low limits. • Battery Backup: Four AA Batteries.
- Temperature Accuracy: ± 1.8 °F from -22 °F to 122 °F 3.8F remaining (±1 °C from -30° to 50 °C 2.1C remaining). • Powers unit for up to 3 days. 72 hours battery life (back-up only).

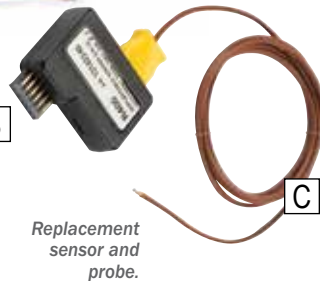

► SEE PAGE 566
For Replacement Batteries

NOTE:
Other probes
available.
Call for details.

ITEM NO.	PRODUCT	F.O.B. FACTORY EACH
3368 10081	A. Temperature Chart Recorder	\$777.01
3368 04001	B. Replacement Sensor	207.65
3368 1013	Replacement Bead Wire Probe	58.75
3368 0222	Replacement Red Pens (6-Pack)	78.50
3368 01571	Optional AC Adapter	46.15
3368 0411	8" Chart, 24-hr, -50° to 50 °F/C (60 per Pack)	72.27
3368 0410	8" Chart, 24-hr, 0° to 100 °F/C (60 per Pack)	72.27
3368 0414	8" Chart, 7-Day, -50° to 50 °F/C (60 per Pack)	72.27
3368 0412	8" Chart, 7-Day, 0° to 100 °F/C (60 per Pack)	72.27

3-Inch Compact Reusable Recorder

The small recorder big on flexibility.

- Easy user calibration.
- Tamper seal strips available for chart reading integrity.
- °F/°C switchable; temperature ranges: 4° to 50 °F/-15° to 10 °C.
- Recording Times: 24-hour or 7-day chart.
- Dimensions: 3-7/10 inches L x 3-7/10 inches W x 2-1/5 inches D.
- Accuracy: ±2 °F (±1 °C) over full scale.



- Includes 1 AA battery and pen.
- Dimensions: 3 inches L x 2-7/8 inches W x 5/8 inches D (77-1/2 mm L x 73-1/2 mm W x 14 mm D).

► SEE PAGE 566
For Replacement Batteries

ITEM NO.	PRODUCT	F.O.B. FACTORY EACH
3368 0377	24-Hour and 7-Day, 4° to 50 °F Temperature Recorder	\$351.92
3368 0303	24-Hour Charts for 3368 0377 (Box of 60)	72.27
3368 0304	7-Day Charts for 3368 0377 (Box of 60)	72.27
3368 0222	Replacement Red Pens (6-Pack)	78.50

4-Inch Temperature Chart Recorder

Ideal for food processing environments.

- Precise spiral-wound bi-metallic strip transducer temperature sensor.
- Temperature ranges: -22° to 122 °F/-30° to 50 °C.
- 1-pt. NIST Traceable Certificate of Calibration available through manufacturer.
- Accuracy: ± 2% full scale. • Recording times: 7-day or 24-hour.
- Dimensions: 7 inches H x 5-1/2 inches W x 2-1/2 inches D.
- Weight: 10.4 ounces.
- Includes 1 AA battery, pen, and instruction manual.



► SEE PAGE 566
For Replacement Batteries

Real time temperature.

Flip-up pen arm for faster pen and chart changes.

4-inch chart offers 2-1/2 times the readable chart area of a 3-inch chart.

ITEM NO.	PRODUCT	F.O.B. FACTORY EACH
3368 00041	Temperature Recorder w/Digital Display	\$363.58
3368 02065	7-Day Chart, -22° to 122°F (Box of 60)	72.27
3368 02055	24-Hour Chart, -22° to 122°F (Box of 60)	72.27
3368 0222	Replacement Red Pens (6-Pack)	78.50



Quick and Easy Strip Door Installation — Without the Tools!



► **SEE PAGES 540-542**

PLANT REMODELING

FIND IT FAST

Strip Doors and Accessories	540-542
Air Doors	543
Curtains and Roll-Up Doors	543-544
Flexible Doors	545
Traffic Doors	546-548
Personnel and Interior Doors	549
Cold Storage Doors and Parts	550-551
LED Hybrid Fixture	552
Shatterproof Light Bulbs	552
Fluorescent Low Bay Fixtures	553
Washdown Light Fixtures	554-555
LED Lighting Fixtures	555
LED Emergency Lighting	556
Ceiling Panels and Systems	557-558
Stainless Steel Corners	558
Wall Coverings and Accessories	558-559
Floor Coatings	560
Lockers, Bollard Covers and Benches	561
Banner Stakes	562



Template Kit

Simplifies the process of cutting bulk roll material into individual door strips.

- Fabricated of non-slip 1/4-inch acrylic.
- Dimensions are permanently etched directly on the template.
- Special drill bit bores a perfectly round hole into material to prevent tearing.
- Kit includes template, drill bit and marker.



NOTE:
We recommend mounting these doors 1 foot above door opening to eliminate tearing strips with tall loads.

ITEM NO.	PRODUCT	F.O.B. FACTORY EACH
G368 2700	Quickmount™ Template Kit	\$61.51

All strip doors are designed to mount on either the inside or outside wall above the door opening with a minimum of 5" overlap on each side.

How to figure the AMOUNT OF STRIP NEEDED

1. **Measure** the opening in feet (WxH).
2. **Add** 1 foot to the door height and width, depending on space available.
3. **Calculate** using the following formula in feet:
 - 6" Strips — (W x H) x (1-1/2) x (2)
 - 8" Strips — (W x H) x (1-1/2) x (1-7/10)
 - 12" Strips — (W x H) x (1-1/2)



8-inch PVC Strips
50% overlap.



8-inch PVC Strips
100% overlap.

Aluminum HD Strip Door Mounting Hardware

- 70% faster installation time – 90% faster strip replacement time.
- One-piece, heavy-duty 1/4-inch thick aluminum construction won't rust or corrode.
- Use 3/8-inch bit to drill holes in strip material or template kit shown on facing page.
- 2-inch sections of mounting hardware snap together. • Includes installation instructions.



NOTE: Purchase Quickmount™ Hardware and Strips and get Quickmount™ Template for FREE! CALL FOR DETAILS.

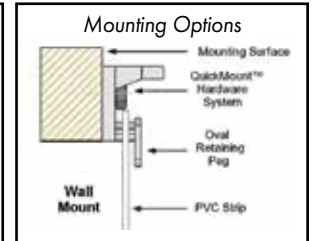
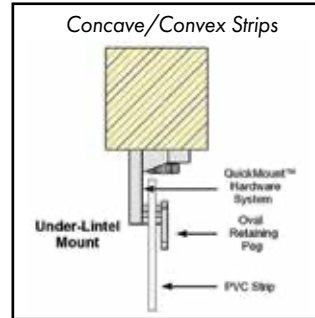

Scan this QR code with your mobile device to watch a video showing the difference between the door mounting hardware options.

ITEM NO.	PRODUCT	F.O.B. FACTORY EACH
G368 27021	2" Section Mounting Hardware	\$39.04

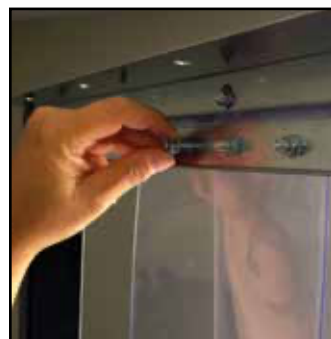

Bolt-On Universal Galvanized Hardware

A heavy-duty mounting system used when maximum strength and durability are required.

- Each section comes complete with retaining plates and lock-nuts to secure the strips.
- Made from heavy-duty galvanized steel for ultra-heavy traffic applications.
- Strips held in place by galvanized steel retaining plates and lock nuts.
- Can be mounted on the face of the wall or under the lintel.



▶ SEE PAGES 541-542 For Door Strips

ITEM NO.	PRODUCT
G368 00031	3 ft. Section
G368 00071	4 ft. Section

CALL 800-456-5624 for pricing and information.

Clear Antibacterial Door Strips

Antibacterial properties are blended into the compound to inhibit the growth of bacteria — will not wash out!

- Proven to kill 99.9% of bacteria like e-coli, staph and pneumonia on the surface of the PVC strip.
- Made of clear, high-quality durable vinyl, resists scratching and remains pliable in cold.
- Effective airflow, dirt and moisture block. • Can be used in walk-ins and food storage areas.

MADE IN USA

SPECIAL ORDER ITEM

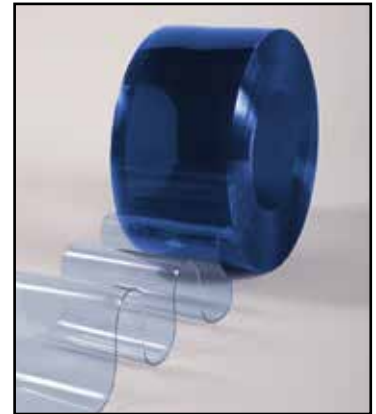

ITEM NO.	COLOR	WIDTH	LENGTH	THICKNESS	ROLL
G368 10381	Clear	6"	300 ft.	0.080"	\$343.60
G368 20471	Clear	8"	150 ft.	0.080"	314.01
G368 20481	Clear	12"	100 ft.	0.120"	471.58

Bulk PVC Colored Door Strips, For Applications Above 32 °F Only

ITEM NO.	COLOR	WIDTH	LENGTH	THICKNESS	F.O.B. FACTORY ROLL
G368 2801	Anti-Insect Yellow Durarib™	12"	150 ft.	0.110"	\$624.40
G368 2802	Opaque Black	8"	300 ft.	0.080"	503.55
G368 2803	Safety Orange	8"	300 ft.	0.080"	564.03
G368 2804	Safety Orange	12"	300 ft.	0.120"	831.76
G368 2805	ScreenFlex™ Bronze	8"	300 ft.	0.080"	533.14
G368 2806	ScreenFlex™ Red	8"	300 ft.	0.080"	533.14
G368 2807	ScreenFlex™ Green	8"	300 ft.	0.080"	533.14



Quickstrip Perforated Pre-Punched PVC Strip Door Material

Fastest, most convenient way to replace worn strips.

- Perforated edge allows you to neatly remove individual strips for quick and easy installation.
- Each strip is pre-punched on 2-inch centers to fit most studded mounting hardware — no tools needed.

SPECIAL ORDER ITEM

MADE IN USA

ITEM NO.	COLOR	WIDTH	LENGTH	STRIPS/ROLL	THICKNESS	F.O.B. FACTORY ROLL
G368 2902	Standard Smooth	8"	84"	7	0.080"	\$126.74
G368 2901	Standard Durarib™	8"	96"	9	0.072"	197.80
G368 2900	Standard Smooth	8"	96"	9	0.080"	174.15
G368 2903	Low Temp Reinforced	8"	84"	7	0.080"	142.18
G368 2904	Standard Smooth	8"	120"	7	0.080"	174.15
G368 2905	Standard Durarib™	8"	120"	7	0.072"	221.56
G368 2906	Standard Smooth	12"	120"	7	0.120"	361.31
G368 2907	Standard Smooth	12"	144"	6	0.120"	377.95
G368 2908	Standard Durarib™	12"	144"	6	0.110"	426.55



Perforated edge for quick and easy installation.



WHY REPLACE DOOR STRIPS?

- To reduce the transfer of contaminants between work areas.
- Old strips harbor bacteria in the cuts and cracks that form as a result of impact. • Worn and scratched strips cut down on visibility and safety.
- Maintain Temperature Integrity — Worn out strips have holes and cracks which allows cold air to escape and warm air to infiltrate.

E-Z Hang™ Clear Vinyl Door Strips

The BEST door strip program available!

- Able to withstand heavy traffic including forklifts.
- Made from a non-phthalate formulation.

NOTE: Other sizes available. CALL FOR MORE INFORMATION.

Standard Applications

Smooth — Clear

ITEM NO.	WIDTH	LENGTH	THICKNESS	ROLL
G368 5092	6"	300 ft.	0.060"	\$302.34
G368 2102	8"	150 ft.	0.060"	268.97
G368 2104	12"	100 ft.	0.120"	396.95
G368 2106	16"	100 ft.	0.160"	670.63

Ribbed — Clear

ITEM NO.	WIDTH	LENGTH	THICKNESS	ROLL
G368 2107	8"	150 ft.	0.072"	\$283.12
G368 2108	12"	150 ft.	0.110"	624.40
G368 2109	16"	100 ft.	0.144"	731.11

Below 32° Applications — Low-temp strip for freezer applications.

Smooth — Clear

ITEM NO.	WIDTH	LENGTH	THICKNESS	ROLL
G368 0092	8"	150 ft.	0.080"	\$283.12
G368 2112	12"	100 ft.	0.120"	441.99
G368 10311	16"	100 ft.	0.160"	739.31

Reinforced — Clear

ITEM NO.	WIDTH	LENGTH	THICKNESS	ROLL
G368 10321	6"	300 ft.	0.060"	\$314.01
G368 10331	8"	300 ft.	0.080"	548.59
G368 10341	12"	200 ft.	0.120"	739.31

Ribbed — Clear

ITEM NO.	WIDTH	LENGTH	THICKNESS	ROLL
G368 10351	8"	150 ft.	0.072"	\$313.90
G368 10361	12"	150 ft.	0.110"	670.63
G368 10371	16"	100 ft.	0.144"	815.24



Standard Smooth Clear PVC Strip Curtain

- Versatile, economical material for cooler temperatures or ambient applications.
- Temperature range: +150 °F to -10 °F.
- Install strips faster, easier and without tools with the exclusive QuickMount HD aluminum mounting hardware.



▶ SEE PAGE 540
For QuickMount™ HD Mounting Hardware



ITEM NO.	DOOR SIZE WIDTH X HEIGHT	STRIP SIZE		OVERLAP%	F.O.B. FACTORY
		WIDTH	GAUGE		ROLL
G368 0027	3' x 7'	6"	0.060"	0.67	\$168.21
G368 0026	4' x 7'	6"	0.060"	0.67	228.58
G368 0025	4' x 8'	6"	0.060"	0.67	228.69
G368 0024	3' x 7'	8"	0.080"	0.5	152.77
G368 0023	4' x 7'	8"	0.080"	0.5	213.25
G368 0022	4' x 8'	8"	0.080"	0.5	228.58
G368 0021	5' x 7'	8"	0.080"	0.5	244.03
G368 0020	5' x 8'	8"	0.080"	0.5	274.81
G368 0019	6' x 7'	8"	0.080"	0.5	304.51
G368 0018	6' x 8'	8"	0.080"	0.5	350.73
G368 0017	8' x 8'	8"	0.080"	0.5	412.29
G368 0016	8' x 8'	12"	0.120"	0.67	503.55
G368 0015	8' x 10'	12"	0.120"	0.67	609.07
G368 0014	10' x 8'	12"	0.120"	0.67	624.40
G368 0013	10' x 10'	12"	0.120"	0.67	761.89
G368 0012	10' x 12'	12"	0.120"	0.67	899.37
G368 0011	12' x 12'	12"	0.120"	0.67	1,066.45
G368 0010	12' x 14'	12"	0.120"	0.67	1,219.27
G368 0009	14' x 12'	12"	0.120"	0.67	1,248.86
G368 0008	14' x 14'	12"	0.120"	0.67	1,401.79



Berner™ International Air Doors

FDA, USDA, NSF and UL listed.

- Galvanized steel fan wheels and housings.
- Aluminum airfoil shaped directional vanes.
- Aluminum base frame.
- White aluminum or stainless steel housing.
- Keyhole slots in backplate for quick wall mounting.
- Licensed to bear AMCA Air Performance Seal.
- Five year parts warranty.
- Perfect for customer entry doors, receiving doors, patio doors, dock doors, walk-in coolers, drive-up windows and concession windows.

NOTE: Also available in ambient, electric heat, steam heat and hot water heat.

CALL 800-456-5624
FOR PRICING AND INFORMATION



F.O.B. FACTORY



Ask about FREE SHIPPING.

ORDER AIR DOORS

Please have the following information available.

Exact finished opening size (inches): Width _____ Height _____ Controlling: Temperature Dust Insects Fumes

Voltage Requirements: 110 220 440 Door Usage: Run for short periods On constantly Start and run when door opens

Phasing: Single Three (requires starter panel) Mounting Location: Interior Exterior Opening: Cooler/Freezer Dock Service Retail Other

Washdown Curtain Walls and Clean Curtains

Reduce process line down time during washdown cycles.

- Custom sized to meet any cleaning or sanitation requirement.
- Constructed with non-porous PVC material.
- Prevent cross contamination between processing lines.
- Wash spray can hit all surfaces.
- Improves plant sanitation.



Open trolley design to prevent bacteria from forming.



CALL 800-456-5624
FOR PRICING AND INFORMATION

ITEM NO.	PRODUCT	F.O.B. FACTORY
B399 2100	Washdown Curtains	CUT TO
B399 1059	Clean Curtains.	SIZE



Climate Curtains

- Double-paneled 18-ounce coated vinyl curtain walls lined with Thinsulate™ Ultra insulation from 3M™.
- Flexible, climate control isolation for a variety of applications including freezer and cooler areas, loading docks, food processing lines and warehouse separation.
- Thermal valance and floor sweep.



Overlapping panel design.



ITEM NO.	PRODUCT
B399 1001	Climate Curtains

F.O.B. FACTORY
CUT TO
SIZE



Mesh and Vinyl Roll-Up Doors

Complete kit ready to install!

Benefits:

- Significantly reduces heat loss while allowing light into work areas.
- Keeps out unwanted pests, birds and intruders.
- Controls airborne contaminants and improves building appearance.
- Mesh allows fresh air to flow through for comfort and productivity and helps meet FDA and AIB requirements.
- Three year warranty — one year warranty on motor drive mechanism.

Features:

- High speed: up to 36 inches per second.
- Low maintenance: no cables, wheels, springs or sewn construction.
- Wind load rated: 45 mph wind load*.
- Durable: fiberglass windbars won't bend or break. Automatically resets after impact.
- Quick and easy installation: upper box completely assembled in factory.
- Multi-season: exchangeable panels available in mesh, clear and solid vinyl.
- Fire resistant: meets NFPA-701 and CSFM standards for flame retardancy.
- Resistant to all ultraviolet rays and is rot, tear and mildew resistant.

Available Options:

- Vinyl Door color options: gray, black, blue, beige, green, red, yellow, orange and white.
- Mesh Door color options: gray, black, almond, royal blue, spruce green, yellow and red.
- Operations include: manual chain hoist, 18 inches per second (in tube motor), 28 inches per second and 36 inches per second (external mounted motor).
- Various Control Options: hardwired and RF available to meet your specific application.
- Outside face mount or inside projection mount available.

* Wind load tested on a 10-inch x 12-inch solid vinyl roll-up door per ANSI/DASMA 108-2002.

CALL 800-456-5624 FOR PRICING AND INFORMATION



Bug and bird mesh door.



High-speed vinyl roll-up door.
Also available:
vinyl roll-up doors for extreme conditions.

ITEM NO.	PRODUCT	F.O.B. FACTORY
B399 0037	Bug and Bird Mesh Door	CUT TO
B399 1325	High-Speed Vinyl Roll-Up Door	SIZE



Spring assist.



Side seal.



Our experienced customer service representatives are available to answer your questions, find the products you are looking for, check product availability, as well as take your order.

NEED ASSISTANCE?

800-456-5624

Flexible Airguard® Doors



FLEXIBLE DOORS

Series 100 Doors Models Numbers 100E and 100CE

- Meets USDA requirements.
- 45-ounce, heavy-duty, abrasion-resistant vinyl coated nylon.
- Large 30 x 14-inch vision panel made from shatterproof polycarbonate.
- Top mounted gravity actuated hinge provides completely automatic operation. Opens instantly upon contact and closes automatically by gravity.
- 48-inch heavy-duty, 1/8-inch thick Kydex® impact plates mounted front and back of each door.
- Available in green only.

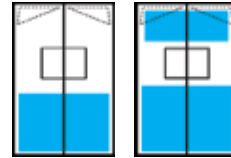

Model 100E (photo) Model 100CE



UNIFLEX 240 PVC Door Models Number 240PVC

- Constructed of two layers of 0.12-inch PVC heat welded together to a thickness of 0.24 inches and textured embossed finish.
- 15 x 14-inch clear vinyl window centered in each panel.
- Meets USDA requirements.
- Top mounted gravity actuated hinge provides completely automatic operation. Opens instantly upon contact, then closes automatically by gravity.
- Colors: navy, royal blue, chocolate brown, medium brown, forest green, red, metallic gray and black.

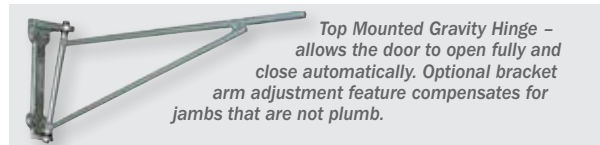

300 Belted Door Models Number 300 Belted

- For heavy use forklift and/or freezer applications down to -30 °F.
- Wiper seals are provided at bottom and top.
- Balloon seals provided at jamb edge of each door.
- Window centered in each panel 15 inches x 14 inches.
- Constructed of two layers of abrasion-resistant, two-ply “belting” material bonded together.
- Top mounted gravity actuated hinge provides completely automatic operation. Opens instantly upon contact, then closes automatically by gravity.
- Available in green only.

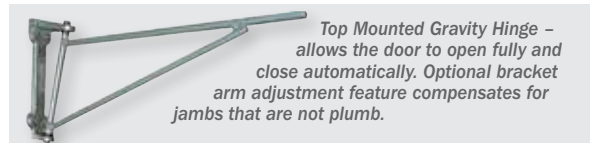

973 Standard Forklift Doors Models Number 973

- NOT for freezer applications.
- Constructed of 0.16-inch thick, PVC door body with a two-ply, vinyl coated nylon bracket pocket.
- Top mounted gravity actuated hinge provides completely automatic operation. Opens instantly upon contact, then closes automatically by gravity.
- Extra-large viewing area allows clear visibility and maximum safety.
- Balloon seals provided at jamb edge of each door, top and bottom wipers.
- Textured vinyl impact plates on both sides increases strength and durability of door.
- Available in black or red.

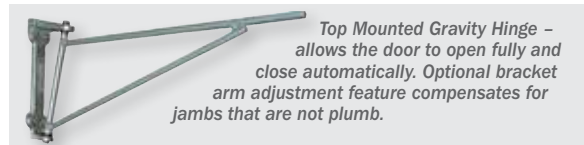

ORDER FLEXIBLE AIRGUARD® DOORS Please have the following information available.

REMEMBER: Check your local building codes and/or with your local USDA inspector when buying products for your remodeling job.

Exact finished opening size (inches): Width _____ Height _____ **Color:** _____ **Model:** 100E 100CE 240 300 973

Traffic: People Carts Other _____ **Temperature:** Inside _____ Outside _____

Insulated Traffic Doors

- Fully gasketed doors can be mounted on either wood or metal frames (not included).
- Large polycarbonate windows are virtually scratch-resistant.
- Optional bumpers and impact plates 6 inches to 42 inches high, available.
- V-cam hinge; 1-inch diameter steel hinge post and steel leading edge post is molded in the door and runs the full length of panel.
- No gap seams; impervious to moisture, acids, petroleum products, or animal fats.
- XHD Retail Door (all stainless steel hardware) also available.
- Available in 14 colors: navy, royal blue, cadet blue, beige, chocolate brown, medium brown, jade, forest green, red, burgundy, white, cloud gray, metallic gray and black.



NOTE: Frames sold separately.

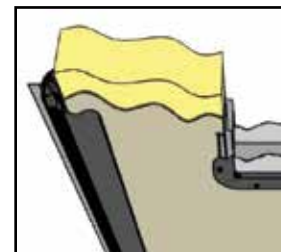

Ultra-high density, non-CFC urethane foam core.



Durulite double-action V-Cam hinge system.

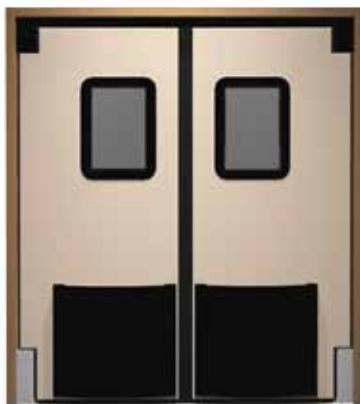

Medium-Duty Retailer Door

For use with people and cart traffic.

- One-piece molded 1/8-inch thick cross linked polyethylene outer skin over 1/4-inch urethane foam.
- Overall panel thickness: 1-1/2 inches.
- 8-1/2-inch lower hinge guards.
- Sizes up to 96 inches x 96 inches. Larger openings can be accompanied with swinging transom panel.
- R-FACTOR: 9.86



Heavy-Duty Standard Door

For use with people, carts and motorized cart traffic.

- One-piece molded 1/8-inch thick cross linked polyethylene outer skin over 1-3/8-inch urethane foam.
- Overall panel thickness: 1-7/8 inches.
- 11-inch lower hinge guards.
- Sizes up to 96 inches x 96 inches.
- R-FACTOR: 10.83



Ultra Heavy-Duty Industrial Door

For use with people, carts, motorized carts and forklift traffic.

- One-piece molded 1/4-inch thick cross linked polyethylene outer skin over 1-3/8-inch urethane foam.
- Panel thickness: 1-7/8 inches.
- 11-inch lower hinge guards.
- Sizes up to 120 inches x 120 inches. Larger openings can be accompanied with swinging transoms or double dutch panels.
- R-FACTOR: 10.83

ORDER TRAFFIC DOORS

Please have the following information available.

Exact finished opening size (inches):

Width _____ Height _____

Bumpers:

Standard 24" High Other _____

Kickplates: 24" Other _____

Model: Medium-Duty Heavy-Duty
 Ultra Heavy-Duty

Color: Red Royal Blue Beige Navy
 Cadet Blue Jade Medium Brown
 Chocolate Brown Metallic Gray
 Cloud Gray Forest Green
 Burgundy White Black

**CALL 800-456-5624 FOR
PRICING AND INFORMATION**



P-11 Plus Impact Traffic Door

For applications requiring an economically priced solution that is both durable and attractive.

- Includes 14 x 16-inch scratch-resistant clear acrylic window set in black rubber molding.
- 14 gauge steel back channel powder coated back. • 1/2-inch thick ABS frame with honeycomb core.
- 0.100-inch thick high impact thermoplastic exterior (both sides).
- Operates on a patented easy swing hinge system.
- Optional: impact plates, push plates, easy spring bumpers, lower hinge guards, various window shapes and sizes as well as flush style windows.
- Colors: black, red, fudge brown, navy, cloud gray, antique white, beige, royal blue, cadet blue, chocolate brown, medium brown, gray, metallic gray, forest green white and off white.



SRP 5000 Medium-Duty Traffic Door

Constructed of 1/2-inch thick stress relieved high-density polyethylene, textured to hide normal dents and scratches. For use with carts, pallet jacks and people.

- Includes 9 x 14-inch acrylic windows set in rubber molding.
- Can be custom designed to fit any plant, store or restaurant application.
- Doors can be mounted on either wood or metal jambs, frames not included. • Not gasketed.
- Back edge spine is a one-piece, continuous extruded 1/4 inch x 2-inch diameter anodized aluminum tube with flanges that radius the door panel for added strength and durability.
- Colors: chocolate brown, red, metallic gray, black, beige, white and cloud gray.



Big Foot Door Pull

- All aluminum one-piece construction.
- Easy installation, mounting hardware included.
- Hands-free operation.

Structural Steel Door Frames

Manufactured of tubular steel to fit your door opening. Shipped knocked-down in three easy to assemble pieces.

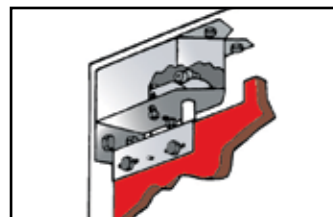

Classic "C" Hinge — can easily be adjusted after removing the cover and screws.



Back Spine — Heavy-duty "U" shaped fiberglass pultrusion further stiffens the spine for added strength and stability.

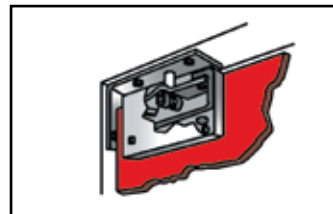

Classic "E" Hinge — gravity close hinge system mounts to the jamb with offset hardened steel cam and rollers.

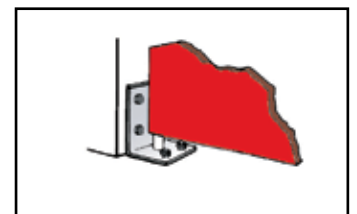

Heavy-duty bottom hinge pin stabilizes the panel in the frame.

ITEM NO.	PRODUCT	EACH
H565 00261	One Size	\$34.35

CALL 800-456-5624 FOR PRICING AND INFORMATION



SD2000 Light-Weight Aluminum Traffic Doors

For use with cart and people traffic only, no motorized traffic.

- Constructed with 0.063-inch anodized aluminum.
- Includes 9 x 14-inch acrylic windows wet in black rubber molding.
- Hinge system mounts to the jamb with offset cam system and hardened rollers.
- Can be custom designed to fit any plant, store or restaurant application.
- Doors can be mounted on either wood or metal jambs, frames not included.
- NOT for washdown. • Optional kickplates available.



F.O.B. FACTORY



Leading Edge — is formed in a diamond for vertical panel stiffness and edge protection.



Back Edge Spine — 1 inch thick by 5 inches wide back edge spine is reinforced with 3/8-inch plywood and capped with aluminum.



SST2000 Stainless Steel Traffic Doors

Custom made for any size opening! For use with cart and people traffic only, no motorized traffic.

- Available in single or double door styles.
- Constructed of 16 gauge, #4 brushed finish stainless steel.
- Includes 9 x 14-inch acrylic window set in rubber molding.
- Ultra Soft Touch™ assisted gravity hinge is hidden in the back spine.
- Low-maintenance, no unattractive upper panel cutouts or large corner hinge components visible.
- For added strength and durability, the entire length of the back panel is reinforced with one continuous piece of extruded aluminum that has flanges which wrap the door panel.
- Optional impact plates available.



F.O.B. FACTORY

ORDER TRAFFIC DOORS

Please have the following information available.

Exact finished opening size (inches):

Width _____

Height _____

Kick plate height: _____

Traffic:

People Carts Other _____

CR1400 Corrosion Resistant Urethane Door

Manufactured to withstand the most corrosive environments from saltwater, chemicals, detergents, chlorine, acid, to humidity and more.

- Constructed with a 1/8" thick outer skin of rotationally molded polyethylene with an ultra high density foamed-in-place core.
- The panel can retain its properties from 30°F to 100°F continuous service, and 140°F intermittent service with temperature differences of up to 40°F.
- The overall thickness of the panel is 1-3/4", yet weighs only 3.66 pounds per square foot, making it lightweight and easy to open.
- The sanitary surface never needs painting and cleans easily with soap and water.
- All doors come standard with a replaceable bottom sweep, and are available with a drop down seal. Full perimeter gasketing is available.
- The CR1400 has excellent insulation qualities with an EcoMate foamed-in-place NON-CFC urethane core. Ecomate insulation is designed to be environmentally friendly; it was awarded VOC (Volatile Organic Compound or SMOG) Exempt Status by the EPA.



Constructed with a 1/8" thick outer skin of rotationally molded polyethylene

Solid resin transfer molded door frame.

Many window options.

Ultra high density foamed-in-place core.

Every Door is CUSTOM MANUFACTURED to Your Exact Requirements.

CALL 800-456-5624 FOR PRICING AND INFORMATION

AVAILABLE IN 14 STANDARD COLORS





Single Door Sizes:
Rough Opening Fit
34" x 82"
38" x 82"
34" x 86"
38" x 86"

Double Door Sizes: Rough Opening Fit
67" x 82"
75" x 82"
57" x 86"
75" x 86"
75" x 98"

NOTE: Size includes framing, actual door will be 2 inches (height and width) smaller.

PVC Interior Doors

- Choose from insulated or non-insulated.
- Available in white only.
- For interior use only — light-weight, corrosion and mildew resistant.
- Internal steel reinforced sides.
- Double track felt sweeps on top, rubber sweeps on bottom.
- Available options: windows, kickplates, door closer, locking devices and insulation.



ORDER PVC INTERIOR DOORS
Please have the following information available.

Single Door Double Door **Door size:** Width _____ Height _____

Insulated Non-Insulated **Swing:** LH RH In/Out

Wall Type: _____ **Wall Thickness:** _____

Options: Windows Kickplates Door Closer Locking Devices

Required Hardware: _____

SHOP 24/7

bunzlpd.com

CHAT

Need Help?

Chat With Us

Online!

STAY CONNECTED WITH US:

f

t

You Tube

in

p

i

Where you can find out what's on sale, find updated product information, reviews and pricing.

PRICES ARE SUBJECT TO CHANGE • MINIMUMS MAY APPLY • VISIT WWW.BUNZLPD.COM FOR CURRENT PRICING.



Cooler and Freezer Cold Storage Doors

Custom designed doors to meet your individual needs.

Features:

- No wood in door. • FRP frame. • Chrome cam lift hinges.
- Heavy-duty chrome handle.
- Heated gasket prevents door from freezing closed.

Options:

- Inside casing and return jambs. • Locking devices.
- Meat rail provision. • Panic bar latching hardware.
- Door closer (manual or electric). • Optional window.
- Kick plates (stainless or aluminum).



Power and manually operated slide cooler/freezer doors are available as well as vertical lift doors.



SPECIAL
ORDER
ITEM



F.O.B. FACTORY

CALL 800-456-5624
FOR PRICING AND INFORMATION



ORDER COOLER AND FREEZER STORAGE DOORS

Please have the following information available.

Exact finished opening size (inches): Width _____ Height _____

Single Door Double Door

Swing: LH RH

Finish: White USDA Embossed Galvanized Steel Stainless Steel

Door Closer: _____ Window: _____

Frame: Standard (front face casing only) L-Shaped (front face casing, jamb)
 L-Shaped (front face casing, jamb, inside casing)

Wall type: _____ Wall thickness: _____

Temperature: Inside _____ Outside _____ Meat rail cut-out: Yes No

Sill: Flush High Diamond tread kickplate size (inches): Length _____ Height _____

ORDER REPLACEMENT HARDWARE

Please have the following information available.

Offset of door: _____
Many Offsets Available from Flush to 1-1/2".

Size of Replacement Part Needed: _____

Thickness of door: _____

Polished Chrome Reversible Cam-Rise Door Hinge

- Reversible, constructed of die-cast zinc with chrome finish.



Lift strap from flange and remove pin assembly.



Pop out cap. Turn strap 180°, reinsert strap.



Reposition strap into flange and replace cap.

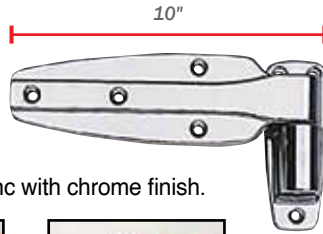

ITEM NO.	PRODUCT	EACH
3687 00501	23" Flush Mounted Zinc Plated	\$89.95
3687 00551	Cam Rise, Chrome, Flush	79.95

Bolt-Action Walk-In Cooler Door Latch

- Cast iron body and strike, malleable iron handle and zinc-plated.

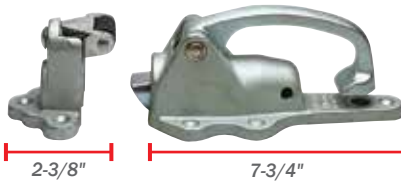

ITEM NO.	PRODUCT	EACH
3687 0056	Latch and Strike, 3/4" - 1-3/8" Offset	\$306.46
3687 0042	ISR Handle, 6" Door	16.95
ITEM NO.	PRODUCT	EACH
3687 0057	Latch and Strike, 1/8" - 5/16" Offset	\$306.50
3687 0042	ISR Handle, 6" Door	16.95

Heavy-Duty Door Closer

- Malleable iron with steel rod and tube with adjustable spring.
- Use with doors greater than 200 pounds.
- Zinc plated.



ITEM NO.	PRODUCT	EACH
3687 2949	Heavy-Duty Door Closer	\$565.68

SureClose™ Hydraulic Door Closer

Gas-loaded hydraulic cylinder guarantees controlled closure.

- Patented solid steel enclosed housing assures long wear.
- Extra-wide, bend-resistant hook ensures roller pick-up and overcomes alignment problems.
- Reliable operation even after half-million closures.
- Hook sold separately (order below).

NOTE: Hook sold separately. ORDER BELOW.

ITEM NO.	PRODUCT	EACH
3687 0005	Closer w/o Hook	\$148.36
3687 1002	Offset Hook	21.68
3687 1003	Flush Hook	16.60



Cold Storage Door Latch

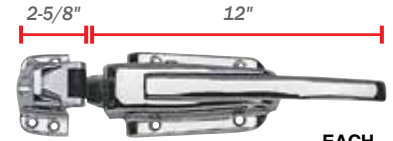

ITEM NO.	PRODUCT	EACH
3687 0047	Latch Body, Chrome	\$199.95
3687 0035	Strike, From Flush -1/8" to 1/4" Offset, Chrome	71.95
3687 0042	ISR Handle, 6" Door	16.95
ITEM NO.	PRODUCT	EACH
3687 0047	Latch Body, Chrome	\$199.95
3687 0038	Strike, 3/4" - 1-1/2" Offset, Chrome	71.95
3687 0042	ISR Handle, 6" Door	16.95
ITEM NO.	PRODUCT	EACH
3687 0046	Latch Body, Stainless	\$239.95
3687 0045	Strike, From Flush -1/8" to 1/4" Offset, Stainless	81.95
3687 24001	IRS Handle, 6" Door, Stainless	48.27
ITEM NO.	PRODUCT	EACH
3687 0046	Latch Body, Stainless	\$239.95
3687 0037	Strike, 3/4" - 1-5/8" Offset, Stainless	79.95
3687 24001	IRS Handle, 6" Door, Stainless	48.27

Heavy-Duty Cold Storage Door Latch



- Die-cast zinc body and strike housing.

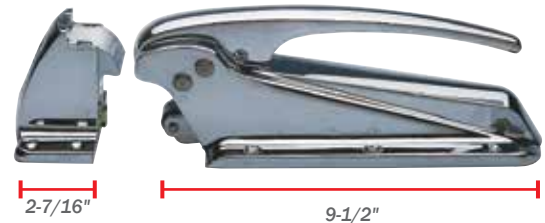

ITEM NO.	PRODUCT	EACH
3687 0041	Latch and Strike, 1-1/8" - 1-5/8" Offset	\$299.95
3687 0039	Inside Lever Assembly	39.95

Heavy-Duty Reversible Cam-Rise Door Hinge



- Choose zinc-plated or stainless steel.



ITEM NO.	PRODUCT	EACH
3687 00501	23" Flush Mounted Zinc Plated	\$89.95
3687 00511	23-1/8" Zinc Plated, 1-1/4" Offset	89.95
3687 00531	23-1/8" Zinc Plated, 1-1/2" Offset	99.95
3687 00541	13-11/16" Stainless, 1-1/4" Offset	299.95

Shat-R-Shield® Incoplas™ LED Hybrid

Functional as an area light, flood light or wall pack.
Tailored to your custom specification.

- Available in three mounting options, adjustable, surface or wall.
- One person installation with built-in self-leveling kit.
- Choose from 45 or 90 Watts.
- Lumen Output: Up to 5,000 (45 W); Up to 10,000 (90 W).
- Voltage: 120-277 V.
- Operating Temperature: -22 °F to 113 °F (-30°C to 45°C).
- Up to 122 °F (50 °C) in 5,000 lumen package.
- Dimming: 0-10 V.
- Weight: 7-1/2 pounds.
- Dimensions: 13 inches L x 10-1/4 inches W x 5-3/5 inches H.

shat-r-shield lighting inc.



SPECIAL ORDER ITEM

At 7-1/2 pounds, this fixture is extremely light-weight.



Thumb screw makes junction box easily accessible and can be loosened or tightened without using any tools; allows for a simple one-person installation.

Stainless steel screws are corrosion-resistant and can withstand the harshest environments.

Tapered fins allow for water runoff so the fixture can be washed down with high-pressure as often as needed.

Frosted polycarbonate lens (shown) is 1 of 5 lens options. This particular lens is optically engineered to eliminate hotspots and create uniform, glare-free illumination.

Choose From 3 Mounting Options:



Adjustable Mount



Surface Mount



Wall Mount*

ITEM NO.	PRODUCT	EACH
3208 00091	45 Watt Fixture with Mount	\$509.75
3208 00101	90 Watt Fixture with Mount	631.55

*NSF rating does not apply to this mount.

Shatter-Coated Insect Bulbs

- 2x contact.



▶ SEE PAGES 580-581 For Insect Light Traps



ITEM NO.	PRODUCT	WATTAGE	F.O.B. FACTORY EACH
E756 00081	T8, 18"	15 Watt	\$13.95
E756 00281	T8, 24"	20 Watt	19.95
E756 00091	T12, 24"	20 Watt	17.95
E756 00311	EL-07T820S, 24"	20 Watt	19.95
E756 00031	T12, 48"	40 Watt	22.95
E756 00341	EL-09T840S, 48"	20 Watt	19.95

Shat-R-Shield® Waterproof LED Lamps

IP68 Waterproof, Safety-Coated LED lamps have a thin layer of silicone coating that completely seals the lamp to protect fragile electronic components against moisture, corrosion and premature failure. Ideal for any application exposed to harsh environments.

- Shatter-resistant, safety-coated lamps will contain all particles if the lamp is accidentally broken.
- The coating does not affect light output. <1% lumen loss.



shat-r-shield lighting inc.

ITEM NO.	PRODUCT	EACH
3208 00051	A. 75 Watt Equivalent	\$30.75

▶ 10 PER CASE.

ITEM NO.	PRODUCT	EACH
3208 00041	B. 65 Watt Equivalent	\$28.05

▶ 12 PER CASE.

FLB Standard Service Light Fixtures

- Rugged UV stabilized non-metallic housing and one piece molded, impact resistant acrylic lens.
- Universal voltage electronic ballast. Energy saving lamp and ballast configuration.
- State-of-the-Art universal voltage electronic ballast. • High-pressure tested to 1500 psi.
- 12 stainless steel captive latches for positive lens fit against a poured-in-place closed cell polyurethane gasket.
- NSF Certified for splash zone, NEMA 4x certified and IP 67 certified.
- Completely assembled — ready to install out-of-the-box.
- Toolless entry for easy installation and maintenance.

SPECIAL ORDER ITEM



Stainless steel hook mount.



Stainless steel mounting bracket.

▶ SEE PAGE 554 For Bulbs, Sold Separately

ITEM NO.	PRODUCT	BULB TYPE	WATTAGE	F.O.B. FACTORY EACH
3436 0434	4' FLB	4-Lamp, T5	54 Watt	\$449.58
3436 0435	4' FLB	6-Lamp, T5	54 Watt	478.17

FLB-RS (Rough Service) Light Fixtures

- Rugged UV stabilized non-metallic housing and one-piece molded, impact resistant acrylic lens.
- Proven lampholder bridge system with plunger and stationary lampholder set.
- State-of-the-art universal voltage electronic ballast.
- Toolless entry for easy installation and maintenance.
- 12 stainless steel captive latches for positive lens fit against a poured-in-place closed cell polyurethane gasket.
- Reinforced stainless steel mounts for numerous mounting options.
- Completely assembled — ready to install out-of-the-box.
- High-pressure tested to 1500 psi. • 6-foot factory installed lead. • Instant restrike.
- NSF Certified for splash zone, NEMA 4x certified and IP 67 certified.



Lampholder bridge.



Stainless steel chain mount bracket.

▶ SEE PAGE 554 For Bulbs, Sold Separately

ITEM NO.	PRODUCT	BULB TYPE	WATTAGE	F.O.B. FACTORY EACH
3436 0438	4' FLB-RS.	4-Lamp, T5	54 Watt	\$515.33
3436 0439	4' FLB-RS.	6-Lamp, T5	54 Watt	668.19



Vapor Guard Wet Light Fixtures

- One-piece closed cell polyurethane gasket is molded into the edge of the housing.
- Fiberglass housing allows light to be mounted in corrosive and wet locations.
- Conduit entries have a sealed plastic closure plug. • For use in environments down to -20 °F.
- Toolless entry for easy bulb replacement. • Unit comes with plastic latches.
- UV stabilized lens. • NSF certified and ETL listed.



Optional Stainless Steel Latches and Standard Mounting Bracket.



▶ SEE PAGE 554 For Bulbs, Sold Separately

ITEM NO.	PRODUCT	F.O.B. FACTORY EACH
3436 2545	4', 2-Lamp, 54 Watt, High Output	\$334.77
3436 8634	4', 3-Lamp, 54 Watt, High Output	262.48
3436 8635	8', 4-Lamp, 54 Watt, High Output	478.73
3436 8636	8', 6-Lamp, 54 Watt, High Output	536.26

NOTE: NSF and UL listed.

Vapor Guard Replacement Parts	ITEM NO.	PRODUCT	EACH
	3436 20041	4' Replacement Cover, Ribbed Lens	\$35.72
	3436 10081	8' Replacement Cover, Ribbed Lens	62.35
	3436 22011	Replacement S.S. Mounting Brackets.	15.83
For use with Vapor Guard fixtures only.	3436 10041	Optional S.S. Latch Kit for 4' Fixture	45.07
Will NOT work with other brands.	3436 10071	Optional S.S. Latch Kit for 8' Fixture	72.62
	3436 04601	4' Clear Lens	42.88
	3436 04611	8' Clear Lens	62.35





Sealed design for high-pressure washdown areas.



Recessed O-ring for water tight seal.



Waterproof power pig tail. (Shown with optional watertight mini-connector.)

Seal Lite High-Pressure Washdown Lighting Fixtures

Totally sealed design for high-pressure washdown areas.

- All exposed areas are made from non-corrosive materials.
- Chemical- and crack-resistant acrylic lens.
- Universal voltage.
- UL listed.
- Aluminum interior materials for safety and long life.
- 6-foot pigtail cable is included as well as two 1-foot stainless steel hanging chains.



Standard unit with white end caps. Unit shown with T5 bulbs.

Optional stainless steel end caps. Unit shown with T8 bulbs.

Optional Emergency Battery Backup Light available. Call for more details.

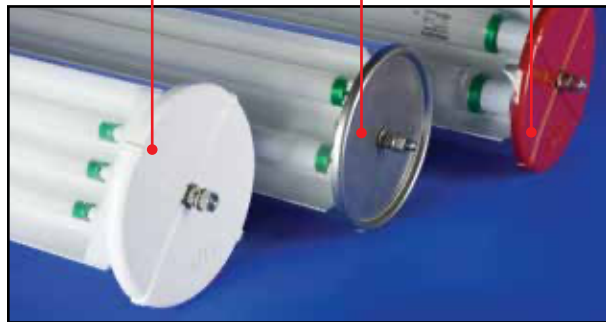

T5 High Output

Mini Bi-pin, Universal Voltage

ITEM NO.	LENGTH	BULBS REQUIRED	WATTAGE	EACH
3436 4254	4'	2x, T5 - 48" Bulbs	.54 Watt	\$508.58
3436 4354	4'	3x, T5 - 48" Bulbs	.54 Watt	480.23
3436 8455	8'	4x, T5 - 48" Bulbs	.54 Watt	689.12
3436 8654	8'	6x, T5 - 48" Bulbs	.54	768.88

Replacement Parts

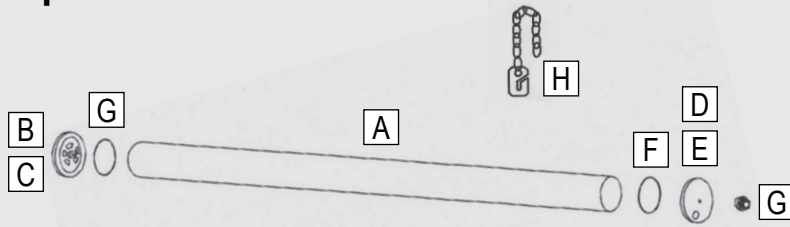

Call 800-456-5624 For Current Pricing

ITEM NO.	PRODUCT
3436 30081	A. Standard 8' Lens, Clear
3436 0010	B. End Cap, Plastic Non-Electrical
3436 0008	C. End Cap, Stainless Steel, Non-Electrical
3436 0011	D. End Cap, Plastic, Electrical
3436 0009	E. End Cap, Stainless Steel, Electrical
3436 00021	F. O-Ring Rubber Gasket Seal
3436 0005	G. Washer w/Gasket, Stainless Steel
3436 0013	H. Stainless Steel Chain, 1' Mounting Kit
3436 00021	F. O-Ring Rubber Gasket Seal
3436 0005	G. Washer w/Gasket, Stainless Steel
3436 0013	H. Stainless Steel Chain, 1' Mounting Kit

Poseidon Washdown LED Lighting

- Dust tight and waterproof rated.
- Polycarbonate, shatterproof lens.
- Up to 70% energy savings compared to standard fixtures.
- Ceiling mounted fixtures.



Call 800-456-5624 For More Information



A QSSI Company Since 1985



MOUNTING ACCESSORIES:
Both included with every unit.



Metal Bracket



Suspending Cable



ITEM NO.	PRODUCT	AMBIENT TEMP RANGE	WATTAGE	EACH
J680 00241	Poseidon 48" Linear Light	-4° to 149°-40° to 122 °F	80 Watt	\$620.05



70% Energy Savings



2 Year ROI



Shatterproof



Waterproof

LED WDL, Washdown Light

- WDL is an energy efficient linear LED fixture designed specifically for heavy wash-down applications.
- IP69K rated enclosure utilizes a 0.125-inch thick chemical and impact resistant frosted lens which provides a glare-free wide distribution light pattern similar to fluorescent products.
- UL 1598 for wet locations and battery back-up.
- ANSI/NSF 2 certified for splash zones.
- CSA Std C22.2 No.250.0



ITEM NO.	PRODUCT	SIZE	F.O.B. FACTORY	
			EACH	
3436 2122	LED WDL	4 ft.	\$707.87	
3436 2123	LED WDL	8 ft.	1,171.37	

LED PIPE LITE Series

- PIPE LITE provides a cost effective, precise, uniform, glare-free, LED task lighting solution for the food processing industry.
- IP69K rated housing allows for easy clean-up while withstanding the rigors of daily sanitation.
- UL 1598 for wet locations and battery back-up.
- Tube-less design reduces costs by eliminating replacement tubes.
- ANSI/NSF 2 certified for splash zones.
- CSA Std C22.2 No.250.0



ITEM NO.	PRODUCT	SIZE	F.O.B. FACTORY	
			EACH	
3436 01701	LED Pipe Task Light	2 ft.	\$543.73	
3436 42001	LED Pipe Task Light	4 ft.	652.70	
3436 82501	LED Pipe Task Light	8 ft.	1,026.97	

LED NML-RS

- Non-Metallic LED Rough Service is a low-bay solution to reduce energy usage without sacrificing lumen output.
- Frosted lens to provide a glare-free work environment.
- Completely assembled and ready to install.
- UL 1598 for wet locations.
- IP65, IP66, IP67 rated.
- Gray with clear lens.



ITEM NO.	PRODUCT	F.O.B. FACTORY	
		EACH	
3436 0015	LED NML-RS	\$1,314.40	

LED Light Fixture



- Low profile high-impact Lexan anti-glare globe.
- Designed for damp/wet/cooler/freezer environments.
- Operational for -40 °F (-40 °C) to 104 °F (40 °C).
- Designed to reduce electrical usage by 85%.
- Minimal heat generation.
- Surface mount design.
- LM-79 tested.



ITEM NO.	PRODUCT	DIMENSIONS	F.O.B. FACTORY	
			EACH	
3687 80801	1808 LED Fixture	5-1/2" x 3-1/5"	\$189.36	

LED Emergency Exit Signs For Wet Locations

- 90 minute emergency exit lighting. • Long life nickel cadmium batteries. • Test switch and test light.
- Exit signs have extended life LED lamps. • State-of-the-art water tight ventilation system for wet locations.
- Non-corrosive enclosures and external hardware. • Completely assembled — ready to install out-of-the-box.
- Exit sign illuminates continuously in AC and power failure modes (egress model downlight illuminates in power failure mode).
- Meets or surpasses safety codes for emergency lighting.



F.O.B. FACTORY



Emergency Exit Light

with Egress Downlight

ITEM NO.	PRODUCT	EACH
3436 04401	120V	\$578.35
3436 04411	277V	578.35

Emergency Exit Light

No Downlight

ITEM NO.	PRODUCT	EACH
3436 04421	120V	\$473.19
3436 04431	277V	473.19

Shown with
egress downlight.

AC Only Powered Exit Signs

- Energy efficient LED lamps.
- Non-corrosive enclosures and external hardware.
- Meets or surpasses safety codes for emergency lighting.
- Completely assembled — ready to install out-of-the-box.



ITEM NO.	PRODUCT	EACH
3436 04441	120V	\$523.61
3436 04451	277V	523.61

EWP-LED Emergency Hose-Down Wall Pack Light Fixture

Compact emergency fixture specifically engineered for applications requiring protection in severe corrosion, heavy hose-down and wet environments.

- Two mounting options: Surface mount or aluminum angle mount.
- Long-life PL lamp with maximum illumination reflector.
- Stainless steel hardware on exposed areas.
- Sealed maintenance free battery.
- NEMA 4x polycarbonate enclosure.
- 3-foot cord conduit lead.
- Push button test switch.
- UL listed 924 Emergency.



F.O.B. FACTORY

ITEM NO.	PRODUCT	EACH
3436 1012	120V Surface Mount Fixture	\$546.81
3436 1013	277V Surface Mount Fixture	525.77
3436 12121	Aluminum Angle Bracket Mount	39.95

Keelgrid Suspended Ceiling System

- Fiberglass reinforced plastic grid doesn't conduct heat like metal grids. • FRP Rating: Class A.
- Unaffected by moisture and humidity. • Rust and corrosion proof. • Light-weight yet rigid.

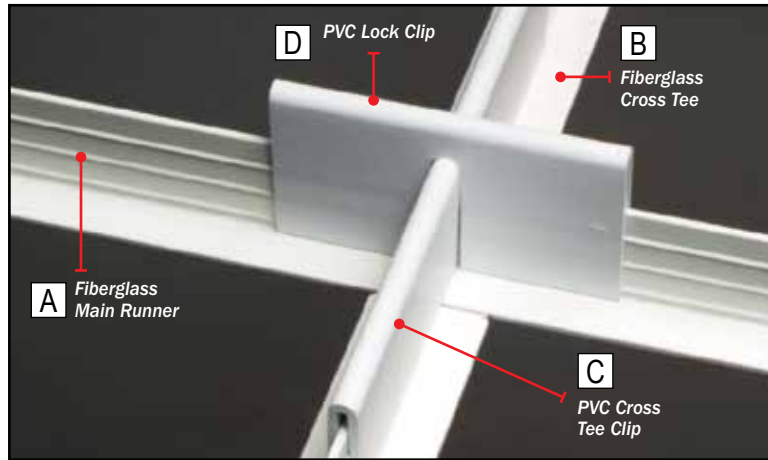

ITEM NO.	PRODUCT	F.O.B. FACTORY EACH
3110 80351	A. 12' Fiberglass Main Runner	\$57.65
3110 0478	B. 2' Fiberglass Cross Tee	11.15
3110 8036	4' Fiberglass Cross Tee	21.15
3110 8038	C. 8" PVC Cross Tee Clip	4.55
3110 8039	D. 4" PVC Lock Clip	2.95
3110 8037	6" PVC Splice Clip	2.75
3110 8040	Hold Down Clip for 0.090" & 0.004" Panels	0.76
3110 0479	Hold Down Clip for 1" Foam Panel	1.35
3110 8041	8' x 1.5" x 1.4" Fiberglass Angle	36.95
3110 8043	12' x 12-Gauge Galvanized Wire	2.95
3110 7220	12' x 12-Gauge Stainless Wire	12.95
3110 8044	0.12" x 1.5" Aluminum Pop Rivets (500)	70.95
3110 5273	Wall Clips	4.15

EASY TO INSTALL



1. Easy to install with positive "cross tee" grid lock brackets.



2. No special tools required. Use simple hand tools.



3. Ceiling panels resist moisture, match wall coverings and are easily removed for repair of service utilities.

Suspended Ceiling Panels

FRP Panels (Fiberglass Reinforced Plastic)



A. 0.09-inch FiberLite Liner Ceiling, 2-foot x 4-foot Textured FRP panel with no substrate backer.



B. 1-inch EPS Foam is laminated to 1/2-inch fire and moisture-resistant gypsum and FiberLite FRP one side only. 2 feet x 4 feet.



C. 1-1/2-inch EPS Foam is laminated to 1/2-inch fire and moisture-resistant gypsum and FiberLite FRP one side only. 2 feet x 4 feet.



D. 2-inch EPS Foam is laminated to 1/2-inch fire and moisture-resistant gypsum and FiberLite FRP one side only. 2 feet x 4 feet.

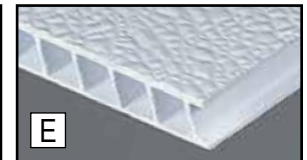

E. 0.4-inch FiberCorr Liner Ceiling, 2-foot x 4-foot textured FRP panel with no substrate backer.

► PURCHASE IN MULTIPLES OF 4.

ITEM NO.	PRODUCT	F.O.B. FACTORY EACH
3149 0912	A. FiberLite Liner Ceiling Panel 0.090", 2' x 4' Texture FRP Panel - No Substrate Backer	\$24.30
3149 5100	B. FiberLite Insulated Ceiling Panel, 1" EPS Foam, 2' x 4' FRP	CALL FOR PRICING
3149 0151	C. FiberLite Insulated Ceiling Panel, 1-1/2" EPS Foam, 2' x 4' FRP	CALL FOR PRICING
3149 5200	D. FiberLite Insulated Ceiling Panel, 2" EPS Foam, 2' x 4' FRP	CALL FOR PRICING
3149 4004	E. FiberCorr Ceiling Panel 0.400", 2' x 4' FRP Panel	CALL FOR PRICING

Stainless Steel Hanger for Ceiling Grid System

Perfect for suspension lighting systems.

- Supports 25 pounds.

ITEM NO.	PRODUCT	EACH
3110 0001	25 lb Hanger	\$14.95



Established 1992

Extrutech Plastics, Inc.
ISO 9001-2008 Certified

Extrutech PVC Panels

• 2 foot x 4 foot x 3/8 inch.

► PURCHASE IN MULTIPLES OF 4.

ITEM NO.	PRODUCT	F.O.B. FACTORY EACH
E090 40041	PVC Ceiling Panel	\$34.95

Extrutech Tongue and Groove 1/2-Inch PVC Ceiling and Wall Covering

Stain-resistant, low-maintenance, waterproof panels are also easy to clean and ideal for high moisture areas. Materials are totally recyclable. Never needs painting and will not rot or rust.

- Panels meet ASTM E-84-05 and CAN/ULC S102.2-3 Class A fire rating.
- Custom cut lengths up to 20 feet long.
- No exposed fasteners.
- Can easily be cut using fine tooth blade, table saw or utility knife.
- Panels are 100% recyclable and do not support mold or mildew per ASTM D3273 and D3274.
- Panels are extruded from exterior-grade PVC.
- Easy to install using the tongue and groove system.
- Cleans with pressure washers or soap and water.
- Can be attached directly to walls and ceilings.
- Limited 10 year warranty.

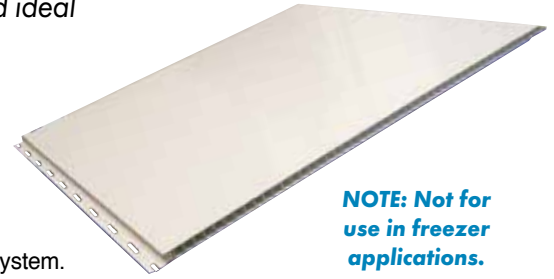

NOTE: Not for use in freezer applications.

F.O.B. FACTORY

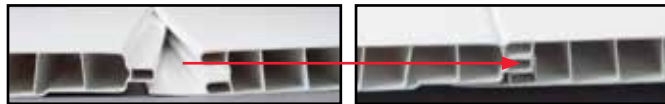

Panels slide together with tongue and groove design leaving no exposed fasteners to rust or promote mold or bacteria growth. Use stainless steel screws to connect nailing fin to wall or stud.

Call 800-456-5624 for Custom Room and Ceiling quotes.

FINISHING TRIP OPTIONS:

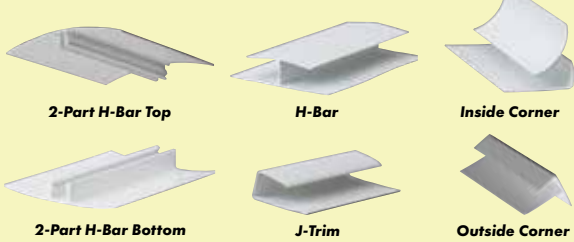

ORDER PVC CEILING AND WALL COVERING

Please have the following information available.

SPECIAL ORDER ITEM

Covering: Full Room (walls and ceiling) Walls Only Ceiling Only

Room dimensions: Length _____ Width _____ Height _____

Panel directions (ceilings only): Perpendicular to trusses Parallel to trusses

Rubberized Silicone Sealant

- Meets FDA and USDA requirements for use in federally inspected meat and poultry plants.
- Will not crack, crumble or dry out.
- Temperature range: -60 °F to +450 °F.

MADE IN USA



▶ 12 PER CASE.

ITEM NO.	PRODUCT	EACH
3149 12881	White, 11 oz.	\$11.05
3149 12891	Clear, 11 oz.	13.95

Multi-Purpose Adhesives

- Specially formulated for bonding fiberglass reinforced plastic to various substrates.
- Fast setting and resistant to temperature changes.

MADE IN USA



ITEM NO.	PRODUCT	EACH
3149 1359	11-oz. Tube	\$7.25
3149 0006	4-Gallon Pail, Latex-Based	110.25



Stainless Steel Corners

F.O.B. FACTORY

Protect interior corners from damage.

- Custom widths and lengths available.
- Six pre-drilled holes.

ITEM NO.	PRODUCT	DIMENSIONS	EACH
2510 22361	Outside	2" x 2" x 36"	\$63.95
2510 22481	Outside	2" x 2" x 48"	68.05
2510 22601	Outside	2" x 2" x 60"	78.95
2510 22721	Outside	2" x 2" x 72"	85.35
2510 22371	Inside	2" x 2" x 36"	63.95
2510 22491	Inside	2" x 2" x 48"	68.05
2510 22611	Inside	2" x 2" x 60"	78.95
2510 22731	Inside	2" x 2" x 72"	123.15

Fiberglass Wall Coverings

- Meets USDA requirements.
- Meets Class C/3 Fire Rating per ASTM E 84.

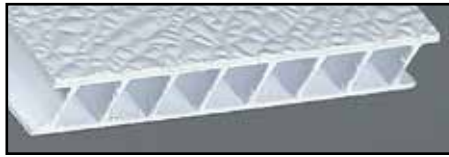

0.09-Inch Textured Wall Liner Panels

Orders Under 20 Panels Require a Crate Fee

0.4-Inch FiberCorr Wall Panel

Orders Under 12 Panels Require a Crate Fee

0.375-Inch Laminated Wall Panel

Orders Under 16 Panels Require a Crate Fee

ITEM NO.	PRODUCT	F.O.B. FACTORY EACH
3149 1313	4' x 8' x 0.090"	CALL
3149 1314	4' x 10' x 0.090"	FOR
3149 4451	4' x 12' x 0.090"	PRICING
3149 1429	4' x 50' x 0.090"	

ITEM NO.	PRODUCT	F.O.B. FACTORY EACH
3149 4463	4' x 8'	CALL
3149 4464	4' x 10'	FOR
3149 4012	4' x 12'	PRICING

ITEM NO.	PRODUCT	F.O.B. FACTORY EACH
3149 4469	4' x 8'	CALL
3149 4470	4' x 10'	FOR
3149 7512	4' x 12'	PRICING

White Nylon Rivets

Non-corroding, white nylon rivets fasten panels to wood, metal, drywall and concrete.

- Rivets will expand into either solid substrates behind sheet material or metal studs.

NOTE: Recommended 1 per square foot.



▶ 100 PER BAG.

ITEM NO.	SIZE	BAG
3149 12801	3/4"	\$19.51
3149 12811	1"	20.75
3149 12821	1-1/2"	46.35
3149 1283	2"	70.15

Stainless Steel Fastener

- One-step fastening for FRP panels eliminates pre-drilling and provides an expansion relief allowing thermal expansion of paneling products after fastening.
- Rustproof, reusable fasteners use Phillips or square drive bits.

NOTE: Recommended 1 per square foot.



▶ 100 PER BAG.

ITEM NO.	SIZE	BAG
3149 12001	1-1/4" Stainless Fastener	\$64.95

Vinyl Moldings For Wall Panel Installation



0.09-Inch Panels Molding

ITEM NO.	PRODUCT	F.O.B. FACTORY EACH
3149 1290	8' Cap	\$4.56
3149 1291	10' Cap	5.99
3149 0038	12' Cap	5.95
3149 1292	8' Division Bar	4.53
3149 1293	10' Division Bar	6.00
3149 3106	12' Division Bar	7.60
3149 1294	8' Inside Corner and Cove	4.55
3149 1295	10' Inside Corner and Cove	5.98
3149 0552	12' Inside Corner & Cove	7.56
3149 1296	8' Outside Corner and Cove	3.49
3149 1297	10' Outside Corner and Cove	6.00
3149 0099	12' Outside Corner & Cove	7.53
3149 1459	8' Inside Corner Angle	12.20
3149 1460	10' Inside Corner Angle	13.59
3149 0014	12' Inside Corner Angle	13.59
3149 1308	8' Outside Corner Angle	12.14
3149 1309	10' Outside Corner Angle	13.59
3149 9001	12' Outside Corner Angle	13.59
3149 1279	8' Base Cove 3"	15.26
3149 1277	10' Base Cove 3"	25.86
3149 1306	12' Base Cove 3"	25.86

0.4-Inch FiberCorr Panel Molding

ITEM NO.	PRODUCT	F.O.B. FACTORY EACH
3149 0042	8' Cap	\$7.60
3149 0029	10' Cap	9.13
3149 9000	12' Cap	9.12
3149 1108	8' Division Bar	9.95
3149 1104	10' Division Bar	13.68
3149 0063	12' Division Bar	12.06
3149 1302	8' Inside Corner and Cove	9.13
3149 1303	10' Inside Corner and Cove	10.60
3149 0122	12' Inside Corner and Cove	13.61
3149 1304	8' Outside Corner and Cove	9.13
3149 1305	10' Outside Corner and Cove	27.82
3149 0124	12' Outside Corner and Cove	13.63
3149 0016	8' Inside Corner Angle	19.80
3149 0017	10' Inside Corner Angle	24.40
3149 0024	12' Inside Corner Angle	28.73
3149 0018	8' Outside Corner Angle	19.80
3149 0019	10' Outside Corner Angle	22.81
3149 0028	12' Outside Corner Angle	27.39
3149 1279	8' Base Cove 3"	15.26
3149 1277	10' Base Cove 3"	25.86
3149 1306	12' Base Cove 3"	25.86

0.375-Inch Panel Molding

ITEM NO.	PRODUCT	F.O.B. FACTORY EACH
3149 1298	8' Cap	\$7.54
3149 1299	10' Cap	7.53
3149 1020	12' Cap	9.09
3149 1300	8' Division Bar	9.09
3149 1301	10' Division Bar	10.60
3149 0098	12' Division Bar	13.64
3149 1302	8' Inside Corner and Cove	9.13
3149 1303	10' Inside Corner and Cove	10.60
3149 0122	12' Inside Corner and Cove	13.61
3149 1304	8' Outside Corner and Cove	9.13
3149 1305	10' Outside Corner and Cove	27.82
3149 0124	12' Outside Corner and Cove	13.63
3149 0016	8' Inside Corner Angle	19.80
3149 0017	10' Inside Corner Angle	24.40
3149 0024	12' Inside Corner Angle	28.73
3149 0018	8' Outside Corner Angle	19.80
3149 0019	10' Outside Corner Angle	22.81
3149 0028	12' Outside Corner Angle	27.39
3149 1279	8' Base Cove 3"	15.26
3149 1277	10' Base Cove 3"	25.86
3149 1306	12' Base Cove 3"	25.86

Dura-Seal 400 Light-Duty Industrial Concrete Floor Coatings

Chemically resistant and good in a water environment. Odorless after curing.

- One, 2-gallon container applies two coats over 325 sq. ft.
- By mixing 50/50, coating penetrates pores and forms a solid surface plate recognized by the USDA as a contaminant barrier.
- Apply by roller, brush or spray — leaves an easy-to-clean, hard, glossy surface suitable for incidental food contact.
- Meets all USDA and EPA standards.
- Quick-drying coating hardens to a 6-8 mil thickness.

NOTE: Must purchase floor prep/cleaning products shown below to validate manufacturer warranty.



F.O.B. FACTORY

ITEM NO.	PRODUCT	EACH
SEE RIGHT	Dura-Seal 400*	\$284.85
A468 1000	Satin Skid-Resistant Texture	19.75

*2 Gallons (Specify color and surface)

DURA-SEAL 400 COLORS

ALUMINUM	FAUN	BROWN	BLUE GREEN
CLEAR	OSHA YELLOW	TILE RED	DARK GREEN
WHITE	CREAM	DEEP RED	CHARCOAL
FLAT GRAY	BUFF	LIGHT BLUE	COCO BROWN
HOUSE GRAY	TERRA-COTTA	TURQUOISE	MEDIUM GREEN
LIGHT GRAY	TAN	BLUE	LIGHT GREEN
GRAY	TAUPE		



Both Dura-Seal and Dura-Poxy coatings produce a high polish surface finish.



Optional Satin Texture Surface.

Degrease Rite Floor Prep/Cleaning

High-alkaline water-based industrial liquid cleaner, 11.5 pH. USDA approved. Cleans oils, grease, fats, wax, dirt and stains.

- 1 gallon covers up to 500 sq. ft.



F.O.B. FACTORY

ITEM NO.	PRODUCT	EACH
A468 1002	Degrease Rite, 1 Gallon	\$32.95

Dura-Kleen Floor Prep/Cleaning

Heavy-duty acid-based industrial liquid cleaner, 5 pH w/detergents and water softener. Cleans scale and mineral stains.

- 1 gallon covers up to 300 sq. ft.



F.O.B. FACTORY

ITEM NO.	PRODUCT	EACH
A468 1001	Dura-Kleen, 1 Gallon	\$35.15

Dura-Poxy Industrial Heavy-Duty Concrete Floor Coatings

A heavier-bodied "100% solids" catalyzed epoxy laminate. Very hard and highly chemically resistant. No odor. Hardens even in a water environment. Accepted by the USDA for Incidental food contact use. For use on floors with major irregularities.

- 8-hour curing time. • 1 gallon covers 125 square feet. at 8-10 mil.
- Quick drying coating hardens to a 20 mil thickness with 2 coats.
- For use on floors with major irregularities in the surface and floors that require maximum resistance to damage from falling tools, forklifts and similar causes of harm.
- Mix with quartz chips for high skid areas (such as wet or frosty environments) and to form a coating that is resistant to the passing of steel wheels or other heavy machinery.



Optional Quartz Granular Surface

NOTE: Require temperatures of at least 55 °F during application.

NOTE: Must purchase floor prep/cleaning products shown below to validate manufacturer warranty.

ITEM NO.	COLOR
A468 00371	000 Dura Poxy Clear
A468 00351	100 Dura Poxy White
A468 00381	110 Dura Poxy Light Gray
A468 00331	112 Dura Poxy Gray
A468 00341	118 Dura Poxy Faun
A468 00361	160 Dura Poxy OSHA Yellow
A468 00321	270 Dura Poxy Tile Red
A468 00311	900 Dura Poxy Black

DURA-POXY COLORS

CLEAR	GRAY	TILE RED
WHITE	FAUN	FLAT BLACK
LIGHT GRAY	OSHA YELLOW	

F.O.B. FACTORY

ITEM NO.	PRODUCT	EACH
SEE ABOVE	Dura-Poxy (above), 1 Gallon (Specify color and surface)	\$205.65
A468 0003	Quartz, 50 lb Bag	77.71

Plastic Lockers

Perfect for use in food processing plants or any wet environment.

- Maintenance-free washdown lockers are rust proof and non-corrosive.
- Engraveable aluminum ID plate on all lockers.
- Sanitary holes for easy drainage.
- One-piece, double-wall construction makes these lockers durable and easy to install.
- Available with sloped hoods for extra storage space.
- 36-inch lockers come with double-coat hook (1 each).
- 60-inch lockers come with double-coat hook (1 each) and shelf.



ITEM NO.	PRODUCT	BASE DIMENSIONS	SHIP WT.	F.O.B. FACTORY EACH
3177 7202	A. 18" w/Drain Holes	15" x 15"	10 lb.	\$168.65
3177 7203	B. 18" w/Drain Holes and Hood	15" x 15"	12 lb.	207.15
3177 7204	C. 36" w/Drain Holes	12" x 15"	19 lb.	230.00
3177 7205	D. 36" w/Drain Holes and Hood	15" x 15"	21 lb.	240.00
3177 7206	E. 60" w/Drain Holes and Hood	15" x 18"	42 lb.	424.95
3177 5109	Wall Mount Installation Kit			105.25

Bollard Covers

Constructed from 1/8-inch thick polyethylene and 3M™ reflective tape for durability and long service life.

- Patented GripperTabs™ for fast and easy installation — self-adhesive fingers stick to the bollard itself and the cover just slides over.
- UV rated against fading for 5 years. • Cover colors: yellow, red, gray, white, blue and black.
- Reflective tape colors: red, black, white, yellow, orange and blue. • Dome shape: flat or dome.

NOTE: Please specify cover and tape color, dome or flat top and length when ordering.

ITEM NO.	PRODUCT	MAX PIPE O.D.	EACH
B753 10041	4" Bollard Cover	.4-1/2"	CALL
B753 10071	6" Bollard Cover	.6-3/5"	FOR
B753 0006	8" Bollard Cover	.8-3/5"	PRICING

SPECIAL ORDER ITEM



MADE IN USA

SPECIAL ORDER ITEM

Indoor/Outdoor Stainless Steel Benches and Back Supports

- Formed 12-gauge legs are provided with mounting holes allowing unit to be bolted to floor.
- Constructed from heavy duty corrosion resistant T-304 stainless steel.
- Easy to assemble, no special tools required.
- Ships knocked down for additional freight savings.

KNOCKS DOWN FOR SHIPPING

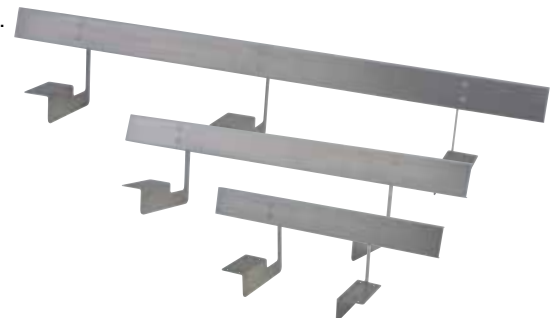

NOTE: Benches and backs are sold separately.

ITEM NO.	PRODUCT	DIMENSIONS	EACH
2990 0053	3 ft. Bench	.36" x 12" x 18"	\$1,373.25
2990 0054	4 ft. Bench	.48" x 12" x 18"	554.95
2990 0055	6 ft. Bench	.72" x 12" x 18"	620.40
2990 0056	8 ft. Bench	.96" x 12" x 18"	749.95
2990 0057	4 ft. Bench, ADA Compliant	.48" x 20" x 18"	969.50

ITEM NO.	PRODUCT	EACH
2990 0192	4 ft. Back Support	\$398.96
2990 0193	6 ft. Back Support	519.60
2990 0194	8 ft. Back Support	578.90

PLUS Cart Package with Tray

Allows for quick application of up to 75 feet of barrier system.

- Industrial strength metal cart with foam handle for comfort.
- Foot lock brake and industrial wheels for easy maneuverability.
- Velcro tie downs keep bases firmly in place.
- Rust-proof, suitable for indoor/outdoor use.
- Height adjustable telescoping stanchions have twist-off removable spike for dual-purpose use – in soft ground surfaces with spike or in base by removing spike.
- Low-profile base can be filled with up to 18 pounds of water or 25 pounds of sand.
- Features push pin lock for added security and ability to easily interchange belts.

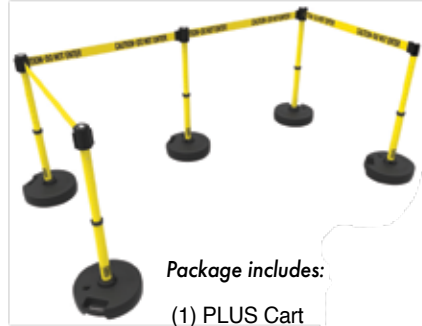

Package includes:

- (1) PLUS Cart
- (5) PLUS Stanchions
- (5) PLUS Bases
- (5) 15-Foot PLUS Banner Heads
- (1) Cart Accessory Tray



ITEM NO.	PRODUCT	MRF. NO.	LENGTH	PRINT	EACH
J869 00021	PLUS Cart Package, Yellow . . .	PL4078T	75 ft.	"Caution - Do Not Enter"	CALL FOR PRICING

PLUS Wall Mount Barrier System

Specially designed to be surface mounted when floor space is limited.

- Can be attached permanently to any wall surface using wood screws, wall anchors or zip ties (included)
- Ideal for blocking hallways, aisles, restrooms, corridors, and more. • Holds 15 feet of retractable belt banner made of 2-1/2-inch wide polyester fabric.
- Features push pin lock for added security and ability to easily interchange belts. • Rust-proof, suitable for indoor/outdoor use.

Package includes:

- (1) PLUS Wall Mount Kit
- (1) 15-Foot PLUS Banner Head



ITEM NO.	PRODUCT	MRF. NO.	LENGTH	PRINT	EACH
J869 00051	PLUS Wall Mount System, Yellow	PL4108	15 ft.	"Caution - Do Not Enter"	CALL FOR PRICING

Magnetic Wall Mount Barrier System

Specially designed for a quick surface mount.

- Secures to most surfaces with powerful magnet or integrated suction cup attaching to magnetic and non-magnetic surfaces including metal, stainless steel, glass, wood and plastic.
- Retractable belt is made of 2-1/2 inch wide polyester fabric. • Rust-proof, suitable for indoor/outdoor use.

Package includes:

- (2) Suction Cups
- (1) Retractable Belt



ITEM NO.	PRODUCT	MRF. NO.	LENGTH	PRINT	EACH
J869 00031	A. Magnetic Wall Mount, Yellow	MH7006	7 ft.	"Closed for Maintenance"	CALL FOR PRICING
J869 00041	B. Magnetic Wall Mount, Red	MH5009	30 ft.	"Danger - Keep Out"	CALL FOR PRICING

PLANT MAINTENANCE

FIND IT FAST

Flashlights	564-565
Batteries	566
Utility Brushes and Scrubbing Wipes	567
Spray Bottles and Caddy	567
Tapes and Coatings	568
Ladders	570
Mobile Work Centers	571
Blowers and Fans	572-573
Lubricants and Oils	574-576
Drum Pumps and Faucets	577
Absorbents and Soaker Pads	578-579
Filters	580
Sprayers	581
Insect Control	582-583
Door Gaskets, Sealants and Adhesives	584
Concrete Floor Patch Kit	584
Floor Grating and Stands	585



Multi-Use LED Water-Resistant Headlight

- Multi-use: headlight, magnet, hat clip, helmet.
- Includes 2 headstraps for wearing on head and rubber grip for helmet use.
- Adjustable spot to flood beam.
- High performance LED.
- Uses 3 AAA batteries, (included).



Includes rubber grip headstrap for attaching easily over hard hat.

80
LUMENS

ITEM NO.	PRODUCT	LUMENS	EACH
7784 20031	Multi-Use LED Headlight	80	\$21.95

RoughNeck LED Flashlight

Aluminum body withstands 7 foot drop test and is IPX4 water resistant.

- Compact design with 3 modes: low, high and strobe.
- Holster included.
- Beam distance up to 110 meters (360 feet).
- Uses 3 AAA batteries, (included).



UP TO
260
LUMENS

ITEM NO.	PRODUCT	LUMENS	EACH
7784 10231	RoughNeck LED	105-260	\$18.94

Sportsman Essentials® 3C LED Glow Ring Flashlight

Features a glow in the dark locator ring, which charges when the flashlight is in use and is IPX4 Water resistant.

- 2 modes: high: 310 lumens; energy saver: 95 lumens
- Beam distance: high: 141 meters; energy saver: 98 meters.
- 7-foot drop test performance (2 meters).
- Aluminum housing with non-slip grip.
- Uses 3 C batteries, (included).

UP TO
310
LUMENS



Glow in the dark locator ring

ITEM NO.	PRODUCT	EACH
7784 00961	Sportsman LED	\$29.95

Brite Essentials™ Laser Pointer Flashlight

- 9 LED flashlight with built-in laser pointer.
- Push button on/off.
- Aluminum construction with rubber grip.
- Uses 3 AAA batteries, (included).



22
LUMENS

Includes a laser pointer.

ITEM NO.	PRODUCT	EACH
7784 01061	Brite Essentials™	\$9.95

PolyStinger® LED Flashlight

- IPX4 water-resistant; 3 meter impact resistance tested.
- O-ring sealed, scratch-resistant polycarbonate lens.
- 3 Modes and Strobe: high: 485 lumens; 335 m beam, runs 3 hours; Medium: 240 lumens; 237 m beam, runs 5.5 hours; Low: 120 lumens; 167 m beam, runs 10 hours; Strobe: runs 7.5 hours.
- Super-tough, nylon polymer with rubberized comfort grip.
- Rechargeable NiMH battery.



ITEM NO.	PRODUCT	LENGTH	WEIGHT	EACH
3423 61611	LED PolyStinger®	8.07"	11.5 oz.	\$183.90



WARNING: The products on this page can expose you to chemicals including DEHP, which is known to the State of California to cause cancer and birth defects or other reproductive harm. For more information go to www.P65Warnings.ca.gov.

Virtually Indestructible LED Spotlight



- ANSI IP67 waterproof up to 1 meter, complete dust protection.
- 3 light modes: high, medium and low. • 15-foot drop test performance.
- High performance LEDs: high: 750 lumens; low: 80 lumens.
- Battery run time: high: 8 hours; low: 40 hours.
- Beam distance: high: 440 meters; low: 164 meters.
- Shatterproof lens and reflector. • Over-mold rubber head.
- Pistol grip compact design with handy wrist strap.
- Uses 6 AA batteries (included). 🔋

UP TO
750
LUMENS



ITEM NO.	PRODUCT	WEIGHT	LUMENS	EACH
7784 00731	LED 6AA Spotlight	4 lb.	80-750	\$54.08

Workhorse® Pro LED Virtually Indestructible Flashlight



- Aluminum-titanium body, rubber head and tail cap shock absorbers, shatterproof lens and reflector, impact resisting internal engineering.
- 2 modes: high: 350 lumens; energy saver: 70 lumens.
- Beam distance: 161 meters. • IP67 waterproof up to 1 meter.
- 30 foot drop tested. • Length: 9-1/2 inches.
- Uses 2 AA batteries, (included). 🔋

UP TO
350
LUMENS



ITEM NO.	PRODUCT	EACH
7784 01431	Workhorse® LED	\$20.66

6-Inch LED Penlight

- General purpose penlight clips conveniently in shirt pocket.
- Super bright white LED with beam distance up to 36 feet.
- Color will vary: blue, orange or silver. • Uses 1 AAA battery, (included). 🔋

3
LUMENS



NOTE: Color can NOT be specified.

ITEM NO.	PRODUCT	LENGTH	EACH
7784 01021	LED Penlight	6"	\$4.95

Virtually Indestructible LED Flashlight



Drop tested from 30 feet — the aluminum titanium body is so tough it will last a lifetime.

- Shatterproof lens and reflector with rubber shock absorbers to help protect impact-resistant internal parts.
- 2 modes: regular: 300 lumens; energy saver: 20 lumens
- Beam distance: regular: 168 meters; energy saver: 45 meters.
- Battery run time: regular: 3 hours; energy saver: 39 hours.
- ANSI IP67 waterproof up to 1 meter, complete dust protection.
- Uses 3 AAA batteries, (included). 🔋



UP TO
300
LUMENS

ITEM NO.	PRODUCT	LENGTH	EACH
7784 10031	Virtually Indestructible	5-3/8"	\$19.95

Dorcy LED Cyber Light



- True Spot Reflector technology provides 275-meter high beam distance for visibility.
- Heavy-duty lens, durable rubber and plastic housing withstand a 10-foot drop test.
- Rubber grip, push button switch and nylon lanyard.
- Uses 4 AA batteries, (included). 🔋

UP TO
190
LUMENS



ITEM NO.	PRODUCT	LENGTH	EACH
3353 47501	Dorcy LED Cyber	7-1/2"	\$29.95



WARNING: The products on this page can expose you to chemicals including DEHP, which is known to the State of California to cause cancer and birth defects or other reproductive harm. For more information go to www.P65Warnings.ca.gov.

Ultra PRO Alkaline Batteries

- Engineered for professional use.
- 10 year power guarantee (AAA/AA/C/D sizes only).



ITEM NO.	PRODUCT	QTY./PACK	PACK
7784 00045	AAA Size	8/Pack	\$3.95
7784 00035	AA Size	8/Pack	3.95
7784 00015	C Size	6/Pack	5.95
7784 00025	D Size	6/Pack	7.95

ITEM NO.	PRODUCT	QTY./PACK	PACK
7784 00075	9 Volt	6/Pack	\$10.95
A692 10131	LR44 1.5 Volt	2/Pack	6.54
7784 01095	LR44 1.5 Volt	6/Pack	10.80
3508 1131	LR1130 1.5 Volt	1/Pack	0.95

BATTERY REFERENCE CHART

Need a replacement battery for one of our products?
Use this chart to help identify the correct batteries needed.

FLASHLIGHTS				
ITEM NO.	PRODUCT	BATTERY	QTY. REQ.	BATTERY NO.
7784 01061	Brite Essentials Flashlight/Laser Pointer	AAA	3	7784 00045
3353 47501	Dorcy LED Cyber Light	AA	4	7784 00035
7784 01021	LED Penlight	AAA	1	7784 00045
7784 20031	Multi-Use LED Headlight	AAA	3	7784 00045
7784 10231	RoughNeck LED	AAA	3	7784 00045
7784 00961	Sportsman LED Glow Ring Flashlight	C	3	7784 00015
7784 10031	Virtually Indestructible LED Flashlight	AAA	3	7784 00045
7784 00731	Virtually Indestructible LED Spotlight	AA	6	7784 00035
7784 01431	Workhorse Pro LED Flashlight	AA	2	7784 00035
THERMOMETERS				
3098 51321	Atkins 351 Digital	AAA	2	7784 00045
3098 32301	Atkins EconoTemp w/HD Probe	AAA	3	7784 00045
3098 00311	Atkins EconoTemp w/HD Probe/Case	AAA	3	7784 00045
E542 59091	Big Red T-Handle Thermometer	LR44	1	7784 01095
A692 00181	C48 Thermocouple	AA	2	7784 00035
3368 0377	Compact Chart Recorder	AA	1	7784 00035
3542 41211	Digital Thermometer	1.5 V	1	7784 01095
3443 1051	Heavy-Duty Digital Thermometer	1.5 V	4	A692 10131
A692 00011	Infrared Non-Contact Thermometer	9 V	1	7784 00075
3098 22091	Infrared Thermometer	AAA	2	7784 00045
4599 10401	Lollipop Thermometers	LR44	1	7784 01095
4599 10501				
4599 00071				
3098 0450	Pocket Thermometer	1.5 V	1	7784 01095
3368 00041	Temperature Chart Recorder	AA	1	7784 00035
3368 10081	Temperature Chart Recorder	AA	4	7784 00035
3542 98671	Thermocouple Therm, Folding Probe	AAA	2	7784 00045
4599 00081	ThermoTrace Infrared/Probe	AAA	2	7784 00045
3611 00441	Waterproof Digital Probe	1.5 V	1	7784 01095
METERS				
3024 0015	pH Meter	9 V	1	7784 00075

SCALES				
ITEM NO.	PRODUCT	BATTERY	QTY. REQ.	BATTERY NO.
3416 20121	Checkweigh Scale	D	6	7784 00025
3416 00261	Low Profile Bench Scale	C	4	7784 00015
3416 00271	Low Profile Bench Scale	C	4	7784 00015
3416 00281	Low Profile Bench Scale	C	4	7784 00015
3416 3000	SS Washdown Safe Scale	AA	6	7784 00035
3416 0011	SS Washdown Scale	D	6	7784 00025
3416 0021	SS Washdown Scale	D	6	7784 00025
3416 1001	SS Washdown Scale	D	6	7784 00025
3416 2002	SS Washdown Scale	D	6	7784 00025
3416 5002	SS Washdown Scale	D	6	7784 00025
3416 00151	Washdown Compact Scale	D	6	7784 00025
3416 00161	Washdown Compact Scale	D	6	7784 00025
3416 00171	Washdown Compact Scale	D	6	7784 00025
3416 00181	Washdown Compact Scale	D	6	7784 00025
3416 0036	Bluetooth Washdown Compact Scale	D	6	7784 00025
3416 0035	Bluetooth Washdown Compact Scale	D	6	7784 00025
3416 0032	Bluetooth Washdown Compact Scale	D	6	7784 00025
3416 0037	Bluetooth Washdown Compact Scale	D	6	7784 00025
4893 00111	Washdown Portion Control Scales	D	4	7784 00025
4893 00211	Washdown Portion Control Scales	D	4	7784 00025
4893 00441	Washdown Portion Control Scales	D	4	7784 00025
4893 03211	Washdown Portion Control Scales	D	4	7784 00025
4893 30111	Washdown Portion Control Scales	D	4	7784 00025
4893 00391	Washdown Scale	D	6	7784 00025
4893 00401	Washdown Scale	D	6	7784 00025
4893 00411	Washdown Scale	D	6	7784 00025
4893 65551	Washdown Scale	D	6	7784 00025
TIMERS AND STOPWATCHES				
A692 02641	Countdown Timer	AAA	1	7784 00045
3098 04081	Multi-Station Timer	C	4	7784 00015
3098 00151	TFS4 Timer	C	4	7784 00015
3244 46011	Water Resistant Stopwatches	LR44	1	7784 01095

NEED HELP? Our experienced customer service representatives are available **CALL 800-456-5624**



▶ SEE PAGE 161
For More
Hand Wipes

Available in
72- or 170-
count bucket.

GOJO® Scrubbing Towels

Formulated to lift heavy dirt and grime from skin pores without dryness or irritation.

- Dual textured; scrubbing side for removing tough soils and a smooth side for quick dirt absorption.
- 72-count bucket features SimPul™ Nozzle Technology, which virtually eliminates roping, providing one towel every time.
- Pre-moistened with a GOJO® heavy-duty cleaning solution.
- Contains skin conditioners to help prevent dryness and irritation.
- For use anywhere heavy-duty cleaning is required; no water needed.



ITEM NO.	PRODUCT	EACH
3540 63965	72-Count Bucket	\$16.91
3540 63985	170-Count Bucket (2 Pack)	66.29

24-Ounce Spray Bottles

- 9-3/4-inch dip tube. • Bottles can easily be marked to identify contents.
- Adjustable spray pattern with full off position. • Chemical resistant.
- Replacement pumps available (sold separately, listed below).



Bottles are labeled with safety information and bilingual check off grid (printed in English/Spanish)

ITEM NO.	PRODUCT	EACH
6710 01205	A. 24-oz. Spray Bottles, Each with Spray Pumps (3-Pack)	\$10.31
6710 02461	B. Replacement Trigger Spray Pump, Red	1.95
6710 00071	C. White Repl. Trigger Sprayer	1.98

Stainless Steel Utility Brushes

Ideal for removing grease and deposits from small and tight areas.

- Stainless steel bristles for aggressive removal of grease.
- Blue plastic handle.

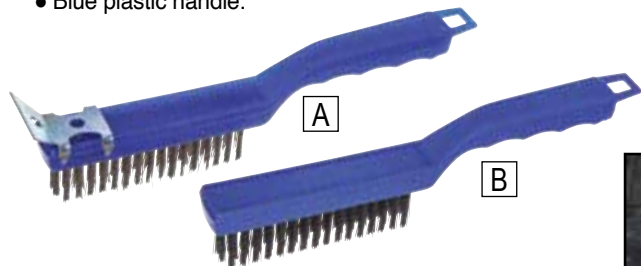

Built-in scraper.



ITEM NO.	PRODUCT	EACH
6387 00501	A. 11-1/2" Utility Brush w/Scraper	\$14.65
6387 67111	B. 11-1/2" Utility Brush w/o Scraper	10.02

Deluxe Carry Caddy



- Holds up to eight 32-ounce spray bottles.
- Ergonomic handle design.
- Dimensions: 15 inches x 11 inches x 7-1/2 inches.



Ideal for carrying cleaning supplies.

ITEM NO.	PRODUCT	EACH
1770 54001	Deluxe Carry Caddy	\$23.65

Toothbrush-Style Utility Brushes

Ideal for cleaning tight, small areas.

- Great for small jobs, tight areas and detail work, small parts, seams, threads and soldered joints.
- 7-inch plastic handle.

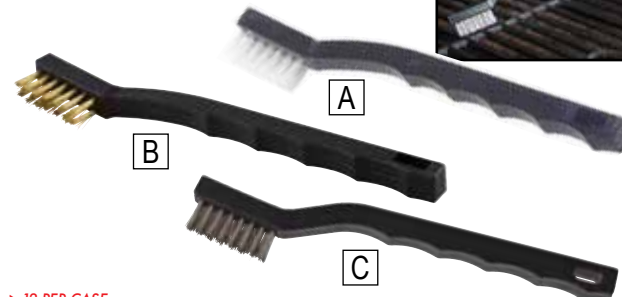

▶ 12 PER CASE.

ITEM NO.	PRODUCT	EACH
6387 74011	A. Nylon Bristles	\$4.46
6387 12701	B. Brass Bristles	4.37
6387 06331	C. Stainless Steel Bristles	4.37

Freezer Kote

- One gallon covers 400 to 500 sq. ft.
- High-gloss finish dries in one hour.
- Suitable for USDA-inspected facilities.
- Coating designed for cold storage application.
- Temperature range: -40 °F up to +190 °F.
- 1 gallon, 10 pounds.
- Color: white.



▶ 4 GALLONS PER CASE.

ITEM NO.	PRODUCT	GALLON
3027 13101	Freezer Kote	\$144.85

Evapo-Rust™ Rust Remover

- Non-toxic, non-corrosive and non-flammable formula removes rust in as little as 5 minutes.
- Easy to use – just immerse rusted part in room temperature biodegradable, water soluble solution, then rinse with water.
- Safe for use in spray cabinets, ultrasonic cleaners, pressure washers, pumps and vats.
- One gallon de-rusts up to 300 pounds of heavily rusted steel.



▶ 4 GALLONS PER CASE.

ITEM NO.	PRODUCT	GALLON
1210 00011	Evapo-Rust	\$40.87



Removes even the deepest of rust in minutes.

Plasti-Dip Liquid-Rubber Coating

- Synthetic rubber coating insulates and protects against moisture, acids, abrasions and reduces skidding/slipping.
- Remains flexible and stretchy over time and will not crack in extreme weather conditions.
- Withstands temperatures from -30 °F to 200 °F. • Resists rust and corrosion.

▶ 4 GALLONS PER CASE.

ITEM NO.	COLOR	GALLON
3176 44751	White	\$106.75
3176 44761	Red	106.75
3176 44771	Black	106.75

NOTE:
This product can NOT be sold in California.



All Purpose Duct Tape

Tears easily by hand and provides ease of application and handling.

- Tightly woven scrim provides high tensile strength.
- Withstands a temperature range of +32 °F to +160 °F.
- 1.88 inches W x 180 feet (48 mm x 54.8 m) per roll.
- Aggressive, synthetic rubber adhesive provides instant adhesion to a wide variety of surfaces.
- Core: 3 inches. • 9 mil • Color: silver.
- Each roll is individually wrapped.

▶ 24 ROLLS PER CASE.

ITEM NO.	PRODUCT	ROLL
3957 49771	1.88" Wide, 48 mm	\$8.95



Scotch® Super 33+™ Vinyl Electrical Tape

Stands up to the elements: from UV rays and moisture to alkalis, acids and corrosion.

- Measures 3/4 inch x 76 feet x 7 mil • Color: black.
- Compatible with rubber and synthetic splicing compounds.
- The tape's pressure-sensitive, rubber-resin adhesive and a durable PVC backing provide great protection.
- UL Listed, ASTM Approved, CSA Certified and RoHS 2011/65/EU Compliant.
- Withstands a temperature range of 0 °F to 221 °F (-18 °C to 105 °C).

▶ 10 ROLLS PER CASE.

ITEM NO.	PRODUCT	ROLL
6655 15681	Super 33+ Vinyl Electrical Tape	\$14.20



NEED ASSISTANCE? 800-456-5624

Our experienced customer service representatives are available to answer your questions, find the products you are looking for, check product availability, as well as take your order.

Bunzl Processor Division

Where Washdown Lighting and 150 psi Meet

- ▶ **See pages 146-150 for our full selection of water nozzles.**
- ▶ **See pages 554-555 for washdown lighting fixtures.**



Little Giant Safety Step Ladders

The go-anywhere, do-anything stepladder.

- Features wide, slip-resistant treads for maximum stability and a fold-up safety bar with integrated tool tray.
- Constructed of rugged, corrosion-resistant aluminum alloy for added durability while remaining portable and light-weight.
- Tip & Glide™ wheels make moving and positioning your ladder easier than ever.
- Choose from 2, 3 or 4-step models.
- 300 pound weight rating.
- 5-inch folded depth.



Tip & Glide™ Wheels.



ITEM NO.	PRODUCT	HEIGHT	SHIPPING WT.	F.O.B. FACTORY	
				SHIPPING WT.	EACH
E373 02101	A. 2-Step Ladder w/Bar.	17" to Top Step	18 lb.		\$194.79
E373 0310	B. 3-Step Ladder w/Bar and Tray	26" to Top Step	24-1/2 lb.		268.07
E373 0410	C. 4-Step Ladder w/Bar and Tray	34" to Top Step	31-1/2 lb.		389.90

Fiberglass Step Ladder



- Heavy gusset bracing.
- Molded top with handyman's tool slots.
- Pinch-resistant spreader braces.
- Slip-resistant rubber feet.
- Duty rated at 300 pounds.



ITEM NO.	SIZE	SHIPPING WT.	EACH
3333 3016	4 ft.	14 lb.	\$121.95
3333 3017	6 ft.	20 lb.	161.05
3333 3018	8 ft.	26 lb.	213.25
3333 3019	10 ft.	37 lb.	322.25
3333 3020	12 ft.	46 lb.	399.25

Multi-Purpose Aluminum Ladder

Four different ladder types in one — can be used as a twin step ladder, stairway ladder, scaffold and an extension ladder.

- Light-weight aluminum design. • Quick activating flip and snap-lock hinges.
- Provides wider footprint for stability and versatility for the most demanding projects.
- One man set-up. • Slip resistant rubber feet.
- Available in: 13-, 17- or 22-foot heights
- Load capacity: 300 pounds.



Ladder adjusts easily to be used in a variety of environments.

► WWW.BUNZLPD.COM
For More Ladders



Extend ladder fully for use in high location needs.

ITEM NO.	SIZE	STRAIGHT EXTENSION	TWIN STEPLADDER	STAIRWAY LADDER	PLANK SUPPORT	SHIPPING WT.	F.O.B. FACTORY	
							SHIPPING WT.	EACH
3333 00161	13 ft.	7'-11'	3'-5'	3'-5'	1'-2'	35 lb.		\$351.25
3333 00171	17 ft.	9'-15'	4'-7'	4'-7'	1'-4'	42 lb.		407.65
3333 00181	22 ft.	11'-19'	5'-9'	5'-9'	1'-5'	50 lb.		449.95

5-Drawer Mobile Work Center

A place for everything at a reasonable price.

- Cart weighs only 77 pounds.
- Work top supports up to 250 pounds.
- 5 metal drawers conveniently hold all your tools and supplies.
- Built-in tool and parts holder, cord wrap and conversion table.



For Locks ► SEE PAGE 280

Locking bar provides security and holds drawers securely in place when moving.



Built-in peg board.

2-inch thick wheels with casters provide easy rolling portability; two of the casters have locks for safety.



ITEM NO.	PRODUCT	DIMENSIONS	EACH
1770 3488	5-Drawer Work Center . . .	32-3/5" x 19-4/5" x 33-1/2"	\$760.45

TradeMaster® Mobile Work Centers



- All-plastic design provides easy maintenance and quiet operation without rusting, denting, chipping or peeling.
- Molded in storage compartments and cup holder to keep tools accessible and organized.
- Raised ergonomic handle reduces wrist and back strain.
- Rounded corners help protect walls, doorways and furniture.
- 4 inch deep drawers with ball bearing slides allows for easy opening and closing.
- 3-outlet, surge-protected power strip with 10 foot cord and wrap.
- (A) Capacity: 750 pounds. • (B) Capacity: 500 pounds.
- Locking 5-inch non-marking casters.
- Top shelf can hold refuse bin (optional). • Ships knocked down.



Cabinet doors swing 270° for easy access and a heavy-duty cam locking system.



ITEM NO.	PRODUCT	DIMENSIONS	F.O.B. FACTORY EACH
1770 4533	A. 4 Drawers w/Cabinet . . .	49" L x 26-1/4" W x 38" H.	\$1,631.25
1770 1388	B. 4 Drawers	40-3/5" x 18-2/5" x 33-2/5"	1,095.95
1770 53881	C. Optional Refuse Bin		128.45

Knobby Mats™

- Economic rubber mats designed for heavy wear and tear in almost any environment. • FDA compliant.
- Use as an anti-fatigue mat or for equipment protection on utility carts, shelving and work stations.
- Knobby surface on both sides allows for circulation of air or liquid to prevent bacterial growth.
- One side of the mat is solid black or has an "X" for quick side identification. • Non-skid surface.
- Mats have 3/4-inch reinforced holes die-cut in 2 corners for easy hanging. • 21 inches x 27 inches.

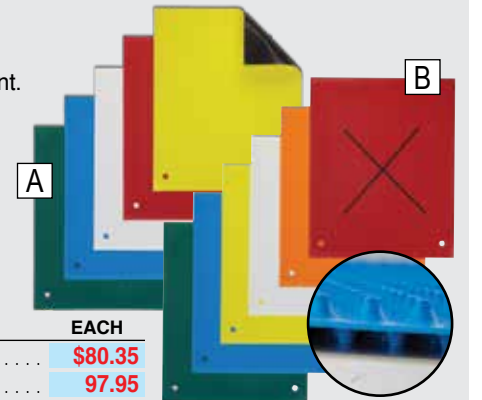

RED	ORANGE	YELLOW	BLUE	GREEN	WHITE	PRODUCT	EACH
ITEM NO.	ITEM NO.	ITEM NO.	ITEM NO.	ITEM NO.	ITEM NO.		
E531 1128	---	E531 2027	E531 2127	E531 2700	E531 00041	A. Mat with Black Back	\$80.35
E531 27291	E531 00271	E531 90271	E531 0001	E531 0002	E531 27281	B. Mat with "X" on Back	97.95

Sahara Pro X3 TurboDryer

Incredibly powerful static pressure and huge CFM volumes!

- Daisy-chain capability with built-in power outlet and circuit breaker.
- Low amp draw – 4 amps max!
- Excellent versatility with 3 speeds and 3 operating positions – 0°, 45° and 90°.
- Underside drying vent for drying under the airmover.
- Quick disassembly for cleaning.
- Rated airflow: 2700 CFM (4587 CMH).
- CFM/amp: 235.
- Static pressure: 1.28 inches (3.25 cm).
- CFM per 15 amp circuit: 2817 CFM, tested.
- Airflow velocity: 2,071 feet/minute (631 m/minute), tested.



CFM stands for “cubic feet per minute” and is a measure of air flow capability.
 Example: a 1000 CFM blower or fan can move air from an area 10 feet x 10 feet x 10 feet in one minute.



3-Position air flow allows air to be directed where you need it.

ITEM NO.	PRODUCT	DIMENSIONS	EACH
F169 0351	Sahara Pro X3 TurboDryer	18.3" x 17" x 18-4/5"	\$424.15

Stainless Steel Food Service Fans

Designed to withstand moist/wet environments, high-pressure cleaning with concentrated caustic solutions without affecting performance or function.

- Constructed with electropolished 304 stainless steel.
- Meets USDA and NSF requirements for food zones.
- All stainless steel motor. • Non-oscillating.
- Motor washdown specification is IEC-IP55.
- Available in non-adjustable pedestal or wall mount.
- 1 phase, TENC, ball bearing, BISSC Approved motor.
- 20-inch fan: 115 V, 1/15 hp, 2 speed.
- 24-inch fan: 115/230 V, 1/4 hp, 1 speed.
- 30-inch fan: 115/230 V, 1/3 hp, 1 speed.
- UL/CUL listed.

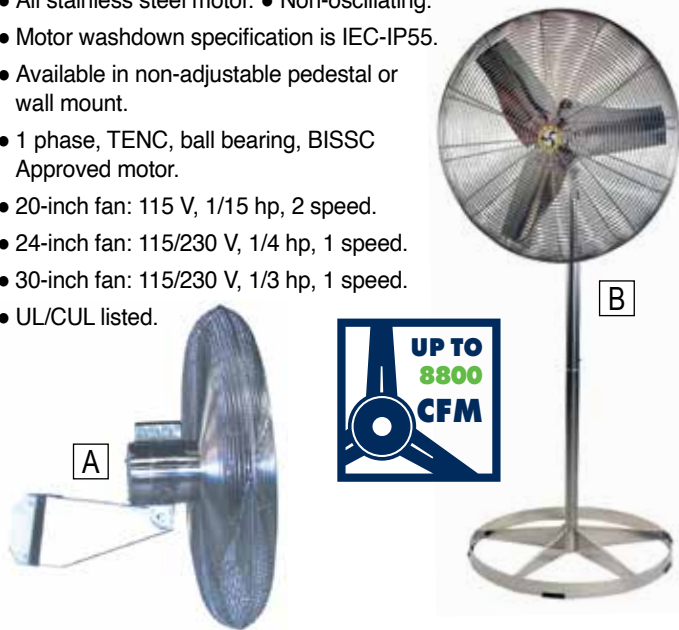

ITEM NO.	PRODUCT	CFM		HP	SHIP WT.	F.O.B. FACTORY EACH
		HIGH	LOW			
F011 0833	A. 20" Wall	2670	1670	1/15	.52 lb.	\$2,409.92
F011 0835	24" Wall	5220		1/4	.62 lb.	6,163.13
F011 0767	30" Wall	8800		1/3	.64 lb.	3,128.51
F011 0834	B. 20" Floor	2670	1670	1/15	.69 lb.	5,818.73
F011 0836	24" Floor	5220		1/4	.79 lb.	2,863.32

Industrial Air Pivot Fans

- Four position easy reach switch with 10-foot three conductor cord and plug.
- 115 V, 1 phase, 3 speed, open drip proof, ball bearing motor.
- Nickel chrome guards meet OSHA requirements.
- Choose from yoke mount, low or high stand. • Aluminum propellers.
- Adjusts 360°. • UL/CUL listed.



NOTE: Yoke mount attaches to any surface with one bolt or lag screw (not included).

ITEM NO.	PRODUCT	CFM			HP	F.O.B. FACTORY EACH
		HIGH	MED	LOW		
F011 89741	A. 18" Low Stand	2966	2437	2013	1/8	\$219.91
F011 89751	20" Low Stand	3390	2755	2295	1/5	221.03
F011 89721	B. 18" Yoke Mount	2966	2437	2013	1/8	212.15
F011 89701	20" Yoke Mount	3390	2755	2295	1/5	235.21

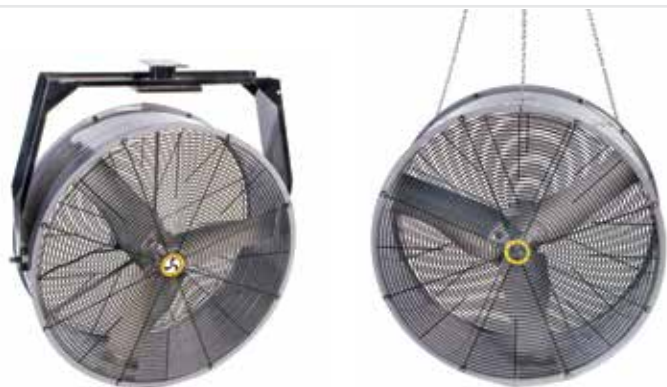

Ceiling Mount

Hanging Mount



Portable Barrel

Wall Mount

4-in-1 Direct Drive Fan

One fan with four mounting options (mounts included)!

- 30-inch fan: 1/4 hp, 115 V, 1 phase, ball bearing motor, 3 speeds.
- 36-inch fan: 1/2 hp, 115 V, 1 phase, ball bearing motor, 2 speeds.
- Epoxy coated guards, barrel and mountings.
- Shipping weights: 30-inch fan = 97 pounds; 36-inch fan = 119 pounds.
- Tilttable. • Pull chain switch. • UL/CUL listed.

30-inch Fan

36-inch Fan



ITEM NO.	PRODUCT	CFM			HP	EACH
		HIGH	MED	LOW		
F011 0470	30" 4-in-1 Fan	5670	4590	3410	1/4	\$755.19
F011 00051	36" 4-in-1 Fan	11200		8090	1/4	1,873.75

42-Inch Belt Drive Drum Fan

Powerful fans for moving a large amount of air.

- 115 V, 1 phase, 2 speed, ODP, 1/2 hp motor.
- Guards, barrel and propellers epoxy coated.
- Three bladed aluminum propeller. • Two speed rocker switch.
- 8-inch steel wheels with rubber tires. • Handle with cord wrap.
- Dimensions: 46-inch cabinet size. • Shipping weight: 130 pounds.
- 10-foot, three conductor SJT type cord. • UL/CUL listed.



ITEM NO.	PRODUCT	CFM		HP	EACH
		HIGH	LOW		
F011 6002	42" Belt Drive Fan	14000	8000	1/2 (2SP)	\$2,560.73

Industrial Grade Fan Components

Customizable to the needs of your plant.



- A. Non-oscillating fan head available in 20 inch, 24 inch or 30 inch and includes 15-foot cord with 3-prong plug
- B. Solid pedestal base available in 26 inches or 32 inches.
- C. Wall/ceiling mount bracket includes safety cable kit.
- D. Snap-on wheel kit with set screw lock fits 20- to 30-inch pedestal fans.
- E. Adjustable pole allows fan to be used from 5 to 8 feet.



ITEM NO.	PRODUCT	CFM			HP	F.O.B. FACTORY EACH
		HIGH	MED	LOW		
F011 71141	A. 20" Fan Head	2670	---	2035	27 lb.	\$366.57
F011 15901	24" Fan Head	4400	3460	2460	1/4	397.68
F011 15911	30" Fan Head	6100	4400	2700	1/4	409.90
F011 11651	B. 26" Dia. Solid Pedestal Base					422.05
F011 11661	32" Dia. Solid Pedestal Base					198.73
F011 50021	C. Wall/Ceiling Mount Bracket					118.11
F011 06011	D. Pedestal Wheel Kit					249.96
F011 00071	E. Adjustable Pole, 5' to 8'					170.34

Magna-Plate Food Grade Grease

For use on machinery where grease may come into contact with edible product.

- White grease has excellent water-resistance and lubrication qualities.
- Good oil bleed characteristics at low ambient temperatures make it ideal for small, high-speed bearings.
- Standard grease is for temperatures under 250 °F (121 °C).
- High-Temp grease is for temperatures 500 °F (260 °C).
- Fits standard hand-operated grease gun.



▶ 10 PER PACK.

ITEM NO.	PRODUCT	EACH
5484 10501	14.5 oz., Standard	\$16.45
5484 20521	14.5 oz., High-Temp	16.25

Clear-Guard Food Grade Grease

For use on machinery where grease may come into contact with edible product.

- Clear grease compounded with a high-temperature polymer clings to metal surfaces under the most severe conditions.
- Water, salts, heat and chemicals will not affect performance.
- Resists sling and channeling under high-speed or high-temperature conditions.
- Fits standard hand-operated grease gun.



▶ 10 PER PACK.

ITEM NO.	PRODUCT	EACH
5484 20011	14.5 oz. Tube	\$18.70

BDF Cling-Lube

For use on overhead chains, conveyors trolleys and way guides in meat and poultry processing plants.

- Contains MICRONOX® Technology*.
- High-cling, thick foaming, non-drip, overhead lubricant.



▶ 12 PER CASE.

ITEM NO.	PRODUCT	EACH
5484 02141	11 oz. Aerosol	\$17.00

Food Grade Anti-Seize Compound

Prevents galling seizure, corrosion, wear and friction on fasteners, threads and joints.

- Apply with built-in cap brush to clean surface.
- Non-toxic, clean white color.
- Taste- and stain-free and kosher.



▶ 12 BOTTLES PER CASE.

ITEM NO.	PRODUCT	EACH
5484 01341	Food Grade Anti-Seize, 8 oz. Jar	\$18.70

Heavy-Duty Industrial Grease Gun

Heavy-duty cast iron head with cadmium plated toggle and lever.

- Exclusive "Flip-Over" follower allows a superior seal for either cartridge or bulk loading applications.
- Jam-proof toggle mechanism prevents binding or bending of plunger.
- Precision-fit plunger prevents lubricant bypass and resists scoring.
- Extra-heavy follower spring ensures positive priming and uninterrupted pumping action.
- Lube Capacity: 16 ounce bulk; 14-1/2-ounce cartridge.



ITEM NO.	PRODUCT	LENGTH	EACH
3538 1142	Grease Gun	21-1/4"	\$84.87

USDA-NSF AUTHORIZATION CODES

FOOD GRADE CATEGORY	APPLICATION
A1	General cleaning products
A7	Metal cleaners and polishes for non-food contact surfaces.
H1	Lubricants with incidental food contact.
H2	Lubricants with no food contact.
3H	Lubricants with direct food contact.
P1	Compounds requiring a letter for authorized use.

Zerk Replacement Kit

- 100 assorted grease gun fittings in all popular sizes.



ITEM NO.	PRODUCT	F.O.B. FACTORY EACH
3538 6643	Zerk Replacement Kit	\$141.52

Dry-Glide All Purpose Silicone

For food packaging machinery, friction areas for films, wraps, cartons and large flat areas where a no-stick surface is needed.

- Food grade quick dry silicone lubricant can be used in all sanitary food plant applications.
- High silicone content, so there is little need to reapply as often – saving time and money.
- Available in a trigger spray bottle or as an aerosol.



▶ 12 SPRAY BOTTLES W/ONE TRIGGER SPRAYER PER CASE.
▶ 12 AEROSOL CANS PER CASE.

ITEM NO.	PRODUCT	EACH
5484 00021	16 oz. Trigger Spray	\$18.30
5484 01081	10 oz. Aerosol	17.95
5484 04001	Trigger Sprayer Only	5.80

Magna-Plate 74 Air Tool/Air Line Oil

Food grade oil for use on industrial air lines.

- Rust inhibitors help provide trouble-free operation of any air line system.
- Emulsifies exhaust system moisture.
- Premium additives protect internal components.
- Contains MICRONOX® Technology.*



▶ 12 BOTTLES PER CASE.

ITEM NO.	PRODUCT	EACH
5484 00091	16 oz. Bottle	\$14.50

Magna-Plate 78 Anti-Wear Food Grade Lubricant

For use on chains, slides, ways, bearings conveyors and food processing and packaging equipment.

- Food grade machinery oil should be used where there is a chance of incidental food contact.
- Contains MICRONOX® Technology.*
- Available in a trigger spray bottle or as an aerosol.



▶ 12 SPRAY BOTTLES W/ONE TRIGGER SPRAYER PER CASE.
▶ 12 AEROSOL CANS PER CASE.

ITEM NO.	PRODUCT	EACH
5484 00041	16 oz. Trigger Spray	\$15.65
5484 00031	11 oz. Aerosol	17.55
5484 04001	Trigger Sprayer Only	5.80

Halo-Guard FG-2

- “Extreme Pressure” high-performance, high-temperature food machinery grease has oxidation stability and performance.
- Excellent rust and corrosion control.
- Water washout and chemical resistance.
- Contains MICRONOX® Technology.*



▶ 12 PER CASE.

ITEM NO.	PRODUCT	EACH
5484 00071	11 oz. Aerosol	\$18.10

PürGel Klear

For applications where direct food contact is certain or likely.

- Resists and retains moisture and creates a seal.
- For use on valves, rings, seals and gaskets.
- Great assembly paste of pumps.
- Pure, clean petrolatum. • NSF registered.



▶ 12 PER CASE.

ITEM NO.	PRODUCT	EACH
5484 40021	8 oz. PürGel Squeeze Tube	\$15.80

Food Grade Penetrating Oil

Used by canners, dairies, meat packers, bottlers and bakers.

- Blend of the finest oils, solvents, wetting agents and molybdenum disulfide formulated to penetrate and loosen more effectively than a torch.
- Excellent spray-down oil to help eliminate rust after pressure washing or steam cleaning.
- Loosens corroded fasteners and speeds and protects during disassembly or retooling.
- Available in a trigger spray bottle or as an aerosol.



▶ 12 SPRAY BOTTLES W/ONE TRIGGER SPRAYER PER CASE. ▶ 12 AEROSOL CANS PER CASE.

ITEM NO.	PRODUCT	EACH
5484 00051	16 oz. Trigger Spray	\$16.80
5484 00061	11 oz. Aerosol	16.55
5484 04001	Trigger Sprayer Only	5.80

* Micronox® food grade antimicrobial technology for product protection. JAX USDA/NSF authorized H1 lubricants containing Micronox incorporate proprietary food additive antimicrobial agents that provide antimicrobial protection to the lubricant from contamination as a result of indirect contact with processed foods or beverages. Use of this product is not a substitute for proper sanitation processes and protocols. Micronox® products contain an odor.

Food Grade White Mineral Oil

Fast and easy way to clean, lubricate and protect electric and manual food processing equipment.

- Authorized by USDA for use in federally inspected meat and poultry plants.
- Can also be used for the lubrication of abrasive stones used for sharpening knives.
- Contains no GMO's. Kosher and VEGAN certified, gluten and allergen free, free of any VOC's and carries BSE/TSE statement.
- Suitable for use on food machinery and equipment.
- Non-toxic and tasteless.



FOOD GRADE
3H

ITEM NO.	PRODUCT	EACH
J134 00011	A. 32-oz. Bottle w/Sprayer (12/Case)	\$11.40
J134 00021	B. 1-Gallon Bottle/Jug (4/Case)	28.05
J134 0003	C. 5-Gallon Bucket	118.50
J134 0004	D. 55-Gallon Drum	978.60



Pump Dispensers for Gallon Bottles

- Pumps from 1/4 ounce to 1 ounce increments.
- Pump fits any 1-gallon bottle.

ITEM NO.	PRODUCT	EACH
6710 61001	1 oz.	\$2.95
6710 11091	0.25 oz.	3.07

SHOP 24/7

bunzlpd.com

CHAT

Need Help?

Chat With Us Online!

STAY CONNECTED WITH US:

Sure Shot Sprayer

Excellent for use with mineral oils.

- Black anodized aluminum canister is refillable and rechargeable.
- Filler cap stem fits standard compressed air chuck.
- Spring loaded trigger for easy volume control.
- Includes adjustable spray nozzle rated for use up to 200 psi.

ITEM NO.	PRODUCT	EACH
3573 24011	24 oz. Canister	\$144.56

PRICES ARE SUBJECT TO CHANGE • MINIMUMS MAY APPLY • VISIT WWW.BUNZLPD.COM FOR CURRENT PRICING.

Heavy-Duty Stainless Steel Faucet



- FM approved for use with oils (under 30 SAE) and non-flammables, compatible with stainless steel. Adjustable shank designed to easily adjust to proper drain position after installing in drum.
- Internal flame arrestor.
- 3/4-inch NPT connection.
- PTFE gasket.



ITEM NO.	PRODUCT	EACH
7447 20381	Heavy-Duty Stainless Steel Faucet	\$302.84

Zinc Die-Cast Drum Faucet



- No flame arrestor.
- Easy to use self closing faucet.
- Can be padlocked in closed position.
- Nylon gasket, 3/4 inch NPT connection.
- FM approved for viscous liquids only.



ITEM NO.	PRODUCT	EACH
7447 2080	Die-Cast Faucet	\$33.32

Rotary Drum Pump



- Rugged cast iron construction.
- Durable phenolic veins.
- Self-priming. • Weight: 15 pounds.
- 48-inch PVC discharge tube.
- Three piece plated suction tube — 47 inch assembled.



ITEM NO.	PRODUCT	EACH
7447 0021	Rotary Drum Pump	\$162.18

Hand-Operated Piston Drum Pump

- Not for use with corrosive chemicals. • 8 oz. output.
- Chrome plated steel. • 2-inch IPS adapter.
- Fits standard 15-, 30- and 55-gallon drums.
- Compatible with cleaning solutions and many solvent-based products.



ITEM NO.	PRODUCT	EACH
6710 01051	Piston Drum Pump	\$58.95

Stainless Steel Drum Dolly



- Greater stability from strategically placed casters.
- 304 stainless steel construction with reinforced outriggers.
- Four swivel white polypropylene and stainless steel casters.
- Suitable for washdown applications.
- Dimensions: 24 inches ID.
- Weight: 22 pounds.
- Capacity: 1,000 pounds.



ITEM NO.	PRODUCT	SIZE	EACH
7447 0197	SS Drum Dolly55 Gallon	\$506.03

Drum Wrench



- Constructed of spark-proof bronze.
- Offset handle reduces knuckle injury.



ITEM NO.	PRODUCT	SIZE	EACH
7447 2018	Drum Wrench	12" Length.	\$69.05

Chrome-Plated Drum Pump

- Fits standard 15-, 30- and 55-gallon drums with 2-inch standard FIP fittings.
- Self-priming pump dispenses 22-ounce per stroke.
- Chrome plating protects metal from the corrosive effects of water-based solutions.
- Teflon® coated packing seal increases chemical resistance.



ITEM NO.	PRODUCT	SIZE	EACH
6710 00261	Drum Pump41-3/8" x 1-7/16"	\$46.95

Plastic Drum Pump

- Chemical and acid-resistant in design.
- Adjusts to dispense 2, 4, 6 or 8 ounces per stroke.
- Fits both 5-gallon pail with Rieke Senior Flexspout and 15, 30 or 55-gallon drums with 3/4-inch or 2-inch standard FIP fittings.
- All necessary adaptor fittings included.



ITEM NO.	PRODUCT	SIZE	EACH
6710 01501	Plastic Drum Pump	48" x 3/5" Dia.	\$20.95

Universal Poly Spill Kit

Absorption and disposal in one kit.

- Designed to meet OSHA 29 CFR 1910.120 in a U.N. approved 6-1/2 gallon disposal container.
- Kits absorbs up to 5 gallons of spilled liquid.



Spill Kit includes:

(10) Fiberlink Heavy-Weight Pads,
15 inches x 18 inches

(3) Fiberlink Absorbent Socks,
3 inches x 4 inches

(2) Disposal Bags and Ties

(2) Hazmat Waste Labels

Pair of Nitrile Gloves

Pair of Splash Goggles

Dust Mask

ITEM NO.	PRODUCT	EACH
6017 06001	6-1/2 Gallon Spill Kit	\$96.13

Hazmat Absorbent Socks

- Absorbent FiberLink fiber encased in a yellow polyfill fabric for the absorption of both oil and water based liquids.
- Color helps warn of hazardous conditions.
- Size: 3 inch diameter x 4 feet L.



ITEM NO.	PRODUCT	ABSORB CAPACITY	CASE
6017 0344	Case of 4, HazMat Socks	5 Gallon	\$23.39
6017 3410	Case of 10, HazMat Socks	12-1/2 Gallon	58.93
6017 3420	Case of 20, HazMat Socks	25 Gallon	118.09
6017 3441	Case of 40, HazMat Socks	50 Gallon	223.04

Universal Absorbent Socks

- Environmentally friendly and safe to use.
- Made of 100% absorbent fiber filling in a durable polypropylene sleeve.
- Universal socks can be reused or incinerated.
- Size: 3 inch diameter x 4 feet L.



ITEM NO.	PRODUCT	CASE
6017 0004	Case of 4, Absorbent Socks	\$17.47
6017 0001	Case of 10, Absorbent Socks	40.96
6017 0035	Case of 20, Absorbent Socks	80.00
6017 3440	Case of 40, Absorbent Socks	149.44



Absorbent Drum Cover Pads

- Diameter: 22 inches.
- Made of sturdy, dimpled, heavy-weight poly material.
- Absorb leaks and drips from storage drum pumps and faucets.
- Pump perforation allows easy fit and removal from standard drum tops.



▶ 25 PER CASE.

ITEM NO.	PRODUCT	COLOR	CASE
6017 00475	A. Universal Heavy-Weight	Gray	\$111.63
6017 00465	B. Oil Only Heavy-Weight	White	154.87

Oil-Only Poly Spill Pads

- Absorbs petroleum products while repelling water-based liquids.
- Absorbs 15 gallons. • Perforated for easy tear. • Bonded for durability.
- Heavy-weight. • Size: 15 inches x 18 inches. • Color: white.



▶ 100 PADS PER BALE.

ITEM NO.	PRODUCT	BALE
6017 0012	Poly Spill Pads	\$68.92

Universal Heavy-Weight Spill Pads

- Designed to pick up spills on contact, stop liquids from running, and prevent tracking in the workplace.
- Absorbs up to 15 gallons per bale.
- Dark gray color helps hide grease and grime.
- Size: 15 inches x 18 inches.



▶ 100 PADS PER BALE.

ITEM NO.	PRODUCT	BALE
6017 1012	Poly Spill Pads	\$87.75

Spill Hero Absorbent Pads

Easy, fast and simple spill response.

- Absorbent pad for quick response to nuisance spills.
- Sealed pouch with non-permeable top layer and super-absorbent polymers.
- Pad size: 6-3/4 inches x 7 inches.



▶ 536 PADS PER CASE.

ITEM NO.	PRODUCT	CASE
6017 00523	Absorbent Pads	\$206.51



XSORB Universal Super Absorbent

The safe, easy and economical spill clean up.

- Absorbs 7-1/2 times more than clay — up to 14 gallons per box
- More economical than paper towels. • Accepted by landfills — non-leaching.
- Absorbs oil and water based liquids. • Quick absorption for fast clean up.
- Light-weight and easy to handle. • Leaves surface dry and slip free.
- Non-toxic and environmentally friendly.
- Meets USDA, FDA and EPA requirements.
- Plastic bottles with screw-on caps designed to fit in the Spill Station (left).
- Use the 25-pound box to easily refill your bottles, saving time and money and reducing waste.



XSORB Spill Station



Disposable bags and instructions.



Scan this QR Code with your mobile device to watch a video about XSORB Spill Kit.

Spill Kit includes:

- (1) 6-Quart Bottle of XSORB Universal Absorbent
- (1) Long-Handled Broom
- (1) Dustpan and Brush Set
- (1) Wire Rack
- (50) Disposal Bags
- Instruction Label

ITEM NO.	PRODUCT	EACH
6017 00071	Spill Station . .	\$97.50

▶ 4 BOTTLES PER CASE.

ITEM NO.	PRODUCT	WT.	CASE
6017 0036	6 qt. Bottles	10 lb.	\$54.86

ITEM NO.	PRODUCT	BOX DIMENSIONS	BOX
6017 0025	25 lb Box	16-1/2" x 14" x 22-1/4"	\$38.54

Spill Hero Biohazard Clean-Up Kit

Biohazard Clean-Up Kits are for the absorption, handling and disposal of biohazardous spills.

- Easily cleans up biohazard accidents such as vomit, blood and other body fluids while treating the spill with a powerful disinfecting agent.
- Each kit can absorb up to one quart.
- Please refer to the Health and Safety Code regulations in your area for proper handling of biohazardous spills.

Kit includes:

- (1) 2-oz. Packet of XSORB Plus Absorbent with Disinfectant
- (1) Disinfecting Towelette
- (2) Antiseptic Towelettes
- (2) Paper Towels
- (2) Plastic Scrapers
- (1) Facemask with Eyeshield
- (1) Pair High-Risk Protective Gloves
- (2) Clear Disposal Bags
- Complete Instructions



ITEM NO.	PRODUCT	EACH
6017 0712	Biohazard Clean-Up Kit.	\$147.09

FREE SHIPPING*

FREE GROUND SHIPPING

when you place an order for \$500 or more from THIS BUYERS GUIDE!

*FREE SHIPPING does NOT include UPS Next Day Air, UPS 2nd Day or UPS 3rd Day Select. Certain items may not qualify. This offer is good only on orders shipped UPS Ground in the 48 contiguous states. Based on dimensional weight, we will determine the most efficient means of shipment, either UPS or LTL. Products may ship by truckline.

Safety Sorbent Non-Slip Floor Compound

Instant traction on slippery floors.

- Sprinkle over floors, walkways and work areas where water, grease or oil accumulate.
- Contains no sawdust, won't hold odors.
- Sweep or hose down at the end of each day.



ITEM NO.	PRODUCT	EACH
7070 0010	2-1/2 lb Carton	\$46.06

ShurFoot Non-Slip Floor Compound

- Absorbs grease, oil and blood.
- 50-pound box.



ITEM NO.	PRODUCT	EACH
3988 0051	50 lb Box	\$43.95

Biofresh™ Disinfecting Absorbent

- Easily cleans up biohazard accidents such as vomit, blood and other body fluids while treating the spill with a powerful disinfecting agent.
- Turns contaminated liquids to solid waste for fast, easy disposal.
- Each canister can absorb and disinfect up to 1/2 gallon of liquid.



ITEM NO.	PRODUCT	EACH
6017 10091	Shaker Canister	\$6.52

PerfectPleat® High Capacity Filters

- Innovative self-supporting design with no metal construction.
- Similar or higher strength than metal-backed filters.
- 1 inch depth.



ITEM NO.	PRODUCT	RATING	MFR. NO.
K358 00125	20" x 20" x 1"	MERV 8	173-700-011

PREpleat® High Capacity Filters

- Low initial resistance for energy efficiency.
- Media backed with heavy-duty galvanized wire for durability.
- High wet-strength beverage board frame.
- MERV 11 efficiencies.
- 4 inch depth.

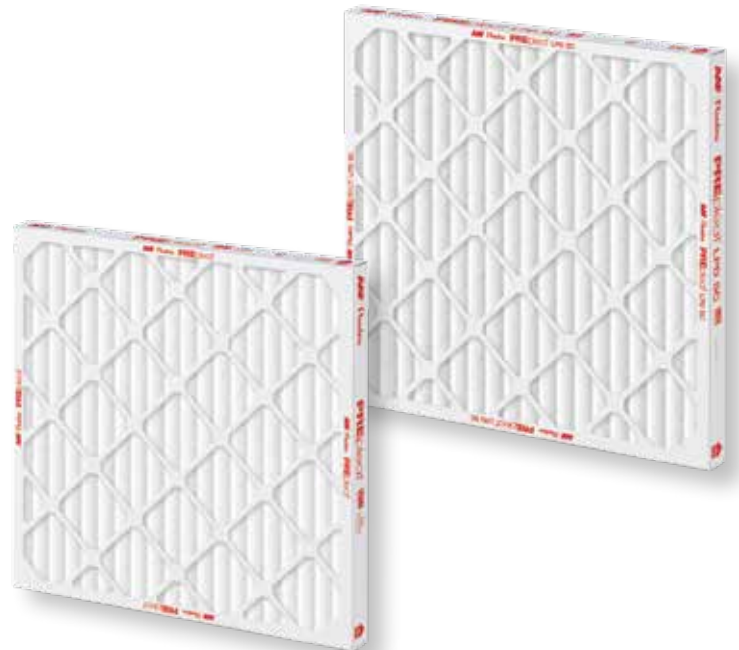

ITEM NO.	PRODUCT	RATING	MFR. NO.
K358 00095	24" x 24" x 4"	MERV 11	85755-042424M11

Additional Sizes Available. CALL 800-456-5624 FOR MORE INFORMATION.

Stainless Steel Sprayers

Heavy-duty stainless steel tanks are built for durability at an economical price.

- Large funnel top for easy filling with a reinforced chemical-resistant hose.
- Adjustable and fan nozzle.
- Features Viton® gaskets and seals.
- Plastic valve with brass extension.
- Plastic pin-to-cone and fan spray tips.
- Available in 2 gallon with 12-inch brass extension or 3 gallon with 18-inch brass extension.
- 40-inch hose.



ITEM NO.	PRODUCT	EACH
4828 25001	2-Gallon SS Sprayer	\$180.45
4828 26001	3-Gallon SS Sprayer	213.75

1, 2 or 3-Gallon Poly Molded Sprayers

- An economical heavy-duty, poly molded design.
- Features Viton® gaskets and seals.
- Funnel top design for ease of filling.
- Braided reinforced hose with durable plastic valve and extension with pin-to-cone spray tip.
- Available in 1 or 2 gallon with 12-inch brass extension or 3 gallon with 18-inch brass extension.
- Adjustable nozzle.
- 30-inch hose.



ITEM NO.	PRODUCT	EACH
4828 00061	1 Gallon Plastic Sprayer	\$35.95
4828 23381	2 Gallon Plastic Sprayer	52.95
4828 24381	3 Gallon Plastic Sprayer	61.95

3-Gallon Economy Poly Molded Sprayer

- An economical heavy-duty, poly molded design.
- Funnel top design for ease of filling.
- Braided reinforced hose with durable plastic valve and extension with pin-to-cone spray tip.
- Color: white.



ITEM NO.	PRODUCT	EACH
4828 00051	3 Gallon Sprayer	\$40.95

Foaming Nozzle

Easily converts sprayers to foamers!

- Attaches to all sprayer nozzles.



ITEM NO.	PRODUCT	EACH
4828 19001	Foaming Nozzle.	\$16.65



SIGN UP FOR OUR eDEALS

Get exclusive offers not found anywhere else!
eDEAL SIGN-UP FORM AVAILABLE ON OUR WEBSITE.

www.bunzlpd.com

iFly Wall-Mounted Stainless Steel Adhesive Traps

Stainless steel commercial grade construction can withstand harsh environments.

- Easy-to-clean. Just replace adhesive trapping boards.
- Easy to install. Built in mounting slots help with mounting and levelling.
- IP65 - dust proof and waterproof. • Energy-efficient UV Insect Lamps.



A. iFly40 Adhesive Trap

- Attraction range: 1,150 square feet.
- UV Light output: 40 Watts. Uses two 24 inch, 20 Watt shatter-coated sleeved bulbs.
- Uses one 12 inch x 22 inch water-resistant glueboard.
- Dimensions: 11 inches W x 28 inches H x 5 inches D.

B. iFly65 Adhesive Trap

- Attraction range: 2,500 square feet.
- UV Light output: 80 Watts. Uses two 48 inch, 40 Watt shatter-coated sleeved bulbs.
- Uses two, 12 inch x 22 inch water-resistant glueboards.
- Dimensions: 11 inches W x 53 inches H x 3 inches D.



Easy bulb and glueboard replacement.



A

THE ONLY 2 FOOT AND 4 FOOT GLUEBOARD FLY LIGHTS THAT ARE BOTH WATERPROOF AND STAINLESS STEEL.

B

ITEM NO.	PRODUCT	EACH
E756 00351	A. iFly40 Stainless Steel Trap.	\$345.25
E756 00361	EL-79 Replacement Glueboards, 12"x22"	3.15
E756 00311	24" Replacement Shatter-Coated Bulb, 20 Watt.	19.95
E756 0033	B. iFly65 Stainless Steel Trap	395.15
E756 00361	EL-79 Replacement Glueboards, 12"x22"	3.15
E756 00341	48" Replacement Shatter-Coated Bulb, 40 Watt.	19.95

Wasp and Hornet Killer

- Jet sprays up to 20 feet, killing pests from a comfortable distance.
- Can be used indoors or outdoors.



▶ 12 PER CASE.

ITEM NO.	PRODUCT	CASE
7507 5839	16 oz. Aerosol Can	\$114.81

SHATTERPROOF BULBS

Labeled shatterproof coating on bulbs forms a protective envelope to minimize the dangers of broken glass and meets auditing standards.



GT-180S Adhesive Trap



Attractive, durable and industrial white, painted steel design.



- Hinged, easy access door allows quick replacement of UV insect lights and glue board adhesive panels.
- Easy-to-clean. Just replace adhesive trapping boards.
- 24-hour, non-chemical trapping.
- Energy-efficient UV Insect Lamps.
- Attraction range: 1,500 square feet (40 lineal feet).
- UV Light output: 30 Watts — two 15-Watt bulbs.
- FDA and USDA accepted under current code.
- Glueboards: (1) 9 inch x 16 inch; (1) 3 inch x 19 inch.
- UL approved/listed.



Patented glueboard roller guides for easy replacement.



ITEM NO.	PRODUCT	EACH
E756 0006	GT-180S Light Trap, 19-1/2" x 3-1/2" x 11-1/2"	\$209.45
E756 00155	EL-63 Replacement Glue Boards, 3" x 19" Black (10 Pack)	18.35
E756 00165	EL-61 Replacement Glue Boards, 9" x 16" White (10 Pack)	35.05
E756 00055	EL-62 Replacement Glue Boards, 9" x 16" Black (10 Pack)	35.05
E756 00081	T8, 18"	13.95

GT-220SS Stainless Steel Adhesive Trap



Open grid emits the maximum amount of light on all sides.



- 24-hour, non-chemical trapping.
- Energy-efficient UV insect lamps.
- Attraction Range: 1,800 square feet (50 lineal feet).
- UV Light output: 40 Watts — two 20-Watt lamps.
- FDA and USDA accepted under current code.
- UL approved/listed, 115 V/60 Hz, with 6-foot cord.



Flip-open front fits 5-inch x 22-inch glueboard.

ITEM NO.	PRODUCT	EACH
E756 0010	GT-220S Stainless Steel Light Trap, 24-3/4" x 3-3/4" x 9"	\$248.15
E756 00045	EL-58 Replacement Glue Boards, 5" x 22" White (24 Pack)	41.95
E756 00175	EL-59 Replacement Glue Boards, 5" x 22" Black (24 Pack)	41.95
E756 00311	EL-07T820S, 24"	19.95

GT-215SS Slimline Adhesive Trap



Thin design with stainless steel front that conceals insects while maintaining effectiveness.



- Position 5-6 feet above the floor for best results.
- Stainless steel finish.
- 24-hour, non-chemical trapping.
- Energy-efficient UV Insect Lamps.
- Attraction range: 1,500 square feet (40 lineal feet).
- UV Light output: 30 Watts.
- 115 V/60 Hz, with 6-foot cord.



Choose from black or white glueboards



ITEM NO.	PRODUCT	EACH
E756 0012	GT-215SS, Stainless Steel, 18-3/4" x 2.3" x 12"	\$215.85
E756 00165	EL-61 Replacement Glue Boards, 9" x 16" White (10 Pack)	35.05
E756 00055	EL-62 Replacement Glue Boards, 9" x 16" Black (10 Pack)	35.05
E756 00081	T8, 18"	13.95

GT-480S Industrial Adhesive Trap



For use in shipping/receiving areas and food production facilities where flying insect activity is high.



- Utilizes 3 large adhesive insect trapping boards for maximum capacity.
- Patented roller guides for easy replacement.
- 24-hour, non-chemical trapping.
- UV Light output: 80 Watts.
- Attraction range: 3,500 square feet.
- Easy open front door.
- 432 square inches of trapping surface.
- White, painted steel design.

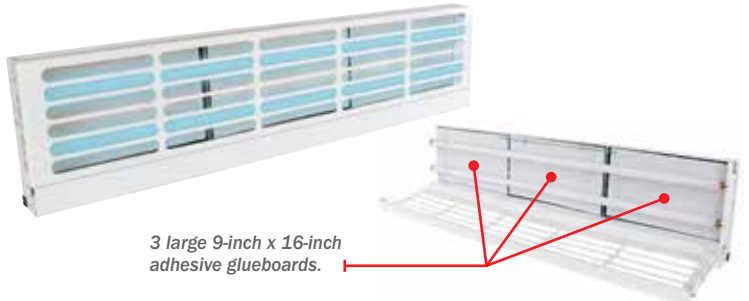

ITEM NO.	PRODUCT	EACH
E756 0001	GT-480S Industrial Light Trap, 48-3/4" x 3" x 11-1/2"	\$339.95
E756 00165	EL-61 Replacement Glue Boards, 9" x 16" White (10 Pack)	35.05
E756 00055	EL-62 Replacement Glue Boards, 9" x 16" Black (10 Pack)	35.05
E756 00341	EL-09T840S, 48"	19.95

Silicone Smokehouse Gasket

- Replacement smokehouse gasket. • Maximum temperature: 450 °F.
- Available in 25-, 50- or 100-foot rolls. • Size: 1 inch x 2 inch.



Cross section closeup.



▶ 25 FEET PER ROLL

ITEM NO.	PRODUCT	ROLL
3538 1543	Non-Adhesive	\$32.07
3538 1544	Adhesive	36.03

Neoprene Gasket

- Temperature range: -40° to 130 °F.
- Size: 1/2 inch x 1-1/4 inch x 25 feet.
- Closed-cell.



Cross section with adhesive backing



NOTE: More sizes available.

ITEM NO.	LENGTH	ROLL
3538 01211	25 ft.	\$424.55
3538 01221	50 ft.	846.40
3538 8469	100 ft.	1,439.25

Neoprene Refrigeration Gasket, Black

- Easy to fit, cut and shape for custom gasketing and sealing applications.
- Size: 13/16 inch x 2-3/4 inch x 25 feet.



P-shaped cross section closeup.

▶ 25 FEET PER ROLL

ITEM NO.	PRODUCT	ROLL
3538 2452	Neoprene, Black	\$127.33

Neoprene Refrigeration Gasket, White

- Size: 7/8 inch x 2-3/4 inch x 25 feet.



P-shaped cross section closeup

▶ 25 FEET PER ROLL

ITEM NO.	PRODUCT	ROLL
3538 0962	Neoprene, White	\$98.95

Sewn Fabric Over 3/4-Inch PVC

- Replacement gasket for sliding doors and frames.
- Size: 3/4 inch dia. x 1-1/4 inch x 25 feet.



▶ 25 FEET PER ROLL

ITEM NO.	PRODUCT	ROLL
3538 1542	PVC/Fabric	\$241.84

Silicone Caulk/Sealant

- Meets FDA and USDA requirements for use in federally inspected meat and poultry plants.
- Effective operating range: -60 °F to 400 °F.



▶ 24 PER CASE.

ITEM NO.	PRODUCT	EACH
3470 03701	Clear Caulk, 13.3 fl. oz.	\$10.95

Rubberized Silicone Sealant

- Will not crack, crumble or dry out.
- Temperature range: -70 °F to 400 °F.
- Meets FDA and USDA requirements for use in federally inspected meat and poultry plants.



▶ 12 PER CASE.

ITEM NO.	PRODUCT	EACH
3149 12881	White, 11 oz.	\$11.05
3149 12891	Clear, 11 oz.	13.95

Multi-Purpose Adhesives

- Specially formulated for bonding fiberglass reinforced plastic to various substrates.
- Fast setting and resistant to temperature changes.



ITEM NO.	PRODUCT	EACH
3149 1359	11-oz. Tube	\$7.25
3149 0006	4-Gallon Pail, Latex-Based	110.25

Overnight Concrete Floor Patch Kit

- For temperatures as low as 50 °F.
- Gray sand/epoxy patch.
- Kit covers 15 sq. ft. x 1/4 inch thick.
- Instruction and mixing kit included.



ITEM NO.	PRODUCT	EACH
3117 3509	Floor Patch Kit	\$147.24

Ergo Stands

Help level the height difference among workers at shared workstations — creating a comfortable, ergonomic working position.

- Punched anti-slip deck for maximum traction reduces slips and falls from wet or slippery floors.
- Constructed of solid, fully welded rust-free aluminum.
- Available in 5 heights.

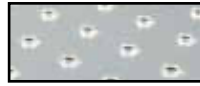

Anti-slip deck for maximum traction.

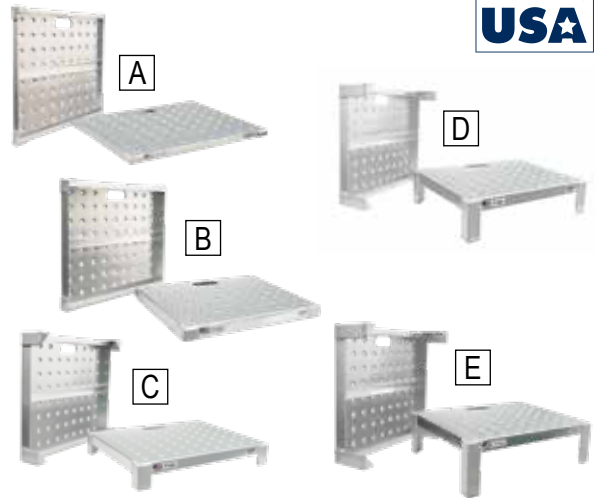

ITEM NO.	PRODUCT	DIMENSIONS	SHIPPING WT.	EACH
3775 00861	A. 1" Ergo Stand	.24" x 20" x 1"	10 lb.	\$300.08
3775 00891	B. 2" Ergo Stand	.24" x 20" x 2"	11 lb.	310.13
3775 00881	C. 4" Ergo Stand	.24" x 20" x 4"	12 lb.	329.96
3775 00871	D. 6" Ergo Stand	.24" x 20" x 6"	13 lb.	340.07
3775 0090	E. 8" Ergo Stand	.24" x 20" x 8"	14 lb.	349.86

Ergo2000 Stand with KorDek-II Grating

- Fiberglass grate is gritted on both sides and can be used with or without the stainless steel stand for a comfortable anti-slip surface.
- Stand is easily adjustable from 4-1/4 to 17-1/4 inches.
- Stainless steel frame with a load capacity of 900 pounds.
- Shipping Weight: 125 pounds.



4-1/4" to 17-1/4" adjustable height.

► SEE PAGES 269 - 271

For More Ergonomic Stands and Mats

ITEM NO.	PRODUCT	EACH
3523 6543	Ergo2000 2' x 4' Stand (includes grating)	\$1,975.56



Fiberglass, Square Grid Floor Grating

- Weighs about one-quarter as much as steel grating.
- Available with a grit top or a concave, plain meniscus top.
- Integral grit top surface provides outstanding anti-slip protection for workers.
- Unlike metal grating, GatorGrate does not rust, never needs painting and is corrosion-resistant.
- Easy-to-clean. Smooth, tapered bars allows debris that enters the top to come out of the bottom.
- Can be easily cut with ordinary hand tools, using a masonry, carbide tip blade or diamond edge.



F.O.B. FACTORY



NOTE: More sizes available. Call for more information.

1-Inch Grating Slip-Resistant Grit Top

ITEM NO.	SIZE	COLOR	EACH
0760 0022	1" x 4' x 12'	Gray	\$933.94
0760 0023	1" x 4' x 12'	Green	933.94
0760 0024	1" x 4' x 12'	Yellow	933.94
0760 0026	1" x 3' x 10'	Green	590.06
0760 0027	1" x 3' x 10'	Yellow	590.06

1" x 5" x 10" available. Call for details.

1-Inch Grating Slip-Resistant, Plain Concave Meniscus Top

ITEM NO.	SIZE	COLOR	EACH
0760 0004	1" x 4' x 12'	Gray	\$844.99
0760 0005	1" x 4' x 12'	Green	844.99
0760 0006	1" x 4' x 12'	Yellow	844.99
0760 0009	1" x 3' x 10'	Yellow	565.45

1" x 5" x 10" available. Call for details.

1-1/2-Inch Grating Slip-Resistant Grit Top

ITEM NO.	SIZE	COLOR	EACH
0760 0031	1-1/2" x 4' x 12'	Gray	\$1,112.55
0760 0032	1-1/2" x 4' x 12'	Green	1,112.55
0760 0033	1-1/2" x 4' x 12'	Yellow	1,112.55
0760 0034	1-1/2" x 3' x 10'	Gray	780.40
0760 0035	1-1/2" x 3' x 10'	Green	780.40
0760 0036	1-1/2" x 3' x 10'	Yellow	780.40

1-1/2" x 5" x 10" available. Call for details.

1-1/2-Inch Grating Slip-Resistant, Plain Concave Meniscus Top

ITEM NO.	SIZE	COLOR	EACH
0760 0013	1-1/2" x 4' x 12'	Gray	\$1,134.05
0760 0014	1-1/2" x 4' x 12'	Green	1,134.05
0760 0015	1-1/2" x 4' x 12'	Yellow	1,134.05
0760 0016	1-1/2" x 3' x 10'	Gray	762.41
0760 0017	1-1/2" x 3' x 10'	Green	762.41
0760 0018	1-1/2" x 3' x 10'	Yellow	762.41

1-1/2" x 5" x 10" available. Call for details.

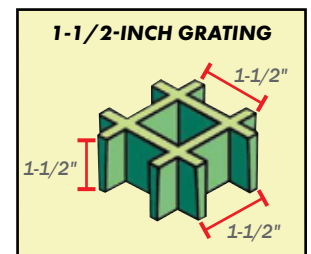
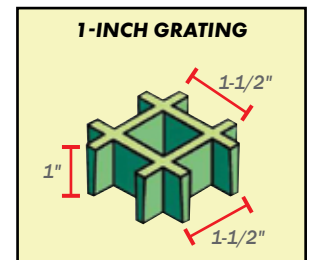

Scotch[®]

Box Sealing Tape 311+



**Extreme
performance.**

Even in cold temperatures.
Even on highly recycled
corrugated boxes.



SHIPPING

FIND IT FAST

Tape and Dispensers	588-590
Carton Sealing Tape	588-590
Masking and Cold Temperature Tape	589
Duct and Electrical Tape	589
Filament Tape	590
Machine Tape and Tape Machines	590
Stretch Film and Dispenser	591
Twine and Twine Knives	591
Cuts+More™ Scissors	592
Hot Melt.	592
Temperature Control Packs	592
Utility Knives	593
Machine and Hand Strapping	594
Dock Bumpers, Chocks and Load Bars	595
Pens and Markers	596



Pistol Grip Tape Dispenser

- For 3-inch core diameter tape rolls.
- Fits 48 mm (2 inch) width tapes.
- Pistol grip with adjustable brake, dispenses and cuts tape.

NOTE: Tape rolls sold separately.

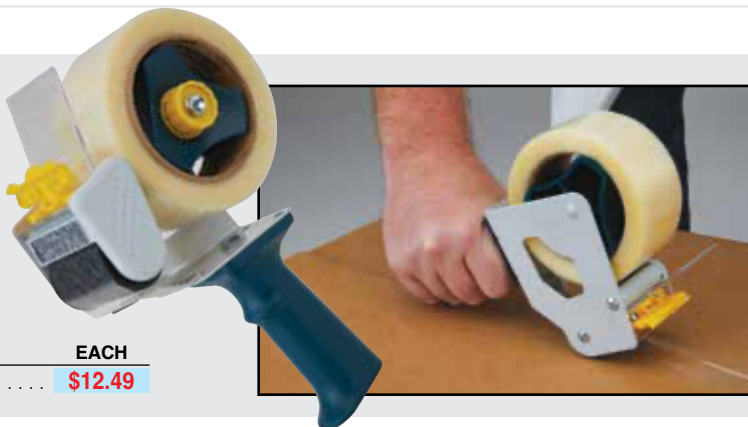

ITEM NO.	PRODUCT	EACH
H350 00021	Tape Dispenser	\$12.49



Scotch® High Tack Box Sealing Tape 311+



- High performance, high tack industrial packaging tape designed for cold and damp temperatures.
- Great for box sealing, splicing, recoupage and demanding packaging applications.
- Excellent performance over broad temperature ranges, even below freezing.
- Quick and easy application by hand, manual dispensers or 3M-Matic™ Case Sealers.
- Adheres to highly recycled corrugated boxes. • Available in 48 mm and 72 mm widths.
- Core diameter: 3 inches.

NOTE: Can be applied at cold temperatures of 20-50 °F and performs at temperatures below 32 °F.



Machine Size Rolls

ITEM NO.	PRODUCT	QTY.	CASE
6655 3830	48 mm x 914 m	6 Rolls/Case	\$197.35
6655 3831	48 mm x 1,500 m	6 Rolls/Case	282.21
6655 3638	72 mm x 914 m	4 Rolls/Case	203.04
6655 4826	72 mm x 1,500 m	4 Rolls/Case	569.89

Hand Size Rolls

ITEM NO.	PRODUCT	QTY.	EACH
6655 38281	48 mm x 100m	36 Rolls/Case	\$4.51
6655 38781	72 mm x 100m	24 Rolls/Case	4.96

Scotch® Box Sealing Tape 371, Machine Length



- Specifically designed for flexibility and conformability under stress.
- 1.8 mil industrial grade polypropylene film packaging tape with synthetic rubber adhesive.
- Meets FDA requirements for indirect food contact.
- This tape resists abrasion, moisture, chemicals and scuffing for long-lasting performance.
- Adheres instantly to a variety of surfaces, including fiberboard.
- Roll to roll consistency increases productivity for improved unit costs.
- Edge tear and split resistant. • Width: 48 mm.
- Tensile strength 22 pounds/inch.
- Core diameter: 3 inches.
- Available in two lengths: 914 m/1,000 yards; or 1,828 m/2,000 yards.



ITEM NO.	PRODUCT	QTY.	CASE
6655 2371	48 mm x 914 m	6 Rolls/Case	\$343.82
6655 0672	48 mm x 1,828 m	4 Rolls/Case	397.35

Colored Carton Sealing Tape, 2 Mil

Flexible polypropylene film is moisture and abrasion resistant.

- Polypropylene film backing is strong and resists heat, cold and UV radiation.
- Water-based acrylic adhesive is bonded to the film for superior performance.
- Operating temperature range: -30 °F to 200 °F (-35 °C to 93 °C).
- Core diameter: 3 inches. • Width: 48 mm (approx. 2 inches).
- Length: 100 m (110 approx. yards).



▶ 36 ROLLS PER CASE.

ITEM NO.	COLOR	EACH
3957 40101	Red	\$7.95
3957 04041	Blue	7.95
3957 04081	Yellow	7.95
3957 13241	White	7.95

Industrial Strength Masking Tape

- Non-staining tape can be used in temperatures from 50 °F - 180 °F.
- Utility grade masking tape designed for routine packaging, sealing and labeling.
- Core diameter: 3 inches.

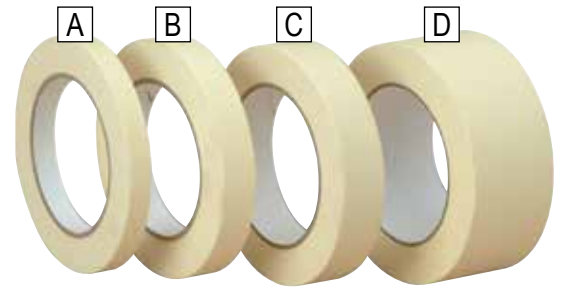

NOTE: Not Intended for Freezer Use.

ITEM NO.	PRODUCT	EACH
3957 72211	A. 1/2" x 180', 12 mm (72/Case)	\$1.95
3957 72171	B. 3/4" x 180', 18 mm (48/Case)	2.85
3957 72021	C. 1" x 180', 24 mm (36/Case)	3.25
3957 72011	D. 2" x 180', 48 mm (24/Case)	5.65

Multiple Roll Tape Dispensers

Easily dispense multiple rolls of tape from one convenient location.

- Dispenser has screw holes so that it can be securely mounted to tabletop. (Mounting hardware not included).
- Available in two sizes: Smaller dispenser holds any combination of tapes up to 4 inches wide. Larger dispenser holds up to 6 inches wide.

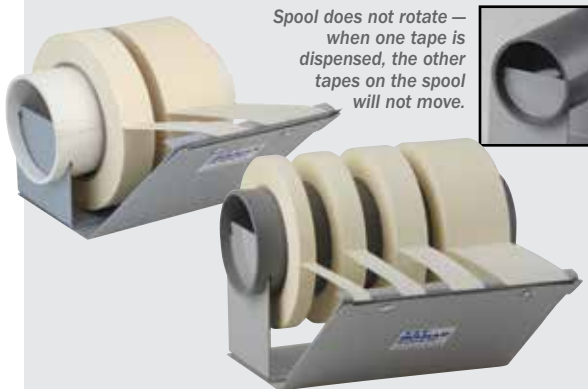

Spool does not rotate — when one tape is dispensed, the other tapes on the spool will not move.

ITEM NO.	PRODUCT	EACH
2330 74041	4" Dispenser	\$69.25
2330 74061	6" Dispenser	78.70

Cold Temperature Tape

Super strong adhesive for wet and cold temperatures.

- Sticks in cold, wet applications.
- 3/4 inch x 180 feet, 18 mm x 55 mm.
- Core diameter: 3 inches.



▶ 48 PER CASE.

ITEM NO.	PRODUCT	EACH
6655 55931	Cold Temp. Tape	\$4.81

Scotch® Clear, Low-Temp Freezer Tape



- Suitable for hard to stick surfaces including cold, damp environments with temperatures down to -20 °F.
- Meets FDA guidelines for indirect food contact.
- Core diameter: 3 inches.
- Width: 48 mm (approx. 2 inches).
- Length: 100 m (approx. 110 yards).



▶ 36 PER CASE.

ITEM NO.	PRODUCT	EACH
6655 61801	2.3 Mil	\$6.55

All Purpose Duct Tape

Tears by hand providing easy application and handling.

- Aggressive, synthetic rubber adhesive provides instant adhesion to a wide variety of surfaces.
- Temperature range: 32° to 160 °F.
- Tightly woven scrim for a high tensile strength.
- Each roll is individually wrapped.
- 9 mil. • Color: silver.
- Roll length: 180 feet (54.8 m).
- Core diameter: 3 inches.



▶ 24 ROLLS PER CASE.

ITEM NO.	PRODUCT	ROLL
3957 49771	1.88" Wide, 48 mm	\$8.95

Scotch® Super 33+™ Vinyl Electrical Tape

Stands up to the elements: from UV rays and moisture to alkalis, acids and corrosion.

- Pressure-sensitive, rubber-resin adhesive with durable PVC backing.
- Compatible with rubber and synthetic splicing compounds.
- UL Listed, ASTM Approved, CSA Certified and RoHS 2011/65/EU Compliant.
- Temperature range: 0 °F to 221 °F.
- Roll length: 76 feet. • Width: 3/4 inch.
- Thickness: 7 mil. • Color: black.



▶ 10 ROLLS PER CASE.

ITEM NO.	PRODUCT	ROLL
6655 15681	Super 33+ Vinyl Electrical Tape	\$14.20

Glass Reinforced Filament Strapping Tape, White

100 pound tensile or breaking strength per inch of width.

- Offers superior sealing, unitizing and bundling of heavy and odd shaped items, as well as pallets.
- Resists splitting when snapped and delamination under severe conditions.
- Roll length: 55 m (approx. 60 yards)
- Core: 3 inches.

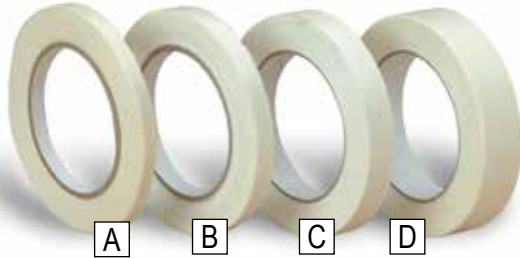

ITEM NO.	PRODUCT	EACH
3957 03131	A. 1/2" Wide, 12 mm (72 Rolls/Case)	\$3.24
3957 03141	B. 3/4" Wide, 18 mm (48 Rolls/Case)	5.25
3957 03151	C. 1" Wide, 24 mm (36 Rolls/Case)	6.31
3957 03121	D. 2" Wide, 48 mm (24 Rolls/Case)	9.28

3-Way Reinforced Box Tape

Reliable water-activated tape bonds instantly!

- 3-way fiberglass laminated between two sheets of kraft paper with a non-asphaltic water-resistant, flexible and non-staining polypropylene, providing strength and durability.
- 56 pound tensile strength per inch of width.
- Core diameter: 1-1/2 inches.
- 72 mm (2.83 inches) wide.
- Roll length: 450 feet.



▶ 10 PER CASE.

ITEM NO.	COLOR	EACH
3957 60441	Natural	\$12.95
3957 60641	White	13.95

Tensitized Strapping Tape, Clear

Lower cost alternative to filament tape.

- Use for strapping, packaging, bundling and palletizing applications.
- Roll length: 55 m (approx. 60 yards).
- 85 pound strength.
- Core: 3 inches.



▶ 144 ROLLS PER CASE.

ITEM NO.	PRODUCT	EACH
3957 12601	1/2" Wide, 2.7 Mil	\$2.25

Carton Sealing Tape Machines

For use with water-activated box tape (see left).

- Standard 1,000-foot roll capability.
- Drip-resistant 60-ounce water bottle.
- Stainless steel "arching" guillotine cutter for the cleanest cutting action.
- Self-centering tape roll side guides adjust from 1 to 3-1/2 inches.
- (B) Electric taping machine features: 30 standard programmed cut lengths from 4 to 90 inches.; Continuous dispensing mode for extra long case lengths.; Twin programmable repeat lengths provide simplicity when "H" sealing or 6-strip sealing.



ITEM NO.	PRODUCT	F.O.B. FACTORY EACH
3957 98001	A. Manual Taper	\$792.10
3957 0241	B. Electric Taper	2,485.60



SIGN UP FOR OUR eDEALS

Get exclusive offers not found anywhere else!

www.bunzlpd.com

Stretch Film and Hand Dispenser

- Premium grade film has unparalleled load-holding force and is highly puncture-and tear-resistant.
- Hand dispenser accommodates film rolls between 12 and 20 inches.



Hand Dispenser

ITEM NO.	PRODUCT	EACH
3105 0800	Hand Dispenser	\$99.95

Machine Film

▶ 1 ROLL PER CASE.

ITEM NO.	PRODUCT	CASE
6431 9049	49-Gauge, Machine, 20" x 9,000'	\$163.80
6431 0045	70-Gauge, Cast Machine Film, 20" x 6,500'	160.65
6431 5080	80-Gauge, Cast Machine Film, 20" x 5,000'	160.12

Hand Film

▶ 4 ROLLS PER CASE.

ITEM NO.	PRODUCT	CASE
6431 1650	39-Gauge, Ecostretch, 16" x 1,500'	\$77.08
6431 1571	70-Gauge, Blown Hand Film, 15" x 1,500'	115.89
6431 00745	70-Gauge, Blown Hand Film, 18" x 1,500'	120.66
6431 0001	80-Gauge, Blown Hand Film, 18" x 1,500'	128.84



Handy Hooker Plastic Wrap Knife

Designed to safely cut film, banding and pallet strapping.

- Quick blade change with the push of a finger.
- Double-honed, single-edge blade.
- Steel head and blade cartridge.
- Impact-resistant handle.



ITEM NO.	PRODUCT	EACH
5415 07001	Handy Hooker Knife	\$7.95

Twine Dispenser

Dispense twine without unraveling.

- Dispenses twine, does not cut twine.



Built-in spring plunger keeps twine secure by preventing spinning.



ITEM NO.	PRODUCT	EACH	NOTE: Purchase twine knives separately.
2330 10081	Twine Dispenser	\$34.60	

Twine Knives

Stainless steel finger twine knife lets you tie and cut in one motion.

- 8 sizes to fit most any finger.
- 1/2-inch cutter blade (non-resharpenable).



▶ 12 PER CASE.

EACH
\$2.65

ITEM NO.	PRODUCT	SIZE (DIA.)
4804 30081	#8	23/32" Dia.
4804 30091	#9	3/4" Dia.
4804 30101	#10	25/32" Dia.
4804 30111	#11	13/16" Dia.
4804 30121	#12	27/32" Dia.
4804 30131	#13	7/8" Dia.
4804 30141	#14	29/32" Dia.
4804 30151	#15	30/32" Dia.

Butcher Twine

- Breaking strengths:
12-ply: 30 pounds
24-ply: 60 pounds
30-ply: 75 pounds



▶ 25 CONES PER CASE.

ITEM NO.	PRODUCT	EACH
7500 02001	12-ply, 3,600 ft.	\$12.02
7500 02091	24-ply, 1,680 ft.	12.02
7500 02131	30-ply, 1,344 ft.	12.02



Cuts+More™ Scissors

These are not your average scissors!

- Fully hardened, precision-ground steel blades stay sharp, even when cutting a wide range of heavy-duty materials.
- Ergonomically sculpted handles provide comfortable use and cutting control.
- Dishwasher safe for easy cleaning.
- Pointed awl tip is perfect for piercing small holes in cardboard, leather, etc.
- Power notch cuts light rope.
- Wire cutter makes it easy to cut wire without damaging the blades.
- Bottle opener makes it easy to open your favorite beverage.
- Sheath protects blades, sharpens scissors and includes a tape cutter for opening boxes.
- Scissors can be taken apart and used as a titanium-enhanced knife that is ideal for cutting large or awkward objects.



► SEE PAGE 392
To See What Else These Scissors Can Do!



Includes sheath with built-in sharpener.

ITEM NO.	PRODUCT	EACH
2182 57101	Cuts+More™ Shears, 9" Length	\$18.85

Hot Melt Adhesive



Hot melt adhesive ensures superior bonding and is perfect for sealing boxes and cartons.

- Forms stronger bonds with less adhesive – reliably closes more boxes using less glue.
- Fast setting time solidifies within seconds of application.
- Convenient soft, cylindrical adhesive pellets.
- Clean and consistent adhesive reduces maintenance, repair and parts replacement on sealing machines.
- 25 pounds.



ITEM NO.	PRODUCT	BOX
H336 0042	Reliant Hot Melt Adhesive	\$99.00

Nordic Ice Temperature Control Packs

Packs are reusable and non-toxic, stay frozen longer than ice. Economical to use.

- When packing, place gel pack on top of product. Leave as little dead space as possible.
- Biodegradable.
- Freezes solid.



NOTE: Sold by case only.

► 36 PER CASE.

ITEM NO.	PRODUCT	CASE
C928 1016	16 oz., 6-1/2" x 5-1/2" x 1" (36/Case)	\$33.05
C928 1024	24 oz., 7-1/2" x 5-1/2" x 1-1/4" (24/Case)	29.05
C928 1048	48 oz., 10-1/2" x 7-1/2" x 1-1/4" (12/Case)	31.30

Concealed Blade Safety Knife

Safely cut through packaging materials, shrink wrap, plastic, film, nylon and more.

- Durable, heavy-duty impact-resistant plastic.
- Multi-point blade positioning.
- Stainless steel replaceable blade.



ITEM NO.	PRODUCT	MFR. NO.	EACH
3078 00271	Concealed Blade Safety Knife	SK-10	\$11.65
3078 00485	Replacement Blades (10/Pack)	SKB-10	6.65

Disposable Concealed Blade Safety Knife

Easier to pull. Safer to cut.



- Concealed blade reduces the chance of injuries.
- Nose can act as splitter for puncturing and opening packing tape.
- Flow-through cutting channels cut up to 4/25-inch materials.
- Large tethering loop helps avoid loss.
- Stainless steel blade for a long blade life.



ITEM NO.	PRODUCT	MFR. NO.	EACH
3078 00581	Concealed Blade Safety Knife	SK-15	\$3.95

Lizard Safety Knife



Eliminates all loose and broken razor blades — and the injuries associated with them.

- Constructed of high-impact, shatter-resistant plastic and specially formulated surgical stainless steel resists corroding.
- Will bend, not shatter under normal use.
- Can be used with either hand.



Safety blade guard automatically retracts after use.



▶ SOLD PER BOX OF 6 KNIVES.

ITEM NO.	PRODUCT	BOX
1156 00365	Safety Knife	\$23.81

Auto-Retractable Safety Knife

- Hole on the end allows easy storage and accessibility.
- Blade automatically retracts when toggle switch is released.



Handy blade dispenser available in boxes of 100.



ITEM NO.	PRODUCT	EACH
3106 4040	Retractable Safety Knife	\$11.89
1060 02405	Replacement Blades (Dispenser Box of 100)	16.42

Quickblade® Autoloading Utility Knife

Easy-to-use slider knob automatically loads new blade.

- All metal construction with a one-piece hinge design contains no loose parts.
- 5 blades included with knife — box of 100 replacement blades available.
- Quick and safe blade change without the use of tools.
- Ergonomic rubber handle for secure grip.

▶ 10 KNIVES PER CASE.

ITEM NO.	PRODUCT	EACH
5415 03751	Autoload Knife	\$9.95
5415 00925	Replacement Blades (Box of 100)	14.95



Remove old blade, push slider and automatically load new blade.



Push button to use other side of current blade.



Side-loading blade chamber allows for 5 blades to be stored inside the knife at one time.

Rubber Grip Utility Knife

- Multi-position blade slide.
- Anti-slip cushion grip for exceptional comfort and safety.
- Easy, no-tool blade change.
- Heavy-gauge stainless steel blade channel that holds blade tight.
- Chemical resistant for easy cleaning.
- Highest-grade carbon tool steel snap blades for sharpness and durability.



ITEM NO.	PRODUCT	MFR. NO.	EACH
3078 00391	Rubber Grip Utility Knife	XA-1	\$7.75
3078 00425	9 mm Snap-Off Replacement Blades (5/Pack)	AB-5B	5.55
3078 00435	9 mm UltraSharp, Snap-Off Blades (10/Pack)	ABB-10B	8.45
3078 00445	9 mm Solid Replacement Blades (10/Pack)	A-SOL-10B	5.25



Machine Grade Polypropylene Strapping

- Strapping features stretch and strength characteristics designed to withstand semi-automatic and automatic strapping machines.
- High elongation and recovery with low tension retention for tight, strong and fast strapping.

F.O.B. FACTORY

ITEM NO.	COLOR	WIDTH	CORE	BREAK STRENGTH	ROLL LENGTH	ROLL
7662 8901	Ivory	.3/8"	8" x 8"	300#	12,900 ft.	\$132.89
A105 0006	White	.3/8"	8" x 8"	300#	12,900 ft.	177.92
A105 2170	White	.3/8"	9" x 8"	300#	12,900 ft.	202.00
A105 0008	White	.1/2"	8" x 8"	400#	9,900 ft.	165.66



Handy Strapper Kit

For quick and easy strapping applications on the go, without investing in a dispenser or machine.

Kit Includes:

3,000 Feet of 1/2-Inch Black, Polypropylene Strap with 400# Break Strength

Hand Tensioner/Cutter
(300) Steel Buckles

F.O.B. FACTORY

ITEM NO.	PRODUCT	EACH
5509 30001	Handy Strapper Kit	\$118.15



Universal Strapping Truck

- Automatic brake to reduce strap spillage.
- Handles steel and non-metallic strapping.
- Tray for storing tools and seals.
- Heavy-duty tubular frame.
- Accepts 3-inch, 6-inch and 8-inch face coils; 8-inch and 16-inch core sizes.
- Shipping weight: 54 pounds.



ITEM NO.	PRODUCT	EACH
7447 2286	Strapping Truck	\$972.06

Hand Grade Strapping

- Use with 16-inch x 6-inch strapping dispenser and a wide variety of hand tools to strap light to heavy full pallet loads.
- Core size: 6 inches x 16 inches.

NOTE: Cut with strap cutter SHOWN RIGHT.



F.O.B. FACTORY

ITEM NO.	PRODUCT	STRAP	COLOR	EACH
A105 0002	1/2" x 9,000'	300#	Black	\$127.70
5509 0015	1/2" x 5,800'	775#	Green	158.75

Sealer

- Seals 1/2-inch poly and plastic straps only.
- Use with open seals shown below.



F.O.B. FACTORY

ITEM NO.	PRODUCT	EACH
7447 2009	Sealer	\$71.25

1/2-Inch Wire Buckles

- Use with 1/2-inch polypropylene strapping — for both hand or tool tensioning.

NOTE: Use with the tensioner SHOWN ABOVE.

▶ 1,000 PER CASE.



F.O.B. FACTORY

ITEM NO.	PRODUCT	CASE
A105 0003	1/2" Wire Buckles	\$94.74

Tensioner

- High quality tensioner tightens and cuts 1/2-inch plastic straps.

NOTE: Use with wire buckles SHOWN BELOW.



ITEM NO.	PRODUCT	EACH
7447 2008	Tensioner	\$149.35

Strap Cutter

- Spring loaded for one hand operation.
- Cuts straps of up to 3/4 inch.
- Cuts hand-grade strapping.



F.O.B. FACTORY

ITEM NO.	PRODUCT	EACH
7447 2015	Strap Cutter	\$122.29

1/2-Inch Open Seals for Plastic Strapping

- For use with a standard sealer.
- 1/2-inch polypropylene and polyester sealer.

NOTE: Use with the sealer SHOWN ABOVE.

▶ 1,000 PER CASE.



F.O.B. FACTORY

ITEM NO.	PRODUCT	CASE
A105 0004	1/2" Open Seals	\$117.44

Dura-Soft Bumper™

Maximum dock protection available in the market – unique loop design absorbs the impact.

- Steel-face plate eliminates wear from up-and-down friction during loading and unloading.
- Weather-resistant and suitable for any heavy-duty material handling areas.
- Can be mounted flush or up to 12 inches above the dock.
- 4-inch rubber pads with loop pad and 3/8-inch steel face.
- Overall thickness: 5-1/2 inches.



F.O.B. FACTORY

NOTE: Specify length when ordering.

ITEM NO.	PRODUCT	EACH
7407 0055	5-1/2" Dura-Soft Dock Bumper	CALL FOR PRICING

Molded Wheel Chocks

- Molded from tough fiber-reinforced rubber compound.
- For use on trailer trucks and other heavy equipment.
- Shipping weight: 10 pounds.
- Available in either black or highly visible orange.
- Optional: 15 feet long, 3/16-inch coil chain with bright zinc finish is available.



▶ 6 PER BOX.

ITEM NO.	PRODUCT	SIZE	EACH
7407 0688	Black Chock	8" x 5-3/4" x 9"	\$41.60
7407 0689	Orange Chock	8" x 5-3/4" x 9"	42.95
7407 0670	Optional Chain for Wheel Chock		24.95

Rubber Dock Bumpers

- Absorbs over 80% of truck impact and shock to protect docks, buildings and cargo areas.
- Tough plies of truck tire material eliminate chipping and abrasion unlike standard rubber bumpers.
- Anchored through thick steel angles to provide stability and retain shape.
- Weather-resistant, anchor bolts protected by 3 inches of rubber.
- Bumpers available with angles (equipped with 1/4-inch steel angles at both ends) or with flat plate for use with dock levelers (optional 1/4-inch flat steel plate for one or both ends).
- 6 inch laminated, 9 inch and 10-1/2 inch thicknesses also available.



NOTE: Specify length when ordering.

F.O.B. FACTORY EACH

ITEM NO.	PRODUCT	F.O.B. FACTORY EACH
7407 0045	4-1/2" Laminated Dock Bumper	CALL FOR PRICING
7407 1210	Extra-Thick 12" Dock Bumper	CALL FOR PRICING

Chocked Area Safety Sign



- Constructed of 20-gauge steel.
- Measures 10 inches x 14 inches.
- Highly visible yellow and black safety design.
- Four pre-drilled holes for easy installation.

ITEM NO.	PRODUCT	EACH
7407 1014	Safety Sign	\$24.95

Saf-T-Lok Steel Tube Load Lock Bars

Durable steel bar is designed for quick and easy installation or removal.

- High-strength steel tubing features a steel handle housed in a cast aluminum housing.
- Molded pivoting rubber feet grip firmly to trailer walls, yet won't scuff and will remain pliable even at low temperatures.
- Load lock adjusts from 89 inches to 105 inches.
- Shipping weight: 12 pounds.
- Handle and trigger release are easy to use, even with gloved hands.



▶ 6 PER BOX.

ITEM NO.	PRODUCT	EACH
7514 00851	Saf-T-Lok Load Lock	\$46.60

Galvanized Steel One-Piece Jack Bar

Reverse ratcheting is no longer required – a patented quick-release feature closes the bar with one easy step.

- Constructed of square galvanized steel tubing.
- Jack bar adjusts from 86 to 104 inches.
- Shipping weight: 16 pounds.



▶ 6 PER BOX.

F.O.B. FACTORY EACH

ITEM NO.	PRODUCT	F.O.B. FACTORY EACH
7514 0101	Steel Jack Bar	\$93.30

Metal Detectable All Stainless Steel Retractable Ballpoint Pen

The heavy-duty stainless-steel barrel with a knurled grip ensures superior writing stability. Rugged and sturdy, this ballpoint pen can take a beating and is ideal for factory environment.

- Durable stainless steel is metal detectable – tip, barrel and clip.
- Secure knurled grip.
- Silent retractable plunger.



All Stainless Steel Black Refill

The steel ballpoint uses smooth, easy-glide ink for a more controlled writing experience.

- Premium all-metal refill is easily metal detectable making it ideal for factory settings.
- Effortless refill process makes it great for everyday use.

ZEBRA



ITEM NO.	PRODUCT	EACH	ITEM NO.	PRODUCT	EACH
M268 00011	All Metal Stainless Steel Retractable Pen . . .	\$7.95	M268 00021	All Metal Stainless Steel Refill, 0.8mm Black. . . .	\$2.95

Sharpie Permanent Markers

- Fast-dry, non-smearing, waterproof ink.
- Wedge-shaped tip.
- Ink color: black.
- Choose from fine point or king size.

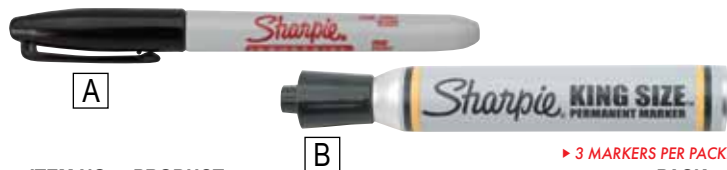

ITEM NO.	PRODUCT	PACK
6259 37635	A. Sharpie, 3-Pack	\$7.95
▶ 3 MARKERS PER PACK.		
ITEM NO.	PRODUCT	BOX
6259 5001	B. Sharpie, King Size	\$24.95
▶ 12 PER BOX.		

USDA/FDA Food-Safe Markers

- Heavy-duty ink writes on oily, greasy and rusty surfaces.
- Ink is USDA authorized for use in Federally Inspected Meat and Poultry Plants.



ITEM NO.	INK	PACK
3199 40105	Black	▶ 12 PER PACK. F.O.B. FACTORY PACK \$50.95
3199 40205	Blue	
3199 40305	Green	
3199 40405	Red	



Refillable Markers

- Replaceable tips, refillable barrel.



ITEM NO.	PRODUCT	EACH
3599 9438	Refillable Marker	\$42.46
3599 94405	Round Replacement Tip (12 per Box).	52.95
3599 00011	1-qt. Black Ink	89.95

Metal Detectable Permanent Markers

- Permanent marker has a blue, metal detectable body.
- Removable cap fits snugly onto base of marker.
- Non-toxic, xylene-free, low-odor.



ITEM NO.	PRODUCT	BOX
B639 3900	Black Ink	\$67.95
B639 3901	Red Ink	67.95
▶ 10 MARKERS PER BOX.		

DYKEM® SAFE-MARK NSF Certified General Purpose Markers

Designed for marking on food contact surfaces used in processing, transporting or holding food products.

- Valve action mechanism prevents ink from drying when the cap is off.
- General purpose, quick-drying permanent ink marker.
- Marks withstand temperatures spanning -20 °F to 475 °F.
- “Locked nib” prevents tip from falling out and into processing Operations.
- Ideal for most surfaces including metal, glass, plastic, cardboard, rubber, shrink film, stretch wrap, etc.



ITEM NO.	PRODUCT	EACH
3112 09071	Black	\$6.59
▶ 12 PER BOX.		

A

Absorbent	
Compound	6, 280, 580
Soaker Pads	499
Drum Cover Pads	578
Pads	578
Socks	578
Acid	
Cleaners	134, 136, 185, 560
Suits	92
Adhesive(s)	558, 584, 592
Insect Trap Refills	582-583
Aerator, Faucet	177
Aero-Tote Container	219
Air	
Door	543
Gun	153
Hose	153
Nozzle	153
Alcohol, Prep Wipes	286
All-Purpose Cleaners	132, 134, 136, 138-140
Alpet Sanitizers	162
Aluminum	
Bag Clips	494-495
Bus Cart	192
Clean-up Cart	270
Clipboard, Covered	509
Container Opener	256
Dollies, Freezer	201
Dollies, Platter	202, 204, 206
Dollies, Tote	190, 193-195, 197-200
Dolly, Dough Box	207
Dolly, Drum	260
Door Pull, Big Foot	547
Dunnage Racks	226-227
Equipment Stand	211
Ergo Stands	226, 269, 585
Ext./Telescoping Handles	110-111, 116, 123
Foil	503
Knock Down Tables	197, 234, 236
Ladders	570
Lockout Hasps, Spark-Resistant	278
Locks	279
Mat Rack, Wall Mount	271
Pallets and Movers	215, 225
Racks	204, 206, 237
Ramps	222
Scabbards	371
Scoop	250
Shelves	228-229
Shovels	244
Smokesticks	472
Spray Nozzle	146, 149
Stock Truck	212, 214
Strip Door Mounting Hardware	540
Stuffing Tubes	464
Totes	190
Traffic Doors	548
Trash Trucks	260
Tray Cart, 3-Tier	207
Analyzers	
Fat	513
Gas	512
Anti-Fog	
Face Shield	299, 311
Glasses, Safety	11, 290-295, 297
Goggles, Safety	297-298

Wipes	296
Anti-Slip Compounds	280-281
Antibiotic, Ointment	282-283, 287
Apron Clips	79
Apron(s)	
Boning, PVC	333
Cotton Bib	84
Cut-Resistant	332
Disposable	73-75
Endeavor	75
Endurosaf®	75
Flame Retardant	336
Hycar	77
Metal Mesh, Stainless Steel	332
Metal Mesh, Titanium	332
Neoprene	76
Nitrile	78
Poly/Nylon	79
Polyethylene	73
PVC	79
Safety, Heavy-Duty	333
Tyvek	84
Urethane	79
Vinyl	74, 77
Vinyl Replacement	74
Welding	336
Arm Guards	334-335
Artery Needles	459-460
Ash Trays	263
Aspirin	282-283, 288
Axes	9, 366-367

B

Back Supports	266-267
Bacon Hangers	472
Bag(s)	
Can Liners	259
Clipper, Poly Bag	494-495
Clips	494-495, 502
Cook Chill	490
Shrink	483-486
Shrink, Custom Printed	487
Deli SlideLock	504
Drum Liners	222
Duffel	85
Modified Atmosphere	490
Openers	500
Paper	505
Poly	8, 492-493
Poly Food, Low-Density	501
Sealers	491-493
Stapler	495
Sterile Sample, Whirl Pak®	511
T-Sacks, Plastic	505
Taping Machine	495
Ties	502
Ziploc®	504
Zipper, Vacuum	8
Baker's	
Gloves	42-43
Pads	44
Sleeves	44
Balancers	429
Retractors	429
Bandages	282-286
Bandsaw Blades	396, 400-402
Buster Saw	435

Barrier System	562
Bars, Load Lock	595
Basket	
Chilltote™	200
Freezer	201
Shopping	505
Batteries	566
Reference Chart	566
Beard	
Guards	71
Nets	71
Restrains	71
Belt	
Grinder	388
Lifting Support	266-267
Bench	
Brush	97, 99-100
Scales	518-519
Squeegees	105
Benches	561
Bib	
Acid Suit	84
Aprons	84, 333, 336
Insulated	34
Sanitation	93
Bi-Metal Thermometers	530-531
Big Foot Door Pull	184, 547
Big Red® Thermometer	525
Bin(s)	
Collapsible	221
Combo	218
Dust	112
Foldable	222
Ingredient	208-209
Shipping Container	224
Storage, MACX™	220
Tote	188-192, 198-201
Waste	183, 263
Biohazard	
Clean-Up Kit, Spill Hero	280, 579
Disinfecting Absorbent	280, 580
Blade(s)	
Bandsaw	396, 400-402, 435
Breaking Saw	434
Circular	402, 404-405
Dehider	411, 427
Handsaw	443
Involute	411
Peeler	410
Scalpel, Replacement Poultry	361
Rib Pulling	410, 444
Skinner	411, 444
Slicing	410
Specialty	402, 406-411
Tray Pack	403
Wellsaw	431-433
Utility, Replacement	393-395, 593
Bleach	137, 141, 185
Block	
Pinch	450
Sets, Knife	368
Toilet, Cherry	184
Bloodborne Pathogen Response Kit	282
Blood	
Disinfecting/Spill Kits	280, 282, 579-580
Stopper Compress	285
Blowers	572
Boil-In	478

- Bollard Covers 561
- Bone
Collector 398
Discs, Plastic 480
Dust Removers 373
Guards, Waxed 480
Shields 480
- Boning
Aprons 333
Hooks 372
Knives 9, 341-342, 344, 346-360, 364-369
- Books 420
- Boot(s)
Brush 26
Comparison Chart 12
Covers 10, 30-31
Dip Mat 27, 145, 271
Dunlop® Acifort® MetMAX 22
Dunlop® Chesapeake 16
Dunlop® DuraPro® 17
Dunlop® Economy 18
Dunlop® PolyFlex 3 19
Dunlop® PolyGoliath 18
Dunlop® PolySteel 19
Dunlop® Purofort® FoodPro 14-15
Dunlop® Purofort® RigPRO 22
Dunlop® White, Steel Toe PVC 16
Insoles 24
Insulated 20, 23
Liners 25
Oliver by Honeywell 23
Protectors, Steel 426
Racks 25-26
Rocky Brands Servus® Neoprene 20-21
Rocky Brands XtraTuf® Neoprene 20
Socks 25
Stand 25
Wash Station 27
Work Shoes 23
- Booties, Tyvek® 30
- Bottles, Spray 145, 567
- Bouffant(s)
Caps 7, 11, 69-71
Dispensers 70
- Box(es)
Cutters 593
Dough 207
Food 206
Heaters 179
Lock, Standard Group 277
Sealing Tape 588
Sterilizer 178
- Breaking
Knives 341, 346-347, 350, 353, 355, 357
Saw 434
- Brine
Pumps 457
Tester 457
- Brooms
Angle 113
Color-Coded 113-115
Corn 114
Duo-Sweep 112
Dust Pan 112
Lobby 112
Omni-Sweeps 112
Plastic 115
Push 115
- Ultra Safe Technology (UST) 115
- Brown Duck Clothing 32-33
- Brush(es)
Bake Pan Lip 100
Bench 97, 99-100
Boot n' Shoe 26
Bottle 102
Counter 103
Detail 103
Flo-Thru 124
Floor Scrub 125-126
Floor Drain 102
Hand, Round 96
Hook 103
Nail 168
Scrub 98-100
Stencil, Self-Inking 443
Tank 96, 101
Tile and Grout 101
Toilet 184
Tube 97
Utility 103, 567
Valve and Fitting 101-102
- Bucket(s)
Flat-Sided 254
Mop 116, 121
Opener 256
Round 121, 255-256
- Buckles, Wire, Strapping 594
- Buggies, Dump 234
- Bulbs
Insect 552, 582-583
LED 552
Shatter-Coated 552, 582-583
- Bump Caps 312
- Bumpers, Dock 595
- Burn
Spray 287
Treatment, First Aid 282-283
- Bus Cart 192
- Butcher
Frocks 86-87
Jacket 84
Knives 351, 354-358, 365-367
Paper 8, 496
Paper Cutter 496
Twine and Dispenser 502, 591
Steels 381-382
- C**
- Cabinets
Mobile Storage 571
Modular Storage 228
- Cable Lockout, Adjustable 278
- Caddy
Drum 259
Supply 145, 567
- Calculator 509
- Calibration Chart, Thermometer 534
- Calibrators 535
- Camo
Locker Paper 8, 496
Poly Bags, Game Season 8, 492
Shirred Meat Casings 466, 494
- Can Liners 259
- Caps
Bouffant 7, 69
- Bump 312
- Men's Overseas Style 71
- Stocking, Knit 38
- Carry Caddy 145, 567
- Cart(s)
Bus 192
Floor Mat Clean Up 270
Mobile Work Center 571
Picking/Merchandise 193
Platform/Deck 213
Side Load/Prep 205
Tray 207
Utility 210-211
- Carton Sealing Tape 588
- Cartridges, Respirator 319-321
- Casings
Collagen 465-466
Fibrous 467
Holiday 468
Shirred 466, 494
Tubing Roll 466, 494
- Casters 194, 211, 229-230, 238-241
- Cattle Prods 427
- Ceiling
Covering 557-558
Mop 122
Squeegee 123
System, Suspended 557
- Cement, Tag 443
- Ceramic Steels/Sharpeners 382, 386
- Chains, Scabbard 371
- Char Marking Rings 450, 473
- Chart Recorders 536-537
- Chemical
Dispenser 132
Information Chart 133
Resistant Gloves 46, 55-56
Resistant Suits 92
- Chemicals 132-144
- Chesapeake Boots 16
- Chilltote™ 200
- Chlorine Test Strips/Kit 512-513
- Chocks, Wheel 595
- Chore
Coats 33
Gloves 50
- Chub Film 487
- Cigarette Receptacles 263
- Circular Blades 402, 404-405
- Circular Saw 427
- Clarity™
Bone Shield 480
Cook Chill Bags 490
Custom 478, 487, 493
Low-Density Poly Bags 501
Poly Bags 8, 492-493
Rollstock 488
Shrink Bags 483-487
Vacuum Pouches 476-479
- Clauss
Knives 356
Shears 377-378
- Cleaners 132-144, 185
All-Purpose 132, 134, 136, 138-140
Floor 132, 136, 138-141, 560
Glass 132, 144
Hand 6, 161-166, 567
Production Area 133-134
Smokehouse 139, 473

- Cleaning Pads, Doodlebug™ 127
 Cleaver, Meat 362
 Clipboards 509
 Clipper, Bag 494
 Clips
 Apron 79
 Bag 494-495, 502
 Shelving 230
 Tool 108
 Weasand/Bung 441
 Closet Organizer 108
 Clothing, Cotton Work 84
 Cloths, Cleaning 117, 129-131
 Coatings, Floor 560
 Coats 32-38
 Cold
 Allergy Relief 288
 Dry Storage Thermometer 532
 Freezer Kote 568
 Ink Stamps 448
 Pack 286
 Storage Doors/Latches 550-551
 Temperature Tape 497, 589
 Collagen Casings 465-467
 Collapsible Bins 221
 Color-Coded
 Brooms 113-115
 Boot Covers 31
 Bouffants 69
 Brushes 96-103, 124-125
 Bump Caps 312
 Cutting Boards 237
 Drums 257-258
 Dustpans 112-113
 Floor Brushes 125-126
 Handles 104, 106, 109-111, 118, 243, 249
 Hard Hats 313
 Hoes 243
 Jugs 255
 Knives 358, 362
 Locks 279
 Mop Buckets 121
 Mops 117-119
 Nozzles 147-149
 Pails 254, 256
 Pallets 224
 Scoops 251, 253
 Scrapers 109, 242-243, 248
 Scrub Pad System 127
 Shovels 246
 Spatulas 242-243
 Squeegees 104-106, 123
 Stopwatches 510
 Totes 188-189, 192
 Wall Brackets 108
 Combo
 Bins 218
 Liner Bands 223
 Liners 223
 Cones
 Deboning 450
 Safety 120
 Container(s)
 Collapsible 221
 Combo 218
 Dust 112
 Foldable 222
 Ingredient 208-209
 Shipping Container 224
 Storage, MACX™ 220
 Tote 188-192, 198-201
 Waste 183, 263
 Container Opener 256
 Cook Chill Bags 490
 Cooking Thermometers 530-531
 Cooler
 Doors and Parts 542-543, 550-551
 Drink, Sqwincher 275
 Jackets 33, 36, 316
 Ramp 222
 Vests 33, 36, 316
 Corners, Stainless Steel 558
 Corn Dog Sticks 375
 Cotton
 Bib Aprons 84
 Butcher Jacket 84
 Duck Insulated Outerwear 32-33
 Frocks 86-87
 Gloves 50
 Mop Head 119
 Work Clothing 84
 Counter/Bench Brushes 97, 99-100, 103
 Counters, Tally 510
 Coveralls
 Disposable 82
 Insulated 32, 35
 Covers
 Bollard 561
 Boot and Shoe 10, 30-31
 Combo Cap 222
 Dolly, Platter 203
 Rib-Eye 480
 Toilet Seat 182
 Cups
 Deli 504
 Measuring 253
 Paper Cone 275, 505
 Curb Ramp 222
 Cure-It Injector 459
 Cures 458
 Curing Pump 459
 Curtain Doors and Walls 542-543
 Custom
 Chub Film 487
 Deli "SlideLock" Bags 504
 Embroidery 35, 87
 GSO Tape 497
 Imprinted Drums 257
 Labels 491
 Poly Bags 493
 Printed Casings 467
 Rollstock 487
 Shrink Bags 487
 Shirred Meat Casing 466, 494
 Stamps/Tattoo 448
 Vacuum Pouches 476-478
 Vertical Form Seal Film 487
 Cut-Resistant
 Aprons 332-333
 Gloves 326-331
 Sleeves 334-335
 Tunic 332
 Cutlery Case 366, 369
 Cutter
 Butcher Paper 496
 Dough 249, 373
 Poly Wrapping Film 498
 Strap 594
 Twine 392, 591
 Cutting Boards 237
D
 Data Loggers 536-537
 Deck Carts 213
 Degreasers 133-134, 136, 138-140
 Dehider
 Blades 411, 427
 Deli
 Bags 504
 Cups 504
 Paper 503
 Platters 203
 Meat Slicer 464
 Denaturant 449
 Deodorant, Metered Spray 182
 Deodorizers 27, 136-137, 182
 Descaler 143
 Desks, Receiving 233
 Detergent
 Dishwashing 143
 Laundry 85, 144
 Dexter®
 Cutlery Cases 369
 Hand Tools 374
 Hooks 372
 Knives 351-355, 360-364
 Sharpener 386
 Sheaths 370
 Steels 380-382
 Dial
 Scales 516-520
 Thermometers 529-532
 Diamond Steels 382-383
 Digital
 Scales 516-519
 Thermometers 525-529, 533
 Dish
 Cloths 129
 Wash Detergent 143
 Disinfectants 27, 132, 136-137, 145, 185
 Dispensers
 Apron 68, 73
 Bouffant 70
 Deodorant Spray, Metered 182
 Earplug 300
 Glove 68
 Hands-Free, Industrial 168
 Jumbo Roll 129
 Pumps, Gallon Bottle 145, 162, 166-168, 576
 Safety Glasses 296
 Sanitizer 163
 Shoe Cover 30
 Soap 164-166
 Stretch Film 591
 Tape 497, 588-589
 Towel/Tissue 180-182
 Twine 502, 591
 Disposable
 Aprons/Gowns 73-75, 80-81
 Clothing 82-83
 Earplugs 11, 301-304, 307
 Gloves 10, 63-66
 Paper Cups 275, 505

- Platter Dolly Covers 203
 Respirators 11, 323-324
 Safety Knives 395
 Shoe and Boot Covers 10, 30-31
 Sleeves 67
 Sweat Band 311
 Diversey™ 132-135, 139-141, 159-160, 185
 Dock Bumpers 595
 Dollies
 Tote 190, 193-200
 Freezer Basket 201
 Platter 202-203
 Pan Rack 204
 Drum 208, 206-261, 577
 Mixer Bowl 207
 Dough Box 207
 Doodlebug™ Cleaning System 127
 Door Pull, Big Foot 184, 547
 Door(s) 538, 540-550
 Air 543
 Cooler/Freezer 550
 Curtain 542-543
 Flexible 545
 Gaskets 584
 Hinges 551
 Interior 549
 Latches 551
 Parts 551
 Mesh 544
 Roll-Up 544
 Strip 541-542
 Traffic 546-548
 Dough
 Boxes and Dollies 207
 Cutter/Scraper 249, 373
 Hoe 243
 Drain
 Brush 102
 Cleaners 142, 185
 Plug 219
 Screen 184
 Drum(s) 186, 256-258, 261
 Backsplash 259
 Caddy Bag 259
 Cover Pads, Absorbent 578
 Dollies 208, 206-261, 577
 Faucet 577
 Liners 259
 Pumps 577
 Stainless Steel Process 255
 Truck 215, 260
 Wrench 577
 Dryer
 Hand 183
 Floor 120
 Room 572
 Duct Tape 568, 589
 Duffel Bags, Clear PVC 85
 Dump
 Buggies, V-Edge 232
 Tubs, Angled 216-217
 Dunlop®
 Acifort® MetMAX Boots 22
 Boot Liners 25
 Chesapeake Boots 16
 DuraPro® Boots 17
 Economy Boots 18
 Insoles 24
 Overshoes 29
 PolyFlex 3 Boots 19
 PolyGoliath Boots 18
 PolySteel Boots 19
 Purofort® FoodPro Boots 14-15
 Purofort® RigPRO Boots 22
 PVC Boots, White 16
 Dunnage
 Racks 226-227
 DuraPro®
 Boots 17
 Insoles 24
 Dust
 Mops 116-117, 123
 Pans 112-113
- E**
 E. Coli Sampling Kit 511
 Ear Band 299
 Earmuffs 7, 308-310
 Earplug(s)
 Dispenser 300
 Disposable 11, 301-304, 307
 FitCheck Solo 300
 Metal Detectable 307-308
 Reusable 305-306, 308
 Eco-Gloves 6, 52
 Economy
 Aprons 79
 Boots 18
 Carton Cutter 393
 Casters 239
 Cutlery 360
 Drum Liners 259
 Gloves 46, 49, 53, 58, 336
 Insoles 24
 Insulated Clothing 36-37
 Rainsuit 88
 Safety Glasses 295
 Sprayers 581
 Squeegees 107
 Totes 189
 Trucks 215
 EdgeMaster™ 396, 400-402, 404, 406, 408, 411
 Elbow Supports 268
 Electric Sharpeners 388-389
 Emergency Exit Signs 556
 Emery Rolls 384
 Endeavor Aprons 75
 Endurosaf® Aprons 75
 Enviro Terra™ Cleaner 6, 133
 Eye
 Wash 289
 Wash Hose 289
 Eyewash Stations 289
 Eyewear
 Dispenser 296
 Protective 7, 291-299
 Straps 7, 296
 Wipes 296
 E-Z Pak Meat Bags 492-493
- F**
 F. Dick
 Knives 357, 361
 Scabbard 370
 Sharpener 388
 Steels 380-383
 Stuffer 469
 Face
 Masks 38, 324
 Respirators 11, 320-324
 Shield 299, 311
 Facial Tissue 183
 Fans 572-573
 Fasteners
 Stainless Steel 559
 Tag 442
 Fat Analyzer 513
 Faucets 169, 177
 Fibrox® Pro Handle Knives 347-349, 359, 368-369
 Field Processing Kit 9, 367
 Film
 Chub 487
 Dispenser and Cutter 498
 Lidding 489
 Rollstock 488
 Shrink 501
 Stretch 591
 Vacuum Skin Packaging (VSP) 489
 Vertical Form Seal 487
 Wrapping 498, 502
 Filters
 High-Capacity 580
 Respirator 319-321
 Finger(s)
 Cots 64, 284
 Plucking and Gun 446-447
 Splint 285
 First Aid Kits 282-283
 Fishing Knife 9
 FitCheck Solo 300
 Flame Retardant Clothing 336
 Flashlights 8, 314, 564-565
 Flexible Doors 543, 545
 Floor
 Brushes 125-126
 Caution Signs 120
 Cleaners 132, 136, 138-141, 560
 Coatings 560
 Concrete Patch 584
 Drain Brush 102
 Grating 585
 Mats 270-271
 Scrapers 109
 Traction Tape 281
 Fly Traps 582-583
 Foam
 Blades, Squeegee 105
 Trays 499
 Foamers 157-158
 Fog Eliminating Cloths 296
 Foil, Aluminum 503
 Foldable Bins 221
 Foot Protection 335, 426
 Fork, Cooks 386
 Fork
 Cooks 374
 Sausage Testing 361, 468
 Stainless Steel 247
 Form Seal Film, Vertical 487
 Forming and Non-Forming Rollstock 487-488
 Forschner 380
 Freezer
 Basket Dollies 201
 Baskets 201

Cleaner	139
Coats	32-38, 316
Coating	568
Doors	550
Door Strips	542-543
Gloves	39
Paper	496
Spacers	223
Squeeze Pops, Sqwincher	274
Tape	497, 589
Totes	201
Trays, Chilltote™	200
Vests	33, 36, 316
Frock Liners	37
Frocks	86-87
Frosts® Mora Knives	343-346, 359, 362, 365
Fryer	
Cleaner	134, 139, 473
Glove	45
Furniture Polish	142

G

Gambrels, Hog	438, 440
Game Processor Field Kits	9, 367
Game Season	8-9, 366-367
Game Skinner Knives	9, 367
Gardner Insect Traps	582-583
Gas Analyzer	512
Gaskets	
Detectomer® Sanitary	449
DIN/ISO	449
Door	584
Gauze	285
Gel Ice Packs	505, 592
General Purpose	132, 134, 136, 138-140
Giesser Knives	355
Glass Cleaners	132, 144
Glasses, Accessories	7, 296
Safety	7, 291-299
Gloves	
Baker's	42-43
Canvas	50
Coated	45-48, 51, 55-57
Cut-Resistant	236-231
Dipped	46, 48, 55, 57
Dispenser	68
Disposable	62-67
Freezer	39
Hi-Viz	39, 47
High Temperature	42-43, 45
Inspector's	54
Insulated	39, 45-46
Jersey	50
Kevlar® Knit	42, 54
Knit	6, 52-54
Knit, Coated	47-48, 51
Latex	55-56, 58-59
Latex Disposable	65
Leather	49, 336
Leather Palm	39, 49
Metal Mesh	10, 329-331
Neoprene	45, 55-56
Nitrile	10, 56, 60-61
Nitrile Coated	45, 47, 56
Nitrile Disposable	63-64
Nylon	47, 54
Poly Disposable	65

PVC Coated	46, 46, 51
Racks	61
Rubber Coated	57
Skinner	57
Tensioner	328
Terry	39, 42-43
Thermal	42-43, 45
Vinyl Disposable	66
Welding	49, 336
Work	49-50
Goggles, Safety	297-298
Gold Metallic Vacuum Pouches	478
Gooseneck Faucet	177
Gowns	
Disposable	80-81
Vinyl Replacement	81
Grabber, NiftyNabber®	267
Granton®	
Edge Knives	348, 355
Branded Knives	358
Steels	380, 382
Grating, Floor	269, 585
Grease	574-575
Gun	574
Green Symbol/Products	6, 52, 140, 162
Grill Cleaner	139, 473
Grinder	
Belts	388
Horns	464
Plates	398-399
Meat	464
GSO Tape/Dispensers	497
Guardian Eye Wash Stations	289
Guards, Arm	335

H

Hairnet and Bouffant Dispensers	70
Hairnets	7, 11, 69-71
Ham	
Bone Discs, Plastic	480
Glaze	454
Overwraps	471
Press	472
Smoking Net	470
Hamburger Paddle	373
Turner	374
Hand	
Brushes	96-102
Cleaners/Soaps	6, 161-166, 567
Dispensers	163-166
Dryer	183
Sanitizers	161-163
Saws	443
Tools	373-374
Trucks	215
Wipes	161, 567
Hand and Nail Brush	168
Handheld Sharpeners	384-386
Handles	104, 106-107, 109-111, 117, 123, 127, 243, 247, 249
Color-Coded	104, 106, 109-111, 118, 243, 249
Drop-In Dunnage Rack	226
Mop	118
Handsaws	444
Handwashing Stations	169
Hangers, Bacon	472

Hanging	
Meat 'S' Hooks	372
Scales	519
Hard Hat(s)	7, 312-313
Accessories	7, 309-311, 314
Earmuffs	309-310
Racks	314
Sweat Bands	311
Visor	311
Harnesses	314-315
Hasps, Lockout	276-279
Headlamps	314, 564
Heaters, Box	178-179
Helly Hanson®	93
Helmets, Welding	336
Hercules™ Rail Switches	437
Hi-Viz Clothing	33, 39, 47, 316-317
Hickory Sawdust	473
High Pressure	
Hose	156
Nozzles	155
Washers	156
High Temperature Gloves	42-43, 45
High-Heat Spoons and Spatulas	253
Hinges, Door	551
Hoe(s)	
Color-Coded	243
Food	243
Hog	
Arm Guard, Header	335
Bell Scraper	444
Gambrels	440
Hide Shaver	411, 444
Paddles	445
Polishing Whips	444
Ring Pliers	470
Scald	444
Tattoo Inks	449
Tattooer	448
Toenail Puller	444
Wash Nozzle	146
Hood	
Acid Suit, Snap-On	92
Insulated, Snap-On	32-34
PVC on Poly, Snap-On	89
Poly/Nylon Snap-On	90-91
Hooks	
Boning	372
Brush Rack	108
Hat Rack	314
Meat Hanging "S"	372
Meat Trees	440
Node	372
Scabbard "S"	371
Stockinette	470, 472
Trolley	438-440
Horns, Grinder	464
Hose(s)	152-153, 156,
Adapters and Acc	124, 148, 150-151, 153
Air	153
Clamp	146
Eye Wash Drench	289
High Pressure	155-156
Hot Water	152-153
Hot Shot® Cattle Prods	427
Hot Water Mixing Station	154
Humane Livestock Handling Book	420
Hunting	8-9, 367

Hurricane Floor Dryer	120
Hycar Aprons	75, 77
Hydration, Sqwincher® Drink Mix	274
Hydrocortisone Cream	287

I

Ice Packs, Gel	505, 592
Ingredient Bins	208-209
Injection Valves	460
Injector, Cure-It	459
Injector Needles	460-463
Ink Stamps	448
Inking Pad	448
Inks	449
INOX Pro®	
Balancers	429
Knives	340-342
Steels	380, 383
Insect Bulbs	552
Bulbs	552, 582-583
Spray	582
Traps	582-583
Insoles	24
Inspector's Gloves	54
Insulated	
Bibs	34
Boots	20, 23
Boot Liner	25
Caps	38
Cooler	275
Coveralls	32, 35
Doors	546
Face Mask	38
Frock Liners	37
Gloves	39, 45-46
Jackets	32-36, 38, 316
Nozzles	146-150
Socks	25
Vests	33, 36, 316

J

J-Fill® QuattroSelect® Dispensing System	132
Jackets	
Acid	92
Butcher	84, 86-87
Hi-Viz	33, 316
Insulated	32-36, 38, 316
Rain	88-91
Sanitation	93
Janitorial and Sanitation Supplies	94-185
Jarvis	414-425, 428, 430-435, 441
Bandsaw, Buster	435
Breaking Saw	434
Circular Saw	427
Dehider	411, 427-428
Skinner	428
Stunners	414-425
Wellsaws	430-433
Weasand/Bung Ring Expander	441
JAX Oils and Lubricants	574-575
Jersey	
Gloves	50
Mops	119
Jugs, Color-Coded	255
Jumbo	
Angle Broom	113

Dust Pan	112
Roll Dispenser	129
Tissue Roll	180
Totes, Poly	190

K

Keel Knife	361
Keelgrid Suspended Ceiling System	557
Kevlar®	
Knit, Gloves	42, 54
Sleeves	334
Kits	
Bag Sealer Starter	491
Biohazard Disinfecting Absorbent	280
Biohazard Clean-Up	579
Caster	211, 229-230, 235
Cationic Test	513
Chlorine Test	513
Concrete Floor Patch	584
C-R-S System	159
E. Coli Sampling	511
First Aid	282-283
Foamer Unit	158
Game Processing	9, 367
Hand and Nail Brush	168
Handy Strapper	594
Hose Accessory	150
Lockout	276
Sanitizer Unit	158
Spill Station	579
Stunner Cleaning	423
Universal Poly Spill	578
Wellsaw Service	431
QuickMount Template	540
Zerk Replacement	574
Kleenex®	183
Knee Pads	269
Knife	
Block Sets	368
Cases	369
Racks	370
Roll Set	369
Scabbards/Sheaths	370-371
Sharpeners/Steels	380-390
Sterilizers and Boxes	178-179
Knit	
Cap	38
Face Mask	38
Gloves	6, 52-54
Knives	340-369
Blunt Tip	341, 347-347
Boning	341-342, 344-360, 364-369
Bread	349, 353, 368-369
Breaking	341, 346-347, 350, 353, 355, 357
Butcher	351, 354-358, 365-367
Catfish	364
Cheese	363
Chef	349-350, 356, 365, 367-369
Cimeter	348, 350, 354-355, 357, 363
Clam	364
Clauss®	356
Color-Coded	358, 362
Cooks	353, 358
Counter	358
Dexter®	351-355, 360-364
Ergogrip	357
F. Dick	357, 361

Fibrox® Pro Handle	347-349, 359, 368-369
Fillet	347, 353, 356, 365, 367
Fish/Fishing	351, 365
Flank	347
Frankfurter	362
Frosts® Mora Knives	343-346, 359, 362, 365
Game Season	8-9, 366-367
Giesser	355
Granton®	358
Granton Edge	348, 355
Gut Knife with Spoon	364-365
Header	344, 352
INOX Pro®	340-342
Keel	361
Lamb	342, 345, 347, 351, 354
Loin	361
Mastergrip	357
Melon	363
Metal Detectable	362
Morakniv	366-367
Mundial	374
Oyster	364
Paring 349-350, 353, 356, 360, 362-363, 368-370	
Pinner	362
Poultry	344, 358-361
Prodex	354
Produce	363
Rosewood Handle	350, 368
Sani-Safe®	352-354, 362-364, 374
Santoku	361, 468
Sausage Testing Knife with Fork	365
Scalloped Edge	353, 362, 374
Scalpel	361, 410
Seafood	364-365
Skinning	342, 345, 347, 351, 353-355, 357, 366-367
Slicer/Carver	348, 355, 358, 368-369
Sliming	364
SofGrip™	355
Specialty	361-363
Steak	354, 358
Sticker/Sticking	345, 362
Superflex	347
Trimmer	344
Turning	362
Twine	392, 502, 591
Utility	393-395, 593
Vegetable	363
Vent	352, 359-360
Victorinox	347-350, 359, 362-364, 368-369
Wood Handles	350-351, 368
X-traFlex	345
Koldwear®	34-35
Koolerwear®	33, 37, 316
Kromer, INOX Pro® Balancers	429

L

Labcoats, Disposable	82-83
Labels	
Custom	491
Safe Handling	499
Ladders	570
Lanyard, Safety	314
Latches, Door	551
Latex	
Finger Cots	64, 284
Gloves	55-56, 58-59, 65

Laundry	
Detergent	85, 144
Pins	85
Trucks	219
Lavatories	170-174
Lavatory	
Valves/Faucets	169, 176-177
Leak Checker	511
Leather Gloves	39, 49, 336
LED	
Fixtures	552-556
Flashlights	8, 314, 564-565
Headlight	314
Light Bulbs	552
Spotlight	8, 565
Legg's Seasonings	452-457
Lens Care	296
Lid Remover	256
Lidding Packaging	489
Lid(s)	
Combo Bin	218
Drum	255, 257-258
Food Storage	206, 252
Ingredient Bin	208
Pail	254
Palletote™	224
Tilt Truck	216-217
Tote	189-190, 192, 198, 201, 219
Transport Storage Tub	191
Waste Container	263
Lifelines	315
Lifting Belts	266-267
Light Bulbs	552, 582-583
Lighting Fixtures	552-556
Liner Holder	262
Liners	
Boot	25
Can	259
Combo Bin	222
Drum	222
Frock	37
Holder, Trash	262
Platter	203, 503
Tote	189
Liquid Smoke	473
Load Lock Bars	595
Loader, Vacuum Pouch	478
Lock Box	277-278
Locker Paper	8, 496
Lockers	561
Lockout/Tagout	276-279
Locks	279
Loggers, Transport	536
Loin Knives	361
Lopping Shear	375
Low-Density Poly Food Bags	501
Lubricants, Oils, Anti-Stick	470, 574-575
Lung Scraper	410, 444
M	
Magnetic	
Knife Rack	370
Wall Mount Barrier System	562
Maple	
Breakfast Seasoning	452
Brown Sugar Snack Stick Seasoning	453
Cures	458

Marinades	455
Marinating Nets	470-471
Markers	443, 481, 508, 596
Mask, Face	38, 324
Masking Tape	497, 589
Mastergrip Knives	357
Mats	
Anti-Fatigue	270
Boot Dip	27, 145, 271
Floor	270-271
Grating	585
Knobby	571
Measuring, Cups	253
Meat	
Bags	492-493
Boats	504
Casings	465-468, 494
Grinders, Electric	464
Hooks	372, 440
Markers/Crayons	443
Netting	470-471
Skewers	375
Slicers	464
Tenderizer	373
Trees	440
Medical Supplies	282-288
Mega-Totes/Dollies	198
Metal Detectable	
Bandages	282
Earplugs	307-308
Gaskets	449
Knives	362, 395
O-Rings	449
Pens/Markers	508, 596
Plug, Drain	219
Scoops	248
Scrapers	242, 248
Shovels	246
Metal Mesh	
Aprons/Tunics	332
Glove Tensioner	328
Gloves	10, 329-331
Sleeves	335
Straps, Replacement	328
Microfiber Cleaning System	116
Mineral Oil	372, 576
Mixing	
Paddles	242-243
Stations	154
Modified Atmosphere Bags	490
Moldings, Vinyl	559
Mop(s)	
Buckets, Pails, Wringers	116, 121
Dust	116-117
Handles	118
Heads	119
Roller and Sponge	122
Multi-Purpose Cleaners	132, 134, 136, 138-140
Multi-Use Steels	383
Mundial	374
N	
Needle(s)	
Artery	460
Holder	460
Injector	462-463, 511
Spray	460

Neoprene	
Aprons	78
Boots	20-21
Gloves	45, 55-56
Sleeves	66
Net(s)/Netting	
Hair/Beard	70-71
Marinating	470-471
Smoking	470-471
Tyers	471
NiftyNabber® Grabber	267
Nitrile	
Aprons	78
Nitrile	10, 45, 47, 56, 60-61, 63-64
Work Shoes	23
Node Hooks	384
Non-Slip	
Compound	280-281
Tape	281
Nozzle(s)	
Air	153
Color-Coded	147-149
High Pressure	155
Insulated	146-150
Water	146-150
Nylon	
Filet Skewers	375
Gloves	47, 54
Rivets	559
O	
O-Rings	449
Oil, Mineral	391, 576
Oils and Lubricants	574-575
Oilstones	390-391
Organizer, Tool	108
Oven Cleaner	134, 139, 473
Overalls	
Acid Suit	92
Insulated	32
Rainwear	88-91
Sanitation	93
Overshoes	29
Overwraps, Ham	471
OxyBaby® Gas Analyzer	508
Oxygen Absorbers	479, 499
Oyster Knives	364
Ozone Machines	183
P	
Packhouse	
Hose, Hot Water	153
Steels	380, 382
Paddles	
Hamburger	373
Hog Scraper	445
Rattle	426
Scraper/Spatula	242-243
Padlocks	279-280
Pad(s)	
Absorbent	578
Baker's	44
Drum Cover	578
Holder	127
Knee	269
Mop	116

- Sanitary 184
 Scrub 127-128, 143
 Soaker 499
- Pail(s)
 Color-Coded 254-256
 Mop 116
 Stainless Steel 255
- Pain Relief Products 24, 287-288
- PaintStik® 443
- Pallet(s) 215, 224-225
 Truck 215
- Pan(s)
 Detergent 143
 Dolly 204
 Dust 112-113
 Lip Brush 100
 Rack 204
 Steam 204
- Panels
 Ceiling 557-558
 Wall 558-559
- Pants
 Cotton Work 84
 Rainsuit 90
- Paper
 Cups, Cone 275, 505
 Cutters 496
 Deli 503
 Freezer 496
 Hat 71
 Locker 8, 496
 Patty 503
 Sacks 505
 Seat Covers 182
 Steak 203, 503
 Tape 286, 590
 Tissue, Toilet 180, 182
 Towel/Tissue Dispensers 180-182
 Towels, Roll 180-181
- Paste, Hog Tattoo 449
- Patty Paper 503
- Peeler Blades 410
- Pens 508
- pH Meters and Testers 513
- Picking
 Carts 193, 212
 Fingers 446-447
- Pinch Blocks and Rollers 450
- Pins
 Laundry 85
 Shroud 444
- Plasti-Dip Coating 568
- Plastic
 Arm Guards 335
 Bag Clips 502
 Bags, T-Sacks 505
 Bone Discs 480
 Buckets 256
 Clipboard 509
 Dunnage Racks 227
 Finger Splints 285
 Lockers 561
 Modular Storage Cabinets 228
 Pallets 224
 Scabbards/Chains 371
 Scoops 251, 253
 Shelving 228
 Shovels 246
- Tape 495
- Plates, Grinder 398-399
- Platform Trucks 212-214
- Platter(s) 203, 207
 Cart, Side Load 205
 Dollies 202-204, 207
 Dolly Cover 203-204
 Liners/Paper 203, 503
- Pliers
 Hog Ring 470
 Weasand Ring 441
- Plugs
 Beef Throat 441
 Drain 219
- Plunger 184
- Polish(ing)
 Cloths 117
 Furniture 142
 Stainless Steel 142
 Whips, Hog 444
- Polyethylene
 Aprons 73
 Boot/Shoe Covers 10, 30-31
 Buckets/Pails 256
 Bump/Hard Hats 312-313
 Combo Bins 237
 Covers/Shields 480
 Cutting Boards 190
 Foamer Units 157
 Food Containers 252
 Gloves 65
 Gowns 80-81
 Liners 189
 Low-Density Food Bags 501
 Meat Bags 492-493
 Pallets 224-225
 Scabbards 371
 Scoops 251
 Sleeves 67
 Slipsheets 223
 Trucks, Tilt/Laundry 217, 219
 Totes 190-192, 198-200, 219, 224
 Tubs 191, 216
 Ziploc® Bags 504
- PolyFlex 3 Boots 19
- PolyGoliath Boots 18
- Polypropylene
 Absorbent Socks 578
 Aprons 78
 Boot/Shoe Covers 30-31
 Bouffants/Beard Guards 69, 71
 Buckets/Pails 254
 Clothing 82-83
 Deli Cups 504
 Dunnage Racks 227
 Dust Pans 113
 Foamer Units 157
 Hand and Nail Brush 168
 Handles 104, 109, 111, 249
 Knife/Tool, Handles 349, 352, 358, 360, 362-365, 372-374, 381
 Mask, Knit Face 38
 Mats, Floor 271
 Rake/Fork 247
 Scoops 251, 253
 Scrapers 242-243, 248
 Shovels 246
 Sleeves 10, 67
- Strapping 594
- Tape 588
- PolySteel Boots 19
- Pouch(es)
 Boil-In 478
 Gold Metallic 478
 Loader, Vacuum 478
 Openers 392, 500
 Safe Handling 477
 Vacuum 476-479
 Zipper 8, 479
- Poultry
 De-Boning Cones 450
 Knives 344, 353, 358-361
 Lung Scraper 410, 444
 Marinating Net 470
 Picking Fingers 446-447
 Seasonings/Marinades 453-455, 457
 Shackles 440
 Shears 376, 378-379, 392
 Shrink Bags 486
- Powder Packs, Sqwincher 274
- Power Sharpeners 388-389
- Prep Cart 205
- Press, Ham 472
- Pressure Washers 156
- Probe Thermometers 525-531, 536
- Prodex Knives 354
- Prods, Cattle 427
- ProSave™ Ingredient Bins 208-209
- Protective Eyewear 7, 291-299
- Pumping Table 461
- Pumps
 Brine 461
 Curing 459
 Dispenser, Gallon 145, 162, 166-168, 576
 Drum 577
 Foamer 157
- Purofort®
 FoodPro Steel Toe Boots 14-15
 RigPRO Steel Toe Boots 22
- Purell®
 Body Fluid Spill Kit 282
 Hand Sanitizer 161-163
 Surface Sanitizer 135
- PVC
 Acid Suit 92
 Aprons 79, 333
 Boots 16, 18, 22
 Bone Shields 480
 Clothing, Protective 93
 Doors/Curtains 541-543, 545, 549
 Duffel Bag, Clear 85
 Eyewear, Protective 297
 Gasket, Door 584
 Gloves 46, 46, 51
 Handles, Steel 381-382
 Overshoes 29
 Panels, Ceiling 557-558
 Rainwear 88-89
 Tape 281
 Work Boots/Shoes 23
 Wrapping Film/Wraper 498, 502



Quaternary Test Strips 512
 Quik-Release™ Mop Handles 118

Quikflo™ Automatic Faucet Control 169
 Qwik Stik™ Zero, Sqwincher 274

R

Racks
 Aluminum 204, 206
 Boot 25-26
 Brush 108
 Dunnage 227
 Earplug 300
 Glove 61, 68
 Hard Hat 314
 Knife 370
 T-Sack 505
Rags, Disposable 117, 129
 Shop 117, 129-131
Rail Systems 436-439
Rainsuits 88-93
Rakes 247
Ramps, Cooler 222
Rattle Paddles 426
Rayovac®
 Batteries 566
 Flashlights 314, 564-565
Receiving Desk 233
Recording Thermometers 536-537
Refinisher, Scraper 237
Respirator Cartridges and Filters 319-321
Respirators 11, 318-324
Restroom Supplies and Cleaners 180-185
Retractors 315, 429
Reusable Earplugs 305-306, 308
Rib-Eye Covers 480
Rib Pulling Handle and Blades 410, 444
Ring Stand, Adjustable 491
Rivets, Nylon 559
Roast Beef Tier 374
Rod, Weasand 441
Roll-Up Doors 544
Roller Mops 122
Rollers, Skinner 450
Rollout Containers 261
Rollstock 487-488
 Black Non-Forming 488
 Custom 487
Rosewood Handle Knives 350, 368
Rubber Coated Gloves 47-48
Rubber Gloves 57-59
Rubs 456
Rust Remover 568

S

Sacks
 Paper 505
 T- 505
Safe Handling, Labels 499
 Paper 496
 Pouches 477
Safety
 Bump Caps/Hard Hats 7, 312-313
 Cones 120
 Glasses 7, 11, 290-297
 Dispenser 296
 Goggles 297-298
 Harnesses 315
 Knives 393-395

Lockout 276-279
 Signs 595
 Tags 277
 Vests 7, 33, 316-317
Salt, Tinted Curing 454
Sanatec® Poly Cutting Board 237
Sani-Safe® Knives 353-354, 362-364
Sanitary Napkins 184
Sanitizers 27, 135, 145
 Dispensing System 132
 Hand 161-163
 Surface 135
 Wipes 135, 161
Sausage
 Testing Knife and Fork 361, 468
 Trucks 231
Sawdust 473
Saws
 Breaking 434
 Circular 427
 Hand 443
 Well 430-433
Scabbards 370-371
 Chains 371
Scales
 Bench 519
 Dial 520
 Digital 516-519
 Food Service 516-520
 Hanging 519
 Washdown 516-517, 519
Scapel Knife 361, 410
Scissor(s) 286, 392, 592
 Paramedic 286
 Sharpeners 384
Scoops 248, 250-251, 253
 Aluminum 250
 Bowl 253
 Color-Coded 248, 251, 253
 Metal Detectable 248
 Poly 251, 253
 Stainless Steel 250
Scouring Pads 128, 143
Scrapers 109, 242-243, 248-249, 373
 Color-Coded 109, 242-243, 248-249
 Cutting Board, Refinisher 237
 Floor 109
 Hog Bell 444
 Hog Hide 411, 444
 Lung 410, 444
 Metal Detectable 242
 Paddle Scrapers 243
 Plastic 248
 Stainless Steel 109, 248-249
 Threaded 249
Scrub Pads and Holder 127
Scrubbers 123, 128, 143
Sealants 558, 584
Sealer and Seals, Strapping 594
Sealers, Bag 491
Seasonings 452-457
Servus® Neoprene Boots, Rocky Brands 20-21
Shackles, Poultry 440
Sharpener
 Ceramic 382, 386
 Electric 384-386
 Manual 343, 374-377
 Oilstone 390-391

Scissors/Shears 384
 Sharpie® Permanent Markers 596
Shat-R-Shield Lights 552
Shears 376-379
Sheath, Knife 370
Sheets, Tiered Chipboard 224
Shelving
 Aluminum 228-229
 Plastic 228
 Wall 228
 Wire 230
Shield, Face 299, 311
Shipping Containers 191
Shirred Meat Casings 466, 494
Shirts, Metal Mesh 332
Shoe and Boot Covers 30-31
Shoes
 Insoles 24
 Work 23
Shopping Baskets 505
Shovels 246
 Color-Coded 246
 Stainless Steel 244-245
Shrink
 Bags 481-487
 Film 501
Shroud Pin 444
Signs, Exit 556
Silicone 558, 575, 584
Sinks 170-174
 Accessories 176-177
Skewers 375
Skinner
 Blades 411
 Gloves 57
 Rollers 450
Skinner 428
Slaughter of Farmed Animals, The, Book 420
Sleeves
 Baker's 44
 Cut-Resistant 334-335
 Disposable 67
 Flame Retardant 336
 Metal Mesh 335
 Neoprene 66
 Polyethylene 67
 Polypropylene Coated 67
 Polyurethane Coated 66-67
 Reusable 67
 Vinyl 67
 Vinyl Replacement 67
 Welding 336
Slicer 464
 Blades 410
Slipsheets 223
Smocks 81
Smokehouse Cleaner 139, 473
Smokesticks 472
Smoking Nets 470-471
Soaker Pads 499
Soap 164-167
 Dispensers 164-166, 168-169
Sockets 241
Socks
 Drum Spill Absorbent 578
 Insulated 25
SofGrip™ Knives 355
Spacers, Freezer 244-245

- Spade 243
Spatulas 243, 253, 374
Specialty
 Blades 406-409
 Knives 361-363
Spices 452-457
Spill Kit/Clean-up 6, 280, 578-579
Spinal Cord Remover 411, 444
Sponges 122-123, 128
 Cellulose 122-123
 Scrub 128
 Stainless Steel 128, 143
Spotlight 8, 565
Spray
 Bottles 145, 567
 Deodorizers 182
 Foamers 157-159
 Needles 460
 Sanitizers 135
Sprayers 576, 581
Squeegees 104-107, 123
 Ceiling 123
 Color-Coded 104-106, 123
Sqwincher® 274-275
Stainless Steel
 Casters 239
 Cleaner 142
 Corners 558
 Dollies 196, 203, 260
 Drums 255
 Dump Buggies 232
 Foot Protectors 335
 Forks 247
 Hoe 243
 Knife Sterilizer Boxes 178
 Lavatories, Sinks 170-174
 Paddles 242
 Pails 255
 Pans 204
 Platters 203
 Polish 142
 Receiving Desk 233
 Scoops 250
 Scrapers 109, 248-249
 Scrubber 128, 143
 Shovels 244-245
 Sinks 170-174
 Sleeves 335
 Spade 244-245
 Tables 235-236, 461, 469
 Trucks 212, 231
 Vats 219
Stamps, Cold Ink 448
Stands
 Boot 25
 Ergonomic 226, 269
Staplers, Bag 495
Steak
 Paper 203, 503
 Tenderizer 458
Steam Table Pans 204
Steels 380-383
 Ceramic 382
 Dexter® 380-382
 Diamond 383
 F. Dick 380-383
 Forschner 380
 Granton® 380, 382
 INOX Pro® 380, 383
 Multi-Use 381, 383
 Mundial 381, 383
 Packinghouse 380-381
 Wooden Handle 382
Stencil Brushes 443
Sterilizer Boxes and Heaters 178-179
Stockinette Hooks 470, 472
Stockinettes 470
Stocking Trucks 212, 214
Stones, Sharpening 390-391
Stopwatches 510
Storage Bins 220-221
 Cabinets 228
Strap Cutter 594
Strapping 594
 Tape 590
 Truck 594
Stretch Film 591
String Knit Gloves 51-53
Strip Doors 540-542
 Material 540-542
 Mounting Hardware 540
 Template Kit 540
Stuffers, Piston 469
Stuffing Tubes 464
Stun Tester 421, 425
Stunner 414-425
 Cleaning Tools 423
 Tester 421, 425
 Vest 426
Sugar Cures 458
Supports
 Back 266-267
 Breaking Saw 434
 Elbow 268
 Wellsaw 431, 433
 Wrist 268
Sweat Bands 311
Sweatshirt 38
Switches, Rail 436-437
- T**
- T-Racks and Sacks 505
Table Tops 237
Tables
 Knock-Down 197, 234-236
 Poly Top 234-236
 Pumping 461
 Stainless Steel 235-236, 461, 469
 Stuffing 236, 469
 Work 234-236, 461, 469
Tag
 Cement 443
 Fasteners 442
Tagging System 442
Tags, Lockout 276-277
 Processing 442
Tally Counter 510
Tampons 184
Tape 281, 286, 495, 497, 588-590
 Box 588, 590
 Carton Sealing 588
 Cold Temperature 497, 589
 Dispensers 497, 588-589
 Duct 568, 589
 Electrical 568, 589
 GSO 497
 Masking 497, 589
 Medical 286
 Poly Bag 495
 Strapping 590
 Traction 281
 Warning 281
Taping Machine, Bag 295
Tattoo Paste 449
Tattooer, Hog 448
Tel-Tru Check-Set
 Calibrators 535
 Well-Inserts 535
Temperature
 Control Packs 505, 592
 Data Loggers 536-537
 Meter 513
Template Kit, Strip Door 540
Tenderizer
 Meat 458
 Three Row 373
Tensioner and Buckles 594
Test
 Kits 511
 Strips 512
Thermocouples 528-529
Thermometers 525-533
 Bi-Metal 530-531
 Big Red® 525
 Calibration 534-535
 Comparison Chart 524
 Cooking 530-531
 Dial 530-531
 Digital 525-529
 Hot Water 532
 Infrared 533
 Long Stem 531
 Non-Contact 533
 Probe Wipes 532
 Probes 528-529
 Recording 536-537
 Refrigerator/Freezer 532
 Shake Down 532
 Wall 532
Throat Plug 441
Tier Roast Beef 374
Tilt Trucks 216-217
Timers 510
Tingley®
 Rainsuits 89-92
 Shoe Covers 31
 Sleeves 66
Tissue
 Facial 183
 Toilet 182
Toenail Puller, Hog 444
Toilet
 Bowl Brush 184
 Cleaner 185
 Plunger 184
 Seat Covers 182
 Tissue 182
 Tissue Dispensers 182
Tongs 374
Tool Holder and Closet Organizer 108
Tools, Hand 373-375
Total Solutions® 135, 140, 144-145
Totes 185-192, 198-201

Aluminum	190
Blemished	189
Chill	200
Color-Coded	188-189, 191-192
Distribution	190
Dollies	193-196, 198-200
Economy	189
Freezer	190, 200-201
Hinged Lid	191
Imprinted	189
Jumbo Poly	190
Lids	189, 190, 192, 198, 201
Liners	189
Mega	198
Mini	192
Super-Duty	191
ToteAll 2000®	188-189
Towelettes, Lens Cleaning	296
Towels	
Dispenser, Paper	180-182
Hand Sanitizing	161
Paper	180-181
Scrubbing	161, 567
Shop	129-131, 161, 567
Traction Tape	281
Traffic Doors	546-548
Transport Loggers	536-537
Traps, Insect	582-283
Trash Can Liners	259
Trash Cans	183, 256-258, 261-263
Tray Pack Blades	403
Trays	
Foam	499
Food	203, 207
Multi-Use	207
Trolley(s)	438-439
Hooks	440
Trucks	
Drum	215
Hand	215
Laundry	219
Pallet	225
Platform	212-214
Sausage	231
Shelf	214
Stainless Steel	212, 231
Stocking	212, 214
Strapping	594
Tilt	216-217
Tub(s)	191, 199, 216
Dollies	199
Tubes, Stuffing	464
Turners	374
Twine	
Butcher	502, 591
Dispenser	502, 591
Knives	392, 591
Twist Ties	502
Tyvek	
Aprons	84
Booties	30
U	
Urethane Aprons	79
Urinal Screens	184
Utility	
Brushes	103, 567

Carts	210-214
Knives	393-395, 593
V	
V-Edge Dump Buggies	232
V-GARD®	
Hard Hats	7, 313
Visor	311
Vacuum	
Pouch Loader	478
Pouches	8, 475-479
Skin Packaging (VSP)	489
Valves	
Injection	460
Lavatory	176
Vats	219
Vests	
Hi-Viz	7, 33, 316-317
Insulated	33, 36, 316
Safety	7, 33, 316-317
Stunner	426
Victorinox	
Knife Case	369
Knives	7, 347-350, 359, 362-364
Vinyl	
Aprons	74, 77
Disposable Gloves	66
Moldings	559
Replacement	
Aprons	74
Gowns	81
Sleeves	67
Visor, Safety	297, 311
W	
Wall	
Covering	558-559
Mount Barrier System	562
Thermometers	532
Warning Tape	281
Wash Stations	172-173
Washdown	
Lights	554-555
Scales	516-517, 519
Washers, High Pressure	156
Waste Receptacles	183, 256-258, 261-263
Watch Cap	38
Water Nozzles	146-150
Weasand	
Clips	441
Ring Pliers	441
Rods	441
Weights, Calibration	520
Welded Aluminum Dollies	193-195, 198-199, 202
Welding	
Clothing	336
Gloves	49, 336
Helmets	336
Wellsaws	430-433
Blades	431, 433
Service Kits	431
Supports	431, 433
Wet Floor Signs	120
Wheel(s)	238-241
Chocks	595
Whips, Hog Polishing	444
Whirl-Pak Bags	511

Wipes	
Alcohol	286
Anti-Fog	296
Antibiotic, Triple	286
Disposable	129
Fog Eliminator	296
Glass	144
Hand Sanitizing	161
Lens Cleaning	296
Multi-Purpose	140
Sanitizer	135, 161
Scrubbing	135, 161, 567
Thermometer Probe	532
WypeAll®	129-131
Wood Handle	
Knives	351
Steels	382
Work	
Boots	23
Clothing	84
Gloves	49-50
Shoes	23
Tables	234-236, 461, 469
WorkHorse®	
Arm Guards	335
Beard Guards	71
Cut-Resistant Gloves	326-327
Disposable Polyethylene Gowns	80
Earplugs	11, 301, 303, 305, 307-308
Face Mask	324
Gowns	80
Hairnets/Bouffant Caps	7, 11, 69-70
Hand Soap	166
Hoods, Poly	71
Lab Coats	83
Latex Gloves	58
Metal Detectable Earplugs	307-308
Metal Mesh	10, 329-332, 335
Nitrile Gloves	10, 60, 63-64
Nitrile Disposable Gloves	10, 63-64
Replacement Straps, Metal Mesh	328
Respirators	11, 322, 324
Safety Glasses	11, 290, 292, 294
Sleeves	10, 67, 335
Tunic	332
Wrapping Film, PVC	498
Wrench, Drum	577
Wrist Supports	268
WypeAll® Wipes	129-131
X	
X-Tra Edge Sharpener	388
XSorb Spill Clean-up	8, 280, 579
Z	
Zerk Replacement Kit	574
Zip Tyer	471
Ziploc® Bags	504
Zipper Pouches	8, 479
Zipper Slidelock Deli Bags	540



5710 NW 41st Street | Riverside, MO 64150
1-800-456-5624 | kochsupplies@bunzlusa.com

FAX: 1-800-329-5624

BILLING/SHIPPING

Bill To: _____

Phone: _____ Fax: _____

Contact: _____

Ship To: _____

Purchase Order #: _____

PAYMENT

Type: AmEx Discover MasterCard Visa

CC #: _____

Exp.: _____ CVV#: _____

For your convenience, we have made ordering simple by accepting all major credit cards including Discover, American Express, Visa and MasterCard. We even accept payments via Telecheck.

FREE SHIPPING*
FREE GROUND SHIPPING
 when you place an order for \$500 or more from
THIS BUYERS GUIDE!

*FREE SHIPPING does not include UPS Next Day Air, UPS 2nd Day or UPS 3rd Day Select. Certain items may not qualify. This offer is good only on orders shipped UPS Ground in the 48 contiguous states. Based on dimensional weight, we will determine the most efficient means of shipment, either UPS or LTL. Products may ship by truckline.

ORDER INFORMATION

ITEM NO.	PRODUCT	QTY.	UNIT COST	LINE TOTAL
ORDER TOTAL**				

**Taxes will be added to order total.

STAY UP-TO-DATE

NEW Address: _____

NEW Phone: _____ NEW Fax: _____

Email: _____ Receive EXCLUSIVE Internet Offers!

NEW/Additional Contacts: _____



BUNZL EXCLUSIVE BRANDS:



CLARITY™
FLEXIBLE PACKAGING

INOXPRO®
CUTLERY

Allegiant
HYGIENE SOLUTIONS

ToteAll 2000®

PROCESSOR'S CHOICE

EdgeMaster™

BIG RED®

KOOLERWEAR®

WE STOCK AND SELL MAJOR BRANDS:



VICTORINOX
SWISS ARMY
FACTORY AUTHORIZED DISTRIBUTOR

JARVIS® **3M**



Remco
a Vikan company

Honeywell **DIXIE**



SANI-LAV
COLUMBIA PRODUCTS



Granton®



MOLDEX



FISKARS®



TINGLEY
est. 1896

DOPON



SERVUS®



TAYLOR

MAPA
PROFESSIONAL

COZZINI PRIME Edge
CUTTING EDGES AND SHARPENING SOLUTIONS



NORTON
SAINT-GOBAIN®

SHOWA

CONTINENTAL
COMMERCIAL PRODUCTS®

OLFA®

Chef'sChoice

Cooper
ATKINS

Frost's
MORA

RAYOVAC



TRAMONTINA

DEXTER
THE EDGE SINCE 1818

ERB®
Safety Products for LIFE.

RACK'EM

Master Lock



BUNZL PROCESSOR DIVISION DISTRIBUTION CENTERS



- SPRINGDALE | ARKANSAS
- FRESNO | CALIFORNIA
- DENVER | COLORADO
- ATLANTA | GEORGIA
- ELDRIDGE | IOWA
- LIBERAL | KANSAS
- AUSTIN | MINNESOTA
- MISSOURI | KANSAS CITY
- NORTH CAROLINA | LUMBERTON
- NEBRASKA | OMAHA
- OHIO | FAIRFIELD
- PENNSYLVANIA | YORK
- TEXAS | DALLAS
- WASHINGTON | SPOKANE

800-456-5624

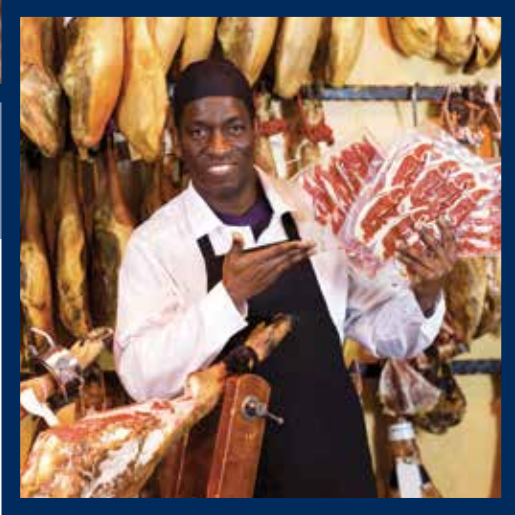

SCAN THE QR TO VISIT
WWW.BUNZLPD.COM